

---

# QUADRENNIAL TECHNOLOGY REVIEW

## AN ASSESSMENT OF ENERGY TECHNOLOGIES AND RESEARCH OPPORTUNITIES



September 2015



## About the Cover

**Image 1:** Image courtesy of Oak Ridge National Laboratory (ORNL). ORNL researchers study the potential of Eastern Cottonwood trees as an alternative biofuel feedstock.

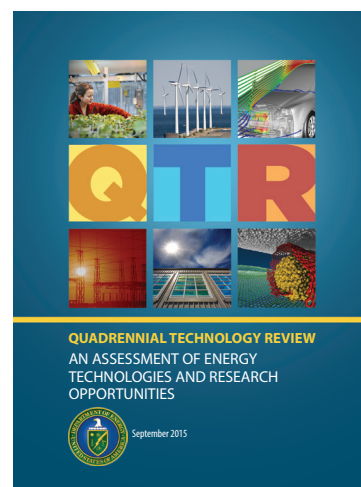
**Image 2:** Photo of utility-scale wind turbines onshore and off the coast of Copenhagen, Denmark. The United States' vast wind resource both on land and offshore represent important options for America's clean energy future. Photo credit iStock 6877403.

**Image 3:** Image courtesy of ORNL and Ford Motor Company. Simulations on ORNL supercomputers helped Ford optimize the effectiveness and fuel efficiency of engine bay designs.

**Image 4:** Image courtesy of Sandia National Laboratories. Working with utilities, states, other government agencies, and technology developers, DOE is facilitating modernization innovations that fully address safety, security, and reliability requirements of the U.S. electricity system.

**Image 5:** Image courtesy of Lawrence Berkeley National Laboratory. Researchers at the window testing facility at Lawrence Berkeley National Laboratory are developing dynamic windows treated with nanocrystals that block heat from the sun when a small electrical current is applied—particularly useful for hot summer days.

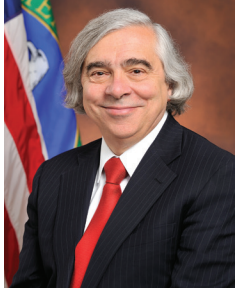
**Image 6:** Image courtesy of Argonne National Laboratory. This large-scale simulation depicts a phenomenon called superlubricity, or a condition of extremely low friction. Argonne scientists used Mira, one of the fastest supercomputers, to identify and improve a new mechanism for eliminating friction, which fed into the development of a hybrid material that exhibited superlubricity at the macroscale for the first time.



# Table of Contents

Message from the Secretary .....	iii
Message from the Deputy Under Secretary .....	v
Acknowledgment from the Under Secretary .....	vii
Executive Summary .....	1
<b>Chapter 1:</b> Energy Challenges .....	11
<b>Chapter 2:</b> Energy Sectors and Systems .....	35
<b>Chapter 3:</b> Enabling Modernization of the Electric Power System .....	53
<b>Chapter 4:</b> Advancing Clean Electric Power Technologies.....	101
<b>Chapter 5:</b> Increasing Efficiency of Building Systems and Technologies.....	145
<b>Chapter 6:</b> Innovating Clean Energy Technologies in Advanced Manufacturing .....	183
<b>Chapter 7:</b> Advancing Systems and Technologies to Produce Cleaner Fuels .....	227
<b>Chapter 8:</b> Advancing Clean Transportation and Vehicle Systems and Technologies .....	277
<b>Chapter 9:</b> Enabling Capabilities for Science and Energy.....	321
<b>Chapter 10:</b> Concepts in Integrated Analysis .....	379
<b>Chapter 11:</b> Summary and Conclusions .....	415
<b>Appendices</b>	
List of Technology Assessments.....	435
List of Supplemental Information.....	437
Office of the Under Secretary for Science and Energy Executive Steering Committee and Co-Champions .....	439
Authors, Contributors, and Reviewers.....	440
Glossary .....	453
Acronyms.....	471
List of Figures .....	479
List of Tables.....	487





## Message from the Secretary of Energy

The energy sector in the United States has been changing rapidly—dramatically increased oil and gas production and renewables deployment; decreased carbon dioxide emissions; enhanced energy-intensive manufacturing and introduction of technology enablers for next generation manufacturing; expansion of electric vehicles, smart grid, and distributed generation deployment; increased risk to energy infrastructure from extreme weather and sea level rise, regional water stresses, cybersecurity and other factors. Most of these developments have been materially advanced and risks attenuated by Department of Energy (DOE) research, development, demonstration, and deployment (RDD&D) programs over several decades. All are being addressed today in ways that will advance the goals of economic clean energy production, delivery and end use, with reliability and resilience.

This second Quadrennial Technology Review (QTR) explores the current state of technologies in key energy sectors and the R&D opportunities present in the mid-term. It is intended to frame a blueprint for DOE energy technology development and for the enabling science for future technology breakthroughs.

DOE has many tools to advance this agenda across the RDD&D innovation chain, among them: Energy Frontier Research Centers addressing energy-related scientific grand challenges; early stage technology development through ARPA-E and Innovation Hubs; applied energy programs (Energy Efficiency and Renewable Energy; Fossil Energy; Nuclear Energy; Office of Electricity Delivery and Energy Reliability) that span RDD&D; the Loan Program Office that supports initial commercial deployment of advanced clean energy technologies. The QTR informs all of these programs—and others—with technology assessments in electricity, buildings, advanced manufacturing, fuels, and transportation and vehicles, as well as addressing key enabling capabilities such as high-performance computing and fundamental understanding of materials. The QTR also aligns with the Department's increased focus on crosscutting R&D, such as grid modernization, subsurface science and engineering, and the energy-water nexus. A primary goal is continuing cost reduction of clean energy technology to spur the pace of deployment even more.

Progress will require continuing partnerships with innovators across the nation. The Department's network of seventeen national laboratories is obviously critical both for their work on energy science and technology and for providing unmatched research capabilities for the broader research community. Partnerships with university scientists and engineers, researchers at both established and entrepreneurial companies, federal and state agencies, and others are also essential.

Despite the energy transformation that we have seen and have been part of during the Obama Administration, we face many ongoing energy challenges—mitigating the risks of climate change through clean energy and greatly reduced greenhouse gas emissions, modernizing our energy infrastructure with resilience against the



full risk spectrum, enhancing energy security for the United States and our friends and allies. We are convinced that energy science and technology hold the key to meeting these challenges through technology, business model, and policy innovation. As such, the QTR, together with the ongoing Quadrennial Energy Review, will do much to inform DOE's efforts and contributions for years to come. We hope it will be similarly useful to the energy community at large.

**Ernest J. Moniz**  
*Secretary of Energy*



## Message from the Deputy Under Secretary for Science and Energy

QTR 2015 describes the current energy landscape, the potential for improvement in systems and technologies, and a wide-ranging set of related RDD&D opportunities. Energy technologies are assessed with respect to their potential security implications, economic and environmental impact, and engineering feasibility (costs, benefits, and theoretical limits), and technological maturity. This forward-looking assessment of energy science and technology topics will inform the RDD&D portfolio of the nation's energy enterprise.

The world of energy-related research is rich with opportunities to help create a secure, resilient, economically efficient, and environmentally responsible set of energy systems. Our analysis demonstrates that innovation at the systems level offers real potential for revolutionary changes to the ways we deliver and use energy. Those systems will rely on more efficient energy conversion technologies, and on plentiful, domestic and earth-abundant resources and an enhanced ability to design and operate them as they grow in scale and complexity. The QTR examines a diversified portfolio of energy research that will enable continued leadership by the United States in our quest to provide the clean energy services essential to modern societies.

Each of the six sectors of our energy system described in this report (grid, power, buildings, manufacturing, fuels and transportation) includes ample opportunity to advance technology at the component, device, and system levels. Just as importantly, the QTR identifies crosscutting technologies and disciplines that impact multiple sectors. These include a confluence of computational and empirical capabilities that is ushering in a new era of "systems by design" in materials, chemistry, biology, and engineered systems throughout the economy. Nowhere is this more true than in the domain of energy, where our expanding knowledge of the physical world is intrinsically linked to the development of technologies and systems at multiple scales.

QTR 2015 represents a monumental effort to combine information from across a wide spectrum of systems and technologies into a single volume. And that effort has resulted in an important set of insights. The analysis contained in these pages supports the technology component of a much broader national strategy to evolve our energy system, improving its security, resilience, economic impacts, and environmental responsibility along the way.

The analysis compiled hundreds of recent studies and reports that describe energy science, technology, and systems. Stakeholders across the energy enterprise are represented. The results of hundreds of workshops, most held in the few years prior to this document's publication, and many of which were highly focused on a specific technology, are incorporated. Additionally, nearly 200 representatives of energy industries, universities, and national labs participated in workshops held specifically to gather input for the QTR and to review its contents. Furthermore, nearly 500 energy experts provided written reviews of the QTR and its supporting technology assessments.



This QTR is intended to inform and inspire the community of stakeholders in the nation's energy system with a broad awareness of the full set of opportunities and a unity of thinking regarding strategies for advancement. For industry, the sum of the RDD&D pathways discussed herein will become opportunities to act in support of the nation's strategic energy objectives. For students, this review is an encyclopedia of potential career paths. And for energy experts in all professions, this is a reference document which supports a wide variety of activities and publications in pursuit of a secure, competitive, and clean energy system.

It is incumbent upon all of us who work on energy matters to take full advantage of this analysis of RDD&D opportunities as we work toward the energy systems of the decades to come. The scale of our energy challenges should not be underestimated, but this report gives us confidence that we can meet those challenges based on a fully enriched, diversified portfolio of RDD&D supported by government, industry, national laboratories, and universities.

**Michael Knotek**

*Deputy Under Secretary for Science and Energy*





## Acknowledgment from the Under Secretary for Science and Energy

Secretary Moniz challenged us to do a comprehensive update to the 2011 QTR. The resulting QTR 2015 is the product of a dedicated and very hard-working team of individuals drawn from across DOE and the national labs, with additional input and review by hundreds of stakeholders across the energy landscape. This assessment is unrivaled in depth and breadth of its analysis of the energy technologies of today and the possibilities for those of the future.

The team that created QTR 2015 was assembled and ably led by Michael Knotek, Deputy Under Secretary for Science and Energy. His vision of what the report could be was the basis for what is here. Sam Baldwin used his encyclopedic knowledge of energy to lead the detailed effort. He worked tirelessly to shepherd a far-flung flock of contributors, to organize and write about myriad energy topics, and to weave them together into this overview report, accompanied by fifty in-depth technology assessments that describe the full effort. The process of assembling and reviewing the report was guided by an Executive Steering Committee that included Steve Binkley, Steve Chalk, David Conrad, Patricia Dehmer\*, Julio Friedmann\*, Doug Hollett\*, Christopher (Chris) Johns, John E. Kelly\*, Henry (Hank) Kenchington\*, Harriet Kung, Robert (Bob) Marlay, David Mohler, Darren Mollot, David S. Ortiz\*, Kimberly Rasar, Pilar Thomas\*, Ellen Williams\*, and Jetta Wong. Drafting of the individual chapters was done by the following individuals: Sam Baldwin, Gilbert Bindewald, Austin Brown, Charles Chen, Kerry Cheung, Corrie Clark, Joe Cresko, Matt Crozat, Jarad Daniels, Jae Edmonds, Paul Friley, Jeff Greenblatt, Zia Haq, Kristen Honey, Marcos Huerta, Ziga Ivanic, William Joost, Akhlesh Kaushiva, Henry Kelly, Dan King, Adam Kinney, Michael Kuperberg, Alex Larzelere, Heather Liddell, Steve Lindenberg, Michael Martin, Colin McMillan, Elena Melchert, Josh Mengers, Eric Miller, James Miller, George Muntean, Pat Phelan, Charles Russomanno, Ridah Sabouni, Ann Satsangi, Andrew Schwartz, Dev Shenoy, A.J. Simon, Gurpreet Singh, Emmanuel Taylor, Jake Ward, and Bradley Williams, with review and evaluation by chapter by the ESC members identified above with “\*” and others who served as co-champions, Mark A. Johnson, Roland Risser, and Reuben Sarkar.

The analyses of energy topics and the assembly of the report drew heavily on the expertise of the seventeen DOE national labs, with particularly important contributions from Argonne National Laboratory, Brookhaven National Laboratory, Lawrence Berkeley National Laboratory, Lawrence Livermore National Laboratory, and Pacific Northwest National Laboratory. We also thank our many colleagues across DOE and the lab complex, from other agencies, and from universities and industry, who contributed a vigorous peer review.

We thank Oak Ridge Institute for Science and Education (ORISE) for their exceptional effort in producing the final version of the report. Thanks also go to the editorial review team led by Margaret Schaus with contributions from John Cabaniss, Patty Walters, Melissa Ardis, BCS Incorporated, and New West



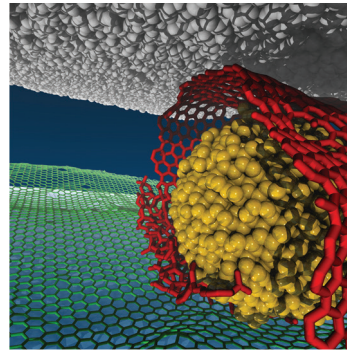
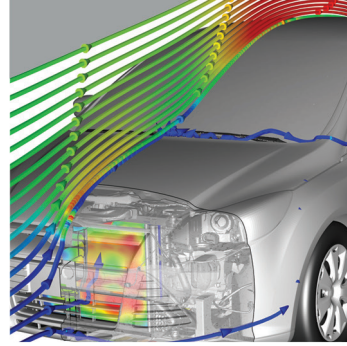
Technologies. And we thank Laurie Hakes, Noor Khalidi, and Latreese Lambirth for providing general support throughout the QTR 2015 effort.

It was my good fortune to join this team as the report was nearing completion. It is my pleasure now to recognize with gratitude all those whose hard work and thoughtful analysis is assembled here.

**Franklin Orr**

*Under Secretary for Science and Energy*







## Executive Summary

### Introduction

The United States is in the midst of an energy revolution. Over the last decade, the United States has slashed net petroleum imports, dramatically increased shale gas production, scaled up wind and solar power, and cut the growth in electricity consumption to nearly zero through widespread efficiency measures. Emerging advanced energy technologies provide a rich set of options to address our energy challenges, but their large-scale deployment requires continued improvements in cost and performance. Technology is helping to drive this revolution, enabled by years to decades of research and development (R&D) that underpin these advances in the energy system.

The energy revolution underway creates additional opportunities for technologies and systems with superior performance and reduced costs. The convergence of many energy sectors—such as the electric grid, electricity production, buildings, manufacturing, fuels, and transportation—into systems linked through information and communications technologies (ICT), advanced modeling and simulation, and controls, has the potential to revolutionize energy services throughout the economy. These advances can enable the United States to address pressing national energy challenges—security, economic vitality, and climate change.

The 2015 Quadrennial Technology Review (QTR) examines the status of the science and technology that are the foundation of our energy system, together with the research, development, demonstration, and deployment (RDD&D) opportunities to advance them. It focuses primarily on technologies with commercialization potential in the midterm and beyond. It frames various trade-offs that all energy technologies must balance across such dimensions as cost, security and reliability of supply, diversity, environmental impacts, land use, and materials use. Additionally, it provides data and analysis on RDD&D pathways to assist decision makers as they set priorities, within budget constraints, to develop more secure, affordable, and sustainable energy services. Policies and regulations are examined separately by the Quadrennial Energy Review (QER).

### National Energy System Strategic Objectives

Three enduring strategic objectives are foundational to our nation's energy system: energy security, economic competitiveness, and environmental responsibility.

**Secure and resilient:** There are four interrelated dimensions to energy security: physical, cyber, supply, and conflict-related. Physical security risks are related to damage to energy supply, storage, and delivery infrastructures, such as the electric grid, pipeline networks, and rail and marine systems. Cybersecurity vulnerabilities are related to the compromise of ICT-based controls that operate and coordinate energy supply, delivery, and end-use systems. Supply security risks are related to price shocks and international supply disruptions of energy commodities, critical materials, and/or equipment. Conflict-related security risks are associated with unrest in foreign countries linked to, or impacting, energy. Climate change increases physical security risks with sea level rise and intensification of extreme weather.

**Economically competitive:** Energy underpins every facet of the nation's economy and modern way of life. Low energy costs are beneficial to consumers and therefore the broader economy. Decades of research have gone into reducing the capital, operating, and fuel costs of conventional and advanced energy technologies. The benefits of this research are evident in the recent price declines of natural gas, domestic oil, wind turbines, photovoltaics, and efficient lighting. Progress in a broader array of advanced technologies could increase the diversity and stability of energy supplies, and spark competition to drive further price declines.

**Environmentally responsible:** Development of a clean energy system will rely on increasingly advanced technologies to minimize its environmental footprint. Over the last several decades, the United States has made significant progress in reducing pollution—atmospheric, water, land—from energy-related activities. For example, energy-related atmospheric emissions of conventional pollutants such as particulates, sulfur, and nitrogen compounds have been reduced through improved combustion strategies and “end-of-pipe”—e.g., scrubbers, catalytic converters—emissions controls. Additional emissions reductions have been achieved by improving efficiency and transitioning to cleaner fuels and low-carbon resources. These successes demonstrate what can be accomplished with RDD&D and policy. Advanced technologies can have a significant impact on the next generation of challenges, especially deep reductions in greenhouse gas (GHG) emissions to moderate the otherwise increasing damage from climate change and ocean acidification. The United States can demonstrate the viability of sustainable energy systems to the global community and provide leadership in creating vibrant economies, enhancing human progress, and assuring a sustainable biosphere.

Developing energy systems that balance trade-offs to simultaneously advance toward these objectives requires RDD&D across a diversified portfolio of technologies. It also requires understanding the multiple dimensions of each of these objectives.

## Energy System Perspective

To help identify where RDD&D can have the greatest impact, it is first necessary to understand how energy is used in the United States. A complex and vast array of systems and associated technologies extract energy resources; convert them into usable forms of energy; and deliver them to end users to provide desired services such as manufactured goods, thermal comfort, lighting, and mobility. The current state of energy supplies and end uses is described in Chapter 1.

Increasing the interconnectedness and resulting interdependency among energy sectors creates both opportunities and challenges that should be approached from an energy system perspective. Strategies for advancing technology across the entire energy system, in contrast to individual energy technologies, are necessarily broad.

First, certain technologies affect the energy system by impacting more than one energy sector. Application of an energy system view of technology can help to identify the crosscutting impacts of technologies developed for a particular application as applied to other sectors, as well as the elements of the value chain that must be in place for success. Realizing the full benefit of developing these crosscutting technologies requires the involvement of stakeholders from across the energy economy.

Second, the systems perspective can illuminate opportunities to improve performance and/or mitigate risk through sector integration. Success requires advancing the operation, planning, modeling, and simulation of technical systems integrated across sectors.

Finally, application of an energy system view can be used to develop solutions to complex energy challenges. New paradigms based on the science of large and complex systems can help enable the prediction and control of emergent properties and behaviors, including disruptions that arise from sector and technical system interconnectedness. The focus of Chapter 2 is *Energy Sectors and Systems*.

## Overarching Themes, Energy Sectors, and Crosscutting RDD&D Opportunities

By studying the whole energy system and the interdependency of the energy sectors, four overarching themes, six sets of core RDD&D opportunities (organized by energy sector), and twelve crosscutting technology areas are identified and presented.

### Overarching Themes

Four overarching themes emerged from the QTR and associated technology assessments: 1) the convergence of energy systems across sectors; 2) diversification within energy supplies and services; 3) confluence of R&D, computational tools, and analysis of complex systems; and 4) energy efficiency.

**Convergence:** Virtually all sectors of the energy system are becoming increasingly interdependent. Further, the power, grid, buildings, manufacturing, fuels, and transportation sectors of the energy system are necessarily coupled to water systems, material flows, waste products, and energy financial markets. Properly tuned and integrated energy sectors and technology systems have the potential to improve their overall operations, increase their efficiency, and enable fundamentally new concepts in the structure of the energy economy.

**Diversification:** Most energy sectors in the United States are experiencing a trend toward increased diversification. For example, electricity, hydrogen, natural gas, and biofuels are entering the transportation sector, while the power sector is shifting to greater use of natural gas and renewables. This diversification creates challenges for energy infrastructures, but it can also provide flexibility.

**Confluence:** The confluence of advances in computing power and software, theory, modeling, synthesis and characterization is rapidly ushering in a new era of “systems by design” for materials, chemicals, and biological science. This transformation from observation to control and design of complex systems has the potential to accelerate development of these systems with desired properties. This set of concepts—generalized to new classes of sensors, big data management, and computational modeling—is applicable across the spectrum of complex systems topics encountered in the energy system.

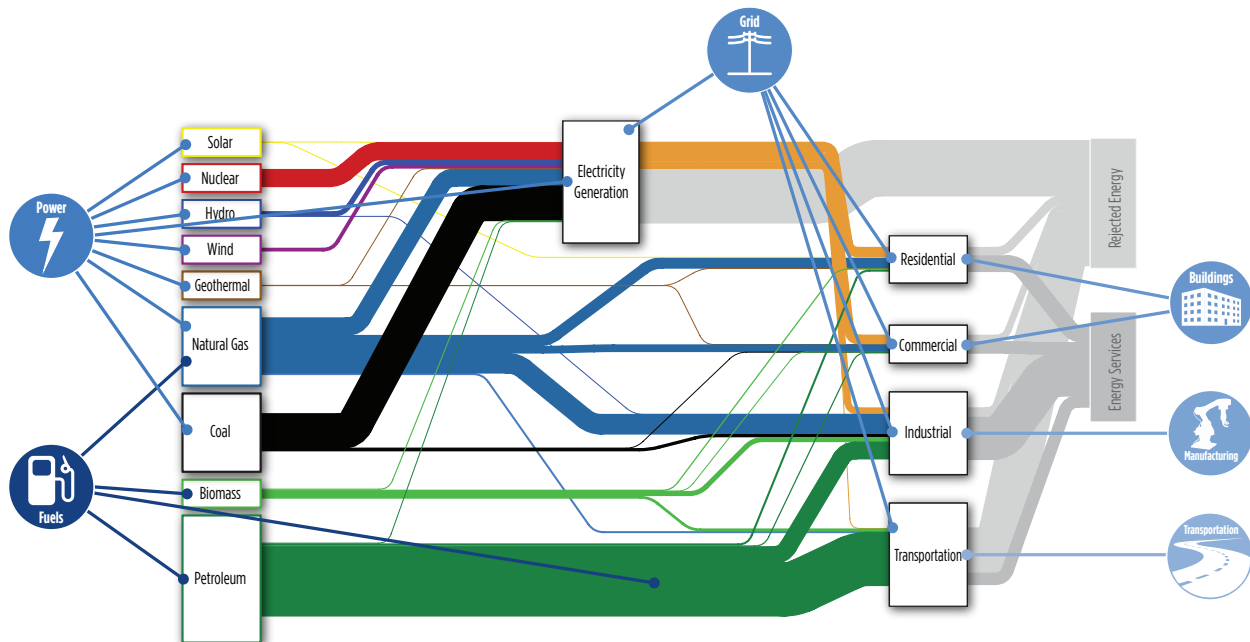
**Efficiency everywhere:** Achieving greater efficiency is a proven means to help achieve national energy security, cost, and environmental goals. As raw energy resources are transformed into services and products, losses compound along the energy value chain. Efficiency improvements in any step along the value chain can materially impact costs, consumption, and emissions. RDD&D opportunities to advance cost-effective efficiency technologies permeate all of the energy sectors and systems.

### Energy Sectors

The QTR describes the national energy system as comprising six individual sectors: 1) the electric grid, 2) electricity production (power), 3) buildings (residential and commercial), 4) manufacturing (the majority of the larger industrial sector), 5) fuels (with an emphasis on fuels for transportation), and 6) transportation. Each of these sectors comprises numerous technical systems, sub-systems, and component technologies. The QTR dedicates a chapter to each of these six sectors, exploring its related technologies, challenges, and RDD&D opportunities.

**Figure ES.1** Sankey Diagram of the U.S. Energy System Depicting Major Areas of Coverage by the Technical QTR Chapters 3–8

**Estimated U.S. Energy Use in 2014: ~98.3 Quads**



**Electric grid sector:** The U.S. electric power sector is the centerpiece of the nation’s energy economy. However, the design and operation of today’s grid is being challenged to meet the evolving security, cost, and environmental needs of a low-carbon, digital economy. Shifts are occurring on the supply side (e.g., increased adoption of renewable resources) and demand side (e.g., growing use of demand side management). Accompanying these changes is the growing adoption of digital communications and control systems (i.e., smart grid technologies) to improve performance and engage consumers. Additionally, grid operation is moving from controlling systems with a handful of control points at central stations to ones with potentially millions of highly interactive distributed control points. In short, the power grid is confronted with new requirements as it attempts to perform in ways for which it was not designed. Meanwhile, the nation’s reliance on a dependable, efficient, and resilient power grid is rising. The focus of Chapter 3 is *Enabling Modernization of the Electric Power System*.

**Electricity production sector:** The current portfolio of electricity production includes a combination of reliable but aging base-load generation, evolving renewable resources, new natural gas plants, and new and pending nuclear and clean coal facilities. As the industry evolves to meet growing electrification and GHG reduction goals, challenges arise in optimizing the system, minimizing risks, and maintaining reasonable cost. Future developments will likely include a mix of three broad categories: 1) fossil-based generation with carbon capture and storage (CCS), 2) nuclear energy, and 3) renewables, such as solar and wind. Technologies that enable higher efficiencies and effective pollution control are an essential complement to this evolving generation mix. Similarly, crosscutting concepts—such as supercritical carbon dioxide Brayton cycles—could, if broadly applied, impact efficiency, emissions, and water consumption across fossil, nuclear, geothermal, and solar thermal plants. While supporting aggressive emission reductions, the traditional market drivers such as reliability, safety, and low cost must be maintained and enhanced. The focus of Chapter 4 is *Advancing Clean Electric Power Technologies*.



**Buildings sector:** Considerable potential exists to reduce building energy use. The residential and commercial buildings sector accounts for about 74% of electricity use and 40% of all U.S. primary energy use. Many building technologies are available today that would significantly reduce energy use relative to the existing building stock. Yet, the best available and most cost effective ones are only beginning to be widely adopted in the marketplace. It has become increasingly apparent that technology developments in the buildings sector have the potential to simultaneously accelerate cost reductions, service improvements, and efficiency gains. Advanced heating/cooling and lighting are current R&D priorities, as they represent the greatest end-use energy-saving opportunities. Much progress is being made in areas such as light-emitting diode (LED) lighting, appliances, and non-vapor compression heating, ventilation, and air conditioning (HVAC). Miscellaneous electric loads and an eclectic mix of technologies (e.g., grills, spa and pool pumps, laundry, and elevators) are expected to be an increasing share of the remaining load as other end uses become significantly more efficient. The focus of Chapter 5 is *Increasing Efficiency of Building Systems and Technologies*.

**Manufacturing sector:** Manufacturing consumes twenty-four quads of primary energy annually in the United States—about 79% of total industrial energy use. However, this sector’s energy impacts are much broader, as manufactured goods affect the production, delivery, and use of energy across the economy. Improved manufacturing technologies can drive economy-wide energy impacts, including energy efficiency in the manufacturing sector; new types of manufactured products; and sustainability of U.S. industry supply chains and their life-cycle impacts. The focus of Chapter 6 is *Innovating Clean Energy Technologies in Advanced Manufacturing*.

**Fuels sector:** Fuels supply 99.8% of the energy currently used in the transportation sector and 70% of the energy used to generate electricity in the United States. The economy will need to balance the various strengths and shortcomings of a broad mix of fuels during the transition from a high-carbon to a low-carbon economy. This fuel mix includes the following:

- **Fossil fuels:** Chemical fuels, primarily derived from fossil energy resources, supply about 83% of total U.S. primary energy use.
- **Bioenergy fuels:** With technology improvement and a mature market, available bioenergy could provide more than fifty billion gallons of fuels per year, equivalent to about 25% of current transportation fuel demand.
- **Hydrogen fuels:** Technologies for producing hydrogen from large natural gas reforming plants are mature, but the costs of converting the end-to-end fuels infrastructure, including delivery, to accommodate hydrogen are high. While the near-term deployment challenge is to reduce the cost of infrastructure for fueling vehicles, in the longer term the major challenge is to reduce the cost of hydrogen production from regionally optimized renewable and low-carbon resources.

With recent growth in domestic shale gas and tight oil production, near-term concerns over fuel supply and energy security are easing. However, the economic and environmental impacts of heavy reliance on fossil fuels make their further cleanup or transition to clean alternatives imperative. The trade-offs between conventional (oil and gas) and alternative fuels (primarily biofuels and hydrogen) or substitution with electricity—i.e., cost, performance, infrastructure, security, and environmental impacts—are complex. Optimizing the benefit of fuel diversification is challenged by the varying time frames for development and deployment of fuels, production and distribution infrastructures, and end-use devices such as vehicles. The focus of Chapter 7 is *Advancing Systems and Technologies to Produce Cleaner Fuels*.

**Transportation sector:** Transportation provides essential passenger, freight, and other mobility services to individuals and the economy. It is the primary user of petroleum in the United States and a major emitter of air pollutants and GHGs. Currently, light- and heavy-duty vehicles account for approximately three-quarters of transportation energy use and emissions. Other modes in the transportation system include rail, marine,

aircraft, and pipelines, the proportional emissions from which are likely to grow in importance as the efficiency of on-road transportation technologies improves. To greatly reduce GHG emissions, a larger share of vehicles must efficiently use fuels or power with drastically reduced life-cycle carbon emissions. The technology portfolio benefits from a set of complementary RDD&D pathways, including advanced combustion, light-weighting, battery storage, electric drivetrain, fuel cell systems, and recharging and refueling infrastructure. Addressing the transportation sector as a holistic system that encompasses more than just vehicle technologies is another important emerging research opportunity. The focus of Chapter 8 is *Advancing Clean Transportation and Vehicle Systems and Technologies*.

## Crosscutting RDD&D Opportunities

Inevitably, many technology themes were identified that cut across the six sectors. As a result, they should be integrated in ways that bridge strict sectoral boundaries. In a simplified view, the crosscutting topics can be grouped into two major categories: “technical topics” and “enabling tools.”

The “technical topics” include the following:

- **Grid modernization:** Advanced grid technologies are needed to improve the agility and flexibility of the system to better integrate the changing characteristics of devices and technology systems on both the supply and demand sides.
- **Systems integration:** Appropriate application of systems integration requires understanding, control, and optimization across multiple sectors, time frames, and spatial scales. An integrated systems approach can address complexity and enable more efficient deployment of advanced energy technologies.
- **Cybersecurity:** Opportunities to improve cybersecurity are being actively pursued for the energy sector (i.e., electric, oil, and gas), and also exist in industrial automation systems and information technology-enabled innovations across the fuels, power generation, buildings, manufacturing, and intelligent vehicle spaces.
- **Energy-water:** Science and technology advancements at the intersection of energy and water can reduce energy use and increase water availability for human consumption, other non-energy uses, and natural systems.
- **Subsurface:** Understanding and controlling fractures, fluid flow, and complex chemistry in subsurface rock formations on timescales of microseconds to millennia are important for oil and gas production, geothermal energy, CCS, and nuclear waste disposal.
- **Materials:** Across all energy sectors, advancements in materials could dramatically accelerate and reduce the cost of developing new energy technologies. Examples include development of materials for extreme working conditions, advanced processing of them, and their rapid qualification.
- **Fuel-engine co-optimization:** With bio-derived and/or other synthetic fuels there is an opportunity to optimize the end-to-end fuel-vehicle system for improved efficiency and reduced environmental impacts.
- **Energy storage:** Fundamental research on efficient, durable storage could enable transformational change across multiple sectors, including transportation, and the electricity system.

The “enabling tools” include the following:

- **Computational modeling and simulation:** Advances in high performance computation have enabled simulation of increasingly complex physical phenomena. High-fidelity simulations, in turn, inform models that improve and accelerate the RDD&D phases of the energy innovation cycle.
- **Data and analysis:** Opportunities to apply advanced analytics transect the entire clean energy economy. The emerging science of extracting actionable information from large data sets is both an opportunity to accelerate RDD&D and a research need.

- **Analysis of complex systems:** Increasing complexity resulting from the convergence of the sectors of the energy system introduces a need for foundational, conceptual research on integrated, networked, and complex systems.
- **Characterization and control of matter at multiscales:** Extraordinary advances in characterization and modeling of materials and chemistry have paved the way for manipulating and synthesizing materials at the atomic-, nano-, and mesoscale to create new tailored functionalities. The research spans a range of dimensions from the atom, to biological cells, to macroscopic structures, with applications across many scientific and engineering disciplines.

The crosscutting RDD&D opportunities listed here offer the potential to dramatically improve the performance and posture of all energy resources and end uses. They represent a condensed set of concepts—linked by an overarching goal to understand, predict, and control complex energy systems—that appear in more than one of the technology areas of this report (see Table 2.1).

## Enabling Capabilities for Science and Energy

Investment in basic science research is expanding our understanding of how structure leads to function—from the atomic- and nano-scale to the meso-scale and beyond—and is enabling a transformation from observation to control and design of new systems, with properties tailored to meet the requirements of the next generation of energy technologies. The challenges in energy science and technology development increasingly necessitate interdisciplinary collaboration. The multidisciplinary and multi-institutional research centers supported by DOE and others have the potential to accelerate development of new and transformative energy technologies by more effectively integrating basic science and applied research. At the core of this new paradigm is a diverse suite of complex experimental and computational tools that enable researchers to probe and manipulate matter at unprecedented resolution. The planning for and development of these tools are rooted in basic science, but they are critically important for technology development, enabling discoveries that can lead to broad implementation. These tools are available through a user facility access model that provides open access, regardless of institutional affiliation, for nonproprietary research based on merit review of submitted proposals. This is a synergistic model: thousands of scientists and engineers leverage the capabilities and staff expertise for their research, while the facilities leverage user expertise toward maintenance, development, and application of the tools in support of the broader community of users. The focus of Chapter 9 is *Enabling Capabilities for Science and Energy*.

## Concepts in Integrated Analysis

A goal of technology development programs, whether in the private sector or in government institutions, is to maximize the positive impact of RDD&D portfolio investments in energy technologies. The many technologies described in this QTR illustrate the potential impacts that further RDD&D could have to create a secure, competitive, and clean energy system. Weighting of these impacts, as well as the metrics from which they are built (e.g., cost, performance, land use, water quality, GHG emissions, etc.), will necessarily vary with the perspective of the observer. Research institutions must consider multiple impact metrics that address their overarching goals from a business or public perspective. To this end, portfolio analysis is widely employed, but at varying levels of thoroughness, analytic rigor, and transparency. Many tools for technology planning and projection, analysis, metrics calculation, and impact evaluation exist already, but are not necessarily fully developed or packaged in a way that can be readily used for evaluating energy portfolios. This QTR explores processes to shape an energy portfolio and estimate the potential impacts, articulates the current state of integrated technology assessment, gives examples of sector-specific applications of metrics and tools for technology analysis in use in various organizational contexts (i.e., corporate, nonprofit, academic, and government), and identifies gaps that require further development of technical assessment capabilities. The focus of Chapter 10 is *Concepts in Integrated Analysis*.



## Conclusion

The world of energy-related research is rich with opportunities to help create a secure, resilient, economically efficient, and environmentally responsible set of energy systems. Those systems will rely on more efficient energy conversion technologies and will benefit from improved understanding of complex, interdependent systems that provide electricity, transportation, water, and materials for manufacturing. Underlying the advances in those areas will be the many technologies and capabilities described in this report, as well as fundamental scientific research and advanced scientific computing for complex systems. The technology development community is beginning to take advantage of the rapidly emerging set of tools for creating new generations of materials, devices, and systems for energy applications; however, much more can be done. A goal is to put these new tools in their hands to drive a well-diversified portfolio of energy research that will enable leadership by the United States to provide the energy services essential to modern societies.





*Energy  
is the  
Engine  
of the  
U.S.  
Economy*



# 1

## Energy Challenges

### 1.1 Introduction

The United States' energy system, vast in size and increasingly complex, is the engine of the economy. The national energy enterprise has served us well, driving unprecedented economic growth and prosperity and supporting our national security. The U.S. energy system is entering a period of unprecedented change; new technologies, new requirements, and new vulnerabilities are transforming the system. The challenge is to transition to energy systems and technologies that simultaneously address the nation's most fundamental needs—energy security, economic competitiveness, and environmental responsibility—while providing better energy services. Emerging advanced energy technologies can do much to address these challenges, but further improvements in cost and performance are important.<sup>1</sup> Carefully targeted research, development, demonstration, and deployment (RDD&D) are essential to achieving these improvements and enabling us to meet our nation's energy objectives.

This report, the 2015 Quadrennial Technology Review (QTR 2015), examines science and technology RDD&D opportunities across the entire U.S. energy system. It focuses primarily on technologies with commercialization potential in the mid-term and beyond. It frames various tradeoffs that all energy technologies must balance, across such dimensions as diversity and security of supply, cost, environmental impacts, reliability, land use, and materials use. Finally, it provides data and analysis on RDD&D pathways to assist decision makers as they set priorities, subject to budget constraints, to develop more secure, affordable, and sustainable energy services.

The energy science and technology RDD&D opportunities described in this report, if successfully conducted and commercialized at scale, would significantly impact the energy security, economic, and environmental challenges that face the United States and the world.

### 1.2 The U.S. Energy System

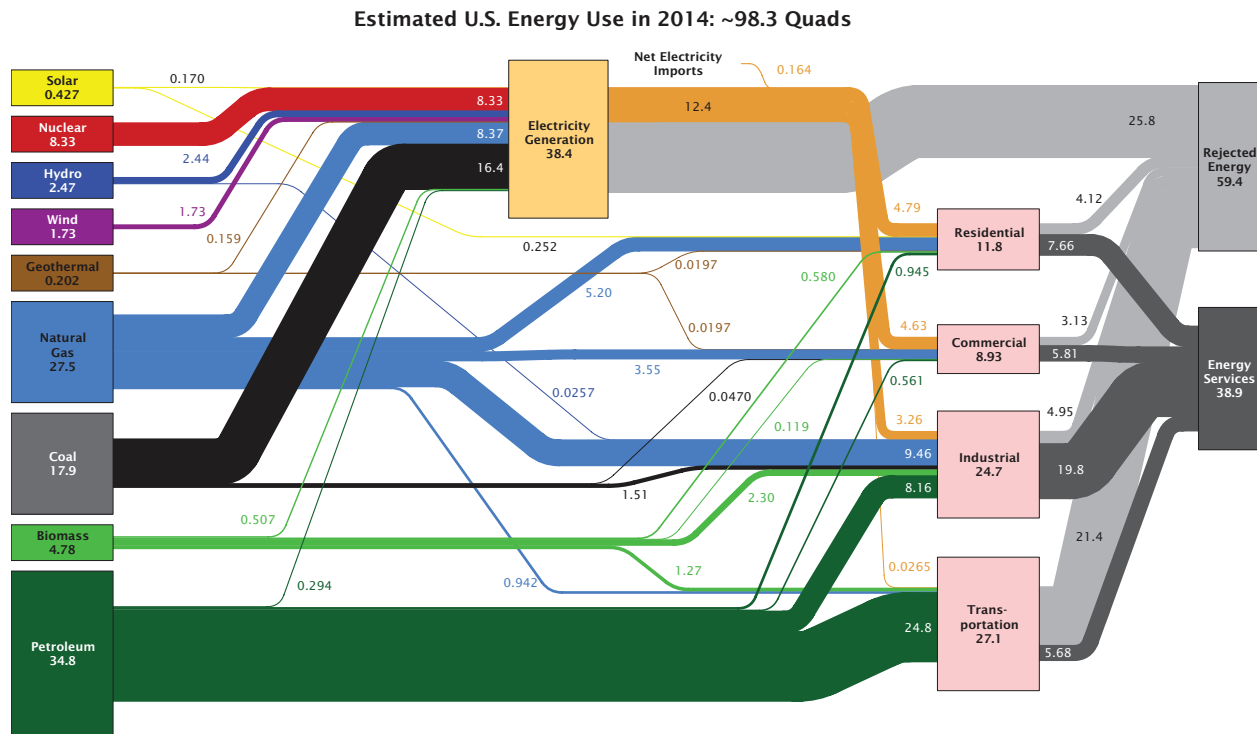
A vast and complex array of systems and associated technologies extract energy resources, convert them into usable forms of energy, and deliver them to end users to provide desired services such as manufactured goods, thermal comfort, lighting, and mobility.

The overall flow of energy through the U.S. energy system is illustrated in Figure 1.1.<sup>2</sup> It illustrates the initial energy resources, their conversions into fuels and electricity, and their use in the buildings, industry, and transportation sectors to provide the energy services that support our economy and our way of life. It also illustrates energy losses (rejected energy) that result from the fact that energy conversion processes are never 100% efficient.



**Figure 1.1** The Sankey Diagram depicts the flow of energy resources (left) to end-use sectors (right).

Credit: Lawrence Livermore National Laboratory



### 1.2.1 U.S. Energy Supply and Use

Figures 1.2 and 1.3 provide more detail on the energy inputs and applications within the buildings, industrial, and transportation sectors.

Fossil fuels supply about 82% of the primary energy use in the United States. The challenges and opportunities associated with fossil fuels are explored in Chapters 4 (*Advancing Clean Electric Power Technologies*) and 7 (*Advancing Systems and Technologies to Produce Cleaner Fuels*), as well as elsewhere throughout the report.

There are many pathways to produce electricity, with the generation mix currently dominated by coal, natural gas, and nuclear resources. Options for improving the performance of the electricity grid are described in Chapter 3 (*Enabling Modernization of the Electric Power System*), while options for developing cleaner, more competitive, and more secure supplies are described in Chapter 4.

The buildings sector is the largest consumer of electricity, and electricity supplies the majority of primary energy that is consumed in buildings. Buildings sector energy technology opportunities, discussed in Chapter 5 (*Increasing Efficiency of Building Systems and Technologies*), are thus heavily weighted toward technologies powered by electricity.

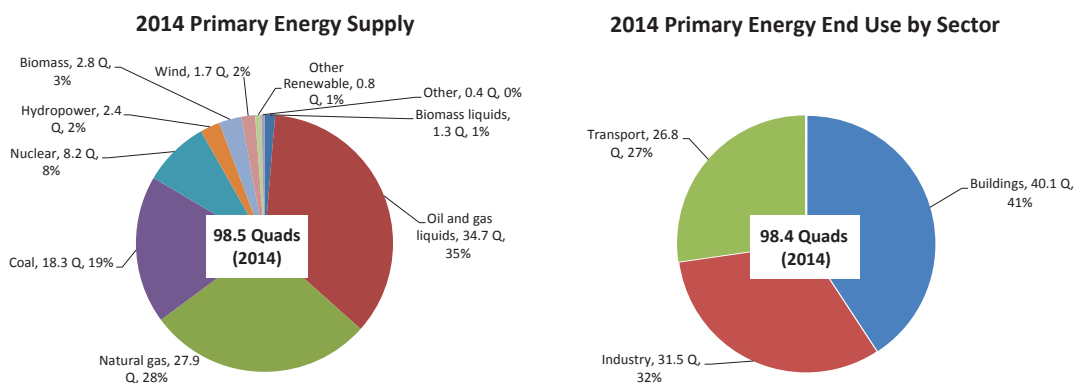
The industrial sector is the most diverse consumer of energy, and also has the most diverse set of energy applications. This sector includes manufacturing (the focus here) as well as agriculture, construction, and mining. Opportunities to address energy challenges in the manufacturing sector, in particular, are likewise diverse, and are discussed in Chapter 6 (*Innovating Clean Energy Technologies in Advanced Manufacturing*).



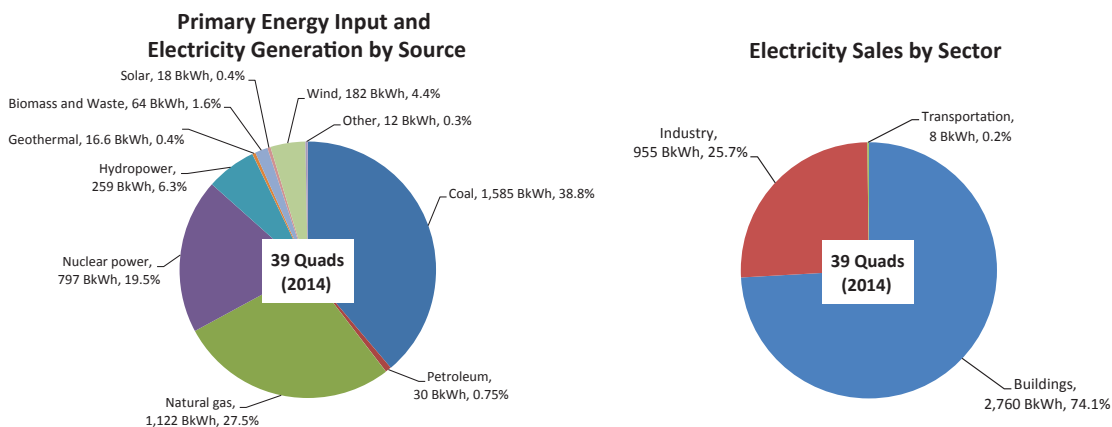
The energy inputs for the transportation sector are almost completely dominated by petroleum-based fuels. Energy use in this sector is dominated by light-duty vehicles. Opportunities to displace and/or improve the use of petroleum fuels in light-duty vehicles are considered first, with other important opportunities discussed in somewhat less detail. Chapters 7 and 8 (*Advancing Clean Transportation and Vehicle Systems and Technologies*) cover the fuels and transportation space.

## U.S. Energy: Supplies and Sectoral Uses<sup>3</sup>

**Figure 1.2a** U.S. Primary Energy (a) Supply and (b) Consumption in the End-Use Sectors in quads and as a percent of total U.S. primary energy, respectively. Note that fossil fuels supply about 82% of U.S. primary energy consumption.



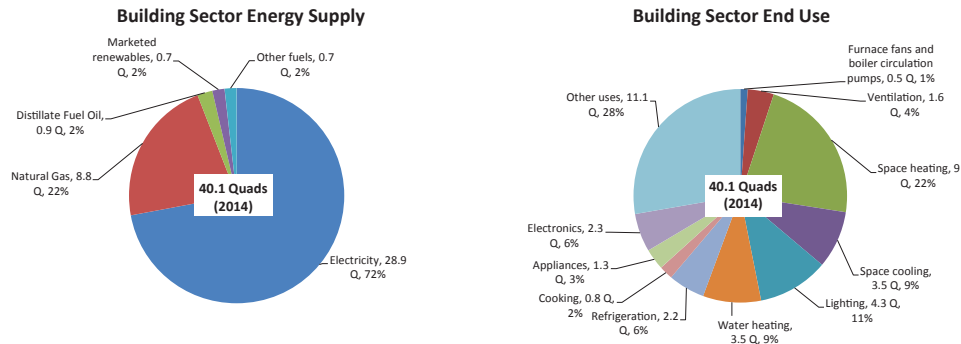
**Figure 1.2b** U.S. Electric Power by (a) Total Primary Input (quads) and Electricity Generation by Source (kWh and %); and (b) Electricity End Use by Sector in kWh and as a percentage of total U.S. electricity generation. Note that coal is the largest source of energy and the buildings sector accounts for 74% of electricity consumption.



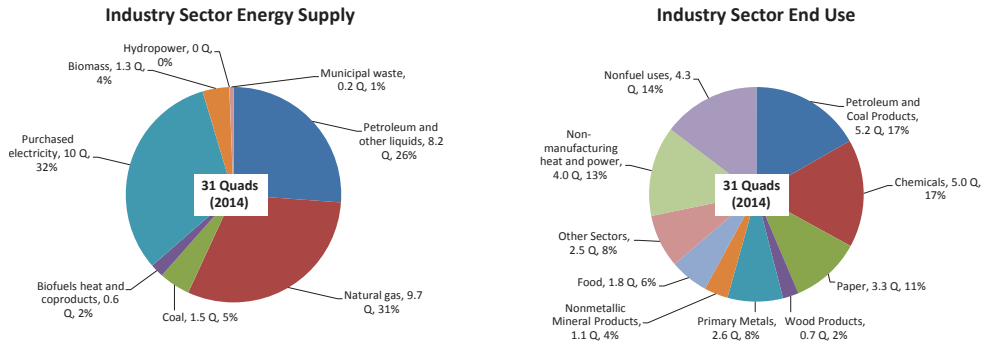


## Use Sectors: Supplies and End Uses<sup>4,5,6,7</sup>

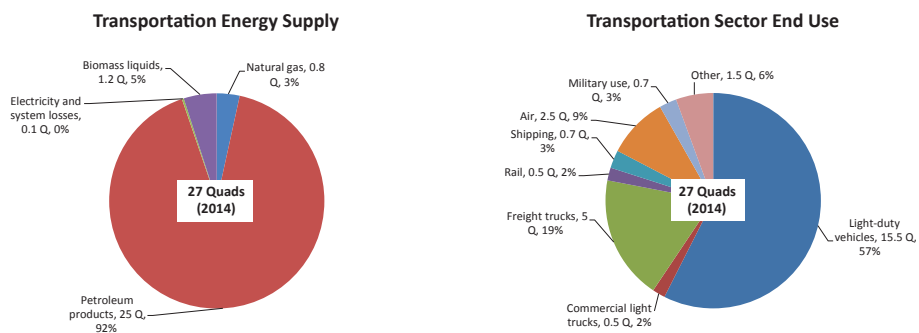
**Figure 1.3a** Building Sector Energy by (a) Primary Energy Supply and (b) Energy End Uses in quads and as a percent of total U.S. building energy supply and use. Note that the building sector directly uses large amounts of natural gas.



**Figure 1.3b** Industry Sector Energy by (a) Primary Energy Supply and (b) Energy End Uses in quads and as a percent of total U.S. industry energy supply and use. Note that natural gas and petroleum dominate energy use in the industry sector. Much of the energy is used for energy-intensive commodity materials processing.



**Figure 1.3c** Transportation Sector Energy by (a) Primary Energy Supply and (b) Energy End Uses in quads and as a percent of total U.S. transportation energy supply and use. As can be seen, the transportation sector is almost entirely dependent on petroleum.



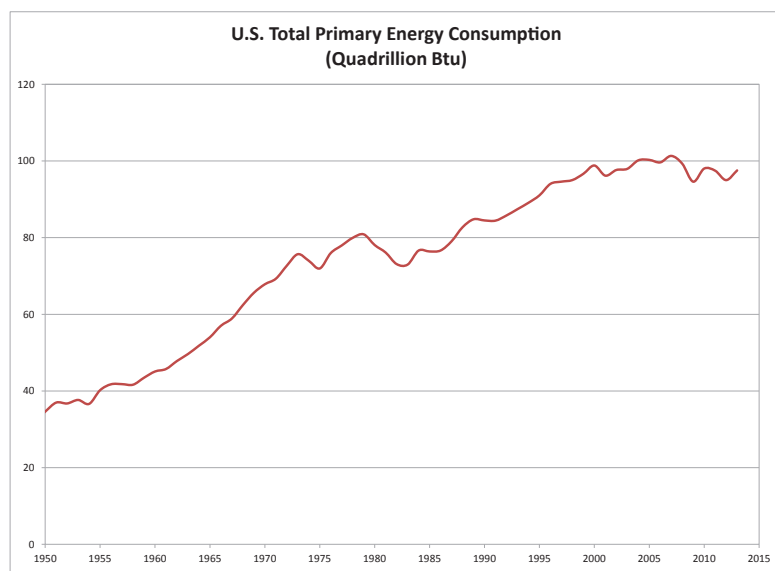
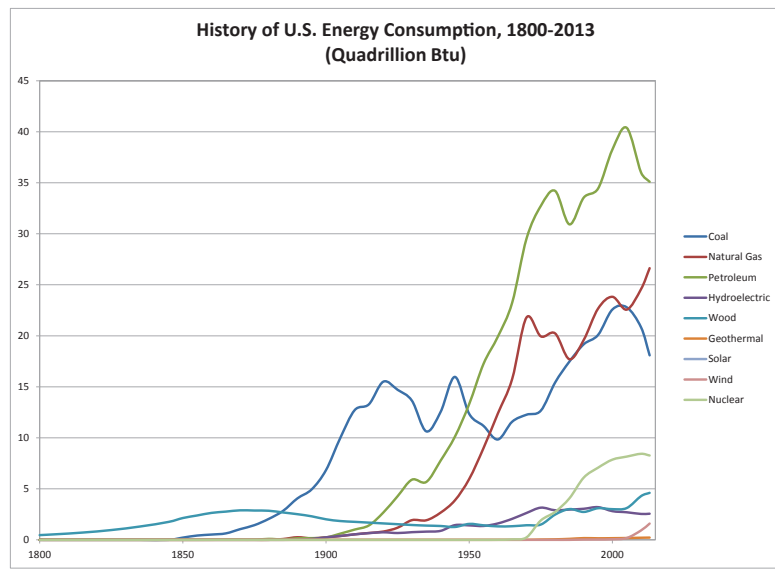
### 1.2.2 Changes in U.S. Energy Supply and Demand

Over the past 200 years, the predominant source of energy supply in the United States has changed several times, with typical transition times of fifty to one hundred years. Figure 1.4 illustrates these shifts from wood to coal to oil and now toward natural gas and renewables. Much of this report is aimed at accelerating beneficial shifts in shorter time frames in the future.

Over the last four years since QTR 2011 was published, dramatic changes in U.S. energy supply and demand have taken place (see textbox: *Major Changes in the Energy Landscape*). The recent “shale revolution” in oil and gas has garnered the most attention of late, but transformations are occurring in a number of energy sectors (Table 1.1). Over the same period, U.S. energy consumption has increased by only about 1%, even as the population grew 3.1% and the economy grew 8.2%, reflecting extraordinary gains in energy productivity.

As rapid as the changes have been to the U.S. energy system over the past four years, future growth in the global energy system is anticipated to dwarf these changes. The developing world requires large increases in the services that energy provides to continue its economic development. Bringing modern energy services to the more than five billion people with little or no service today is a monumental challenge. For the foreseeable future, the bulk of new market growth for energy technologies will be in the emerging markets of Asia, Latin America, Africa, and other areas outside the Organisation for Economic Cooperation and Development (OECD). The U.S. Energy Information Administration (EIA) projects that total annual primary energy use by OECD countries will increase from today’s 240 quads to about 280 quads in 2040, while primary energy use by the rest of the world will increase from

**Figure 1.4** U.S. Primary Energy Use over time in Quads: (a) from 1800 to the present by source,<sup>8</sup> and (b) total primary energy use from 1950 to the present.<sup>9</sup> Note how the largest primary energy resource has changed several times over history.





## Major Changes in the Energy Landscape

The period from 2010 through 2014 was one of dramatic change in the U.S. energy landscape. These four years have seen the culmination of decades-long RDD&D investments beginning to transform the market. This transformation is occurring across supply and distribution of fuels and electricity, and across end uses—buildings, industry, and transportation. The U.S. energy enterprise is engaging the challenges of energy security, economic competitiveness, climate change, and other environmental issues, driven by a variety of factors ranging across technology readiness, market demand, and public policy.

### Increased domestic oil and gas production

Over the past decade, adoption of technology to recover oil and gas from “unconventional” resources, such as shale and tight geological formations, has significantly increased proved reserves and production of oil and gas. From the beginning of 2010 through the beginning of 2014, proved oil and lease condensate reserves in the United States increased by more than 60%, from 22 to 36 billion barrels.<sup>24</sup> Similarly, oil production increased by 40%, from 11 to 16 quadrillion British thermal units (quads) per year.<sup>25</sup> Over the same period, proved reserves of wet natural gas increased by 25%, from 280 to 350 trillion cubic feet,<sup>26</sup> while annual production increased by 18%, from 21 to 25 quads.<sup>27</sup> Beyond increased economic activity in the energy sector, the benefits of improved oil and gas accessibility in the United States include vastly reduced oil imports, an improved investment outlook for energy-intensive industries, and lower direct greenhouse gas (GHG) emissions due to gas replacing coal in the electricity generation sector.

### Decreasing growth of gasoline consumption

After twenty-five years of virtually uninterrupted growth, gasoline consumption began to decline in 2008 and has been relatively flat since 2011. Multiple factors have driven this trend as described below:

- Per-capita vehicle miles traveled peaked in 2004<sup>28</sup> and have been declining ever since.
- Shifting consumer preferences toward smaller and more fuel-efficient vehicles, combined with higher fuel economy standards,<sup>29,30</sup> have increased new light-duty fuel economy to a record high in 2014.<sup>31</sup>
- Blending of ethanol into the gasoline supply, which ramped up in 2005, has displaced approximately 10% of the petroleum content of gasoline.<sup>32</sup> Continued growth in ethanol use will depend on either growth of gasoline consumption or market uptake of higher-level blends such as E15 and E85.

Between the decrease in demand for fuel and the increase in domestic supply, net imports of oil and petroleum products have decreased by 35% since 2011 and 50% since their peak in 2005.<sup>33</sup> Global oil prices also fell by almost 50% during the latter half of 2014,<sup>34</sup> driven by a combination of increased supply in the United States, reduced economic growth forecasts in the developing world, and a dynamic geopolitical environment.

### A newly dynamic nuclear power landscape

Since 2012, five nuclear reactors have been retired in California, Wisconsin, Florida, and Vermont. In 2019, one additional reactor is scheduled for retirement in New Jersey. During this same time, construction continued on a reactor in Tennessee and started on four new Generation III+ reactors in Georgia and South Carolina.<sup>35</sup> These new reactors have advanced passive safety features that are predicted to make them the safest in the fleet.

### Increased deployment of wind and solar energy

Between 2011 and 2015, the installed capacity of wind energy increased by 65%, from 40 gigawatts (GW) to 66 GW.<sup>36</sup> During that same period, the capacity of installed solar photovoltaic generation increased from about two GW to

18 GW.<sup>37</sup> Today, enough wind energy has been deployed that it is a significant contributor to the nation's electricity supply (more than 4%).<sup>38</sup>

### **Increased deployment of smart grid technologies**

More than 1,300 digitally connected phasor measurement units and millions of smart meters were connected to the electrical grid between 2010 and 2014.<sup>39</sup> These devices and advanced communication networks are allowing unprecedented visibility of the operation of what many call “the largest machine on earth.”<sup>40</sup> The volume, variety, and speed of the newly available data streams are at the early stages of improving grid management.

### **Slowing growth of electricity consumption**

Growth in U.S. electricity demand is at its lowest level in decades.<sup>41</sup> In the residential and commercial sectors, which now account for approximately 74% of electricity consumption, adoption of significantly more energy efficient devices has played a major role in this decline. Policies that promote energy efficiency are partly responsible for this adoption, while technology shifts to more appealing and effective devices that are more energy efficient (e.g., mobile computing, flat panel monitors) are also a factor.

### **Increasing opportunities for U.S. manufacturing**

The availability of lower-cost natural gas and natural gas liquids has created an advantage for U.S. manufacturers that use these resources for heat, power, or as chemical feedstocks. This has contributed to some expansions and additions to the U.S. petrochemical manufacturing sector.<sup>42</sup> The industrial sector as a whole can similarly benefit from low-cost natural gas.

### **Growing market for electric vehicles**

Over the past four years, electric vehicles have successfully carved out a niche market. Plug-in electric vehicle (PEV) sales went from virtually zero in 2010 to approximately 100,000 per year by 2014.<sup>43</sup> These sales include premium vehicles, such as Tesla Model S, and mass-market vehicles, such as the Nissan Leaf and Chevrolet Volt. At current levels of market share, these vehicles do not materially change the overall energy demand or emissions profile of our national energy economy. However, because adoption tends to be regionalized, use of PEVs is changing electricity consumption patterns at the local level, and the vehicles are prevalent enough to require thoughtful planning for public charging infrastructures.

### **Regionally constrained water availability**

At the time of publication of this report, California was experiencing its fourth year of an historic drought. Hydroelectric production in California was 60% lower in 2014 than it was in the most recent wet year (2010).<sup>44</sup> Additionally, the state is expending more energy than usual for water delivery due to the pumping of groundwater by the agriculture industry to keep its fields and orchards productive during current drought conditions. California is an example of what can happen when water availability is altered. In regions that rely on river flow for power plant cooling, a drought could threaten the operability of those power plants.

### **Reductions in carbon dioxide (CO<sub>2</sub>) emissions**

U.S. CO<sub>2</sub> emissions from fossil fuels have declined by 10% since 2005, and were virtually unchanged between 2010 and 2014, despite significant economic growth during that time.<sup>45</sup> Key factors contributing to this trend include reductions in demand growth for gasoline and electricity, fuel switching from coal to lower-carbon natural gas in the electricity sector, and growth in electricity generation from wind and solar. Globally, the rate of growth of emissions has slowed as well. In 2014, global CO<sub>2</sub> emissions were unchanged from 2013.<sup>46</sup>

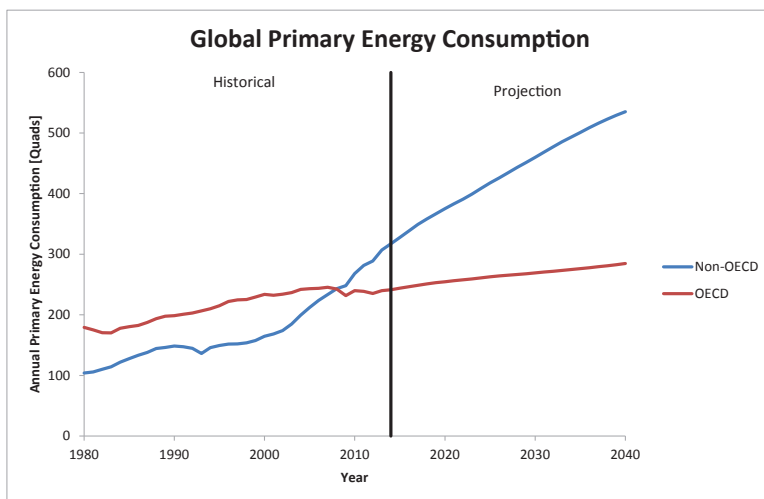


**Table 1.1** Changes in Energy Supply and End-Use Demand from 2010 through 2014

Sector	2010	2014
Domestic oil and liquids production <sup>10</sup>	7.56 MMB/d (million barrels/day)	11.7 MMB/d
Oil demand <sup>11</sup>	19.2 MMB/d	19.0 MMB/d
Net oil imports <sup>12</sup>	9.44 MMB/d	5.04 MMB/d
Coal consumption <sup>13</sup>	1,050 Mt (million short tons)	917 Mt
Unconventional natural gas production <sup>14</sup>	5.8 TCF (trillion cubic feet)	11.9 TCF (2013)
Natural gas generating capacity <sup>15,16</sup>	407 GW (gigawatts)	432 GW
Nuclear power	One reactor under construction	Five reactors under construction
Wind generating capacity, cumulative <sup>17</sup>	40.3 GW	65.9 GW
Photovoltaic generating capacity, cumulative <sup>18,19</sup>	2.02 GW	18.3 GW
Electricity end use <sup>20</sup>	3,887 Billion kWh (BkWh)	3,862 BkWh
<b>Total energy demand<sup>21</sup></b>	<b>97.5 quads</b>	<b>98.4 quads</b>
<b>Total population<sup>22</sup></b>	<b>309 million people</b>	<b>319 million people</b>
<b>Total economy (gross domestic product)<sup>23</sup></b>	<b>\$14.8 trillion (chained-2009-\$)</b>	<b>\$16.0 trillion</b>

today’s 330 quads to roughly 530 quads in 2040 (see Figure 1.5). This burgeoning growth is a substantial market opportunity but will also increase the pressure on global energy supplies, with corresponding security and market volatility risks.

**Figure 1.5** EIA Projections for Growth of Energy Demand (in quads) in OECD and non-OECD Markets to 2040. The growth in the emerging economies is projected to be five times faster than that of the OECD nations over the next twenty-five years. (Source: EIA International Energy Outlook, 2013, Figure 14)



### 1.3 National Energy System Strategic Objectives

As in the past, the future energy system will be influenced by many factors, some of which are technology developments, others which are not. An appropriate RDD&D agenda endeavors to anticipate and incorporate all potential factors, including those that are still emerging and evolving. In the face of the inevitable uncertainties, three definitive and enduring goals are foundational to the nation’s energy RDD&D agenda.

## U.S. Energy Objectives

**Secure and resilient:** Energy systems should be secure from and resilient to natural disruptions as well as man-made attacks. Security must be addressed along the entire energy service value chain from supply (including energy resources, materials, and technologies) to operations (including distribution, storage, and end use of fuels and electricity).

**Economically competitive:** Energy systems should provide energy services that are abundant, sustainable, and affordable, taking into account the full market impacts and life cycle costs of the energy service value chain.

**Environmentally responsible:** Clean energy systems should minimize air, water, and land pollutant emissions; GHG emissions; biota impacts; and disruption of water and land resources.

Fully successful energy systems will be secure and resilient, economically competitive, and environmentally responsible. Such systems will include a portfolio of technologies whose inherent strengths are complementary and weaknesses are mitigated. Future uncertainties make it prudent to explore multiple technologies and approaches. A diversified portfolio of technology options is essential to mitigating risk.

### 1.3.1 Energy Security and System Resiliency

Energy-related risks to national security can broadly be categorized into physical, cyber, economic, and conflict-related, though significant overlaps among these categories exist. Energy technologies must be robust and resistant to these vulnerabilities.

**Physical** security risks are related to damage to energy supply, storage, and delivery infrastructures. These infrastructures include the electrical grid, pipeline networks, and rail and marine systems.<sup>47</sup> Hurricane Sandy<sup>48</sup> and the attack on the Metcalf substation<sup>49</sup> are recent examples that highlight the physical vulnerabilities of energy systems to natural and man-made threats. The increase in extreme weather with climate change raises these risks.<sup>50</sup>

**Cybersecurity** vulnerabilities generally are related to the compromise of computer-based systems in their various activities of data inputs and analysis and, more specific to energy systems, the operation and coordination of energy supply, delivery, and end-use systems. The challenges of maintaining the integrity of these systems correspond with the number of access points to these systems, the need to validate and manage data inputs, the need to monitor the systems for intrusion, and the need to address other vulnerabilities. Private networks face cybersecurity challenges that increase with access to the Internet.

**Economic** security risks are related to price shocks and international supply disruptions of energy commodities, critical materials, and/or equipment. Globally traded energy commodities are subject to rapid price swings from a diverse range of geopolitical factors. These price shocks create uncertainty for energy-dependent businesses, which, in turn, can reduce investment and productivity. Major energy suppliers could manipulate the market by shifting output levels. Additionally, the manufacturing of large energy infrastructure components can be dependent on global supply chains that may be subject to long lead times, long-range shipping logistics, and price volatility.



**Conflict-related** security risks are related to unrest in foreign countries. Energy-related international security risks include those that involve unrest in locations that are critical to global energy supply, unrest driven by energy prices, and climate change-induced risks such as crop failure, water shortages, or extreme weather. These factors may increase risks to the United States.<sup>51,52</sup>

### 1.3.2 Economic Impacts

Energy costs are embedded in nearly every aspect of the U.S. economy. The total cost of energy supplies to end users in the United States was roughly \$1.2 trillion in 2010,<sup>53</sup> or about 8% of the total gross domestic product.<sup>54</sup> Improved energy technologies can enhance economic activity by reducing energy costs, improving supply reliability, reducing energy imports, and expanding markets for energy technology.

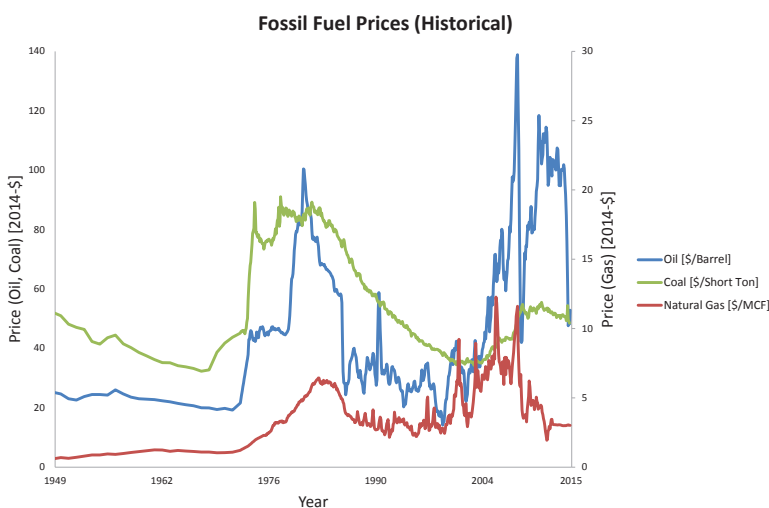
**Energy costs:** The costs of energy are determined by a complex interplay of the primary energy commodity supplies available at a given price, the capital and operating costs of converting these supplies into energy services, and the demand for these energy services. This also leads to competition among energy resources and services, with alternatives that can serve as substitutes. The costs associated with security or environmental externalities are often not fully included in the market price.

Reduced energy costs generally contribute to improved performance in many sectors of the economy. In addition, cost-effective efficiency measures (e.g., appliance standards, weatherization) can provide more disposable income for individual consumers. Lower oil prices benefit consumers broadly but can reduce employment in the oil industry. Cost reductions for solar and wind electric power generation can affect the competition with other, more traditional generation options.

Energy systems all respond at different rates to changes in prices and technology developments. Energy prices respond to supply and demand in the market and are volatile, as illustrated in Figure 1.6, and notoriously difficult to predict. End-use fuel demand is relatively inelastic in the short term, in that small changes in supply can cause large shifts in prices. Factors as diverse as inventory adjustments, economic activity, geopolitical events, and market speculation can drive volatility on various timescales. This volatility complicates business planning, which could negatively impact the economy. Having a diversified portfolio comprising different energy supply and use

technologies provides “options” value and can allow one to hedge the risk of being dependent on a single energy supply. Reducing fuel use through improved efficiency can also moderate steep price changes.

**Figure 1.6** Energy Prices by Year for the Coal, Natural Gas, and Oil Markets. Note the substantial price volatility, which can be even more pronounced when examined over a shorter time frame.<sup>55</sup>



**Disruption-related losses:** Power outages cause substantial economic costs to the businesses they affect. A 2006 study by Lawrence Berkeley National Laboratory estimated that disruptions to the U.S. electric power system cost from \$22 to \$135 billion per year due to normal weather events,



downed trees, and equipment failure.<sup>56</sup> A more recent study found outage-related costs ranging from \$20 to \$50 billion per year for weather-related outages alone. These estimates do not include the damage from extreme weather events, such as Hurricane Ike in 2008<sup>57</sup> or Hurricane Sandy in 2012.<sup>58</sup> Reducing these costs through improvements to the transmission and distribution system would benefit the economy as a whole.<sup>59</sup>

**Energy imports:** Expenditures for energy imports go to external producers and can be a substantial component of the U.S. trade deficit. Net petroleum imports cost the U.S. economy approximately \$190 billion in 2014.<sup>60</sup> During the next twenty years, the International Energy Agency (IEA) projects substantial pressure on global oil markets as global demand continues to grow;<sup>61</sup> others project this can be managed.<sup>62</sup> With international sales of coal, natural gas, and refined products, the United States may become a net energy exporter, but crude oil imports will continue and U.S. oil prices will remain tied to global prices.<sup>63</sup> Reducing dependence on imports reduces the potential impact of supply disruptions by keeping more of the additional expenditures within the domestic economy.

**Energy technology markets:** Production and export of energy equipment represents a substantial market opportunity for the United States that would generate high-value jobs. For example, the IEA forecasts that clean energy will provide \$7 trillion of the \$10 trillion invested in electricity generation capacity growth over the next twenty years, of which \$6 trillion will be in renewables and \$1 trillion will be in nuclear power. Nearly two-thirds of this investment will be in the emerging economies. Energy efficiency investments will account for a further \$8 trillion of investment.<sup>64,65,66</sup>

### 1.3.3 Environmental Impacts

Energy production, delivery, and end use can have significant detrimental impacts on the environment. Air and water quality have historically been the primary concerns. More recently, issues of land/water availability, ecosystem health, and the global climate have joined the list.

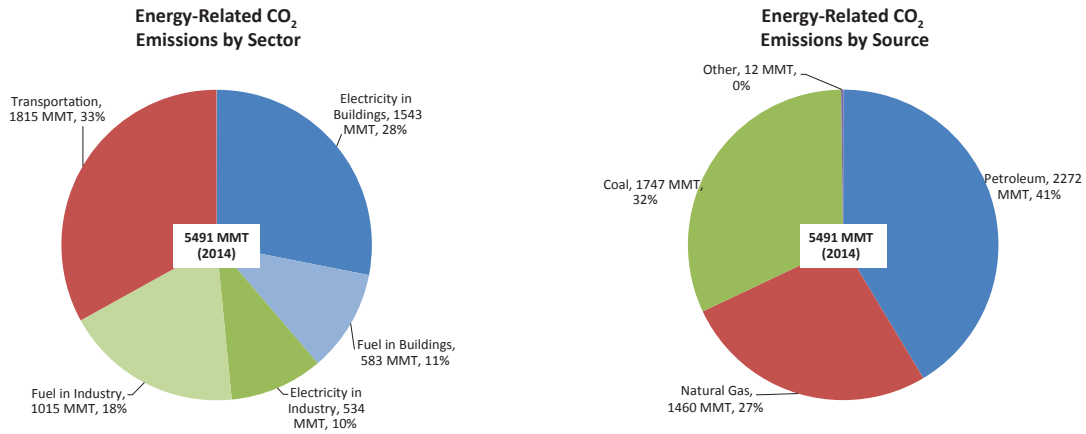
**Air pollution:** Criteria pollutants, such as sulfur oxides, nitrogen oxides, particulate matter, and volatile organic compounds, are released into the atmosphere by the combustion of fuels in power plants, vehicles, industry, and building equipment. Some pollutants are directly harmful to human health while others participate in atmospheric chemical reactions that generate harmful conditions such as ground-level ozone. Technology options for further reducing air pollution from energy systems can be made available through RDD&D on both systems that can control these emissions and through developing alternatives that do not produce pollutants.<sup>67,68,69</sup>

**GHG emissions:** Gases such as water vapor, carbon dioxide (CO<sub>2</sub>), methane, and nitrous oxide increase the global temperature via the greenhouse effect.<sup>70,71,72</sup> The concentration of CO<sub>2</sub>—the predominant long-lifetime GHG—in the atmosphere has increased from about 280 parts per million (ppm) by volume during pre-industrial times to about 400 ppm today, a 40% increase.<sup>73</sup> Figure 1.7 identifies U.S. energy-related emissions of CO<sub>2</sub> by source and sector. U.S. fossil fuel use currently results in the emission of about 5.3 billion metric tonnes of CO<sub>2</sub> into the atmosphere each year. This total includes uses for energy, non-energy (e.g., feedstocks), and industrial uses such as iron and cement production.

Climate change resulting from the the increase in GHG emissions in the atmosphere is already being observed and is projected to increase with the continued release of these emissions. Such changes include temperature increases, sea-level rise, and an increase in the frequency and intensity of certain extreme weather events (e.g., more intense regional precipitation and drought events).<sup>74</sup> In addition, increases in atmospheric concentrations of CO<sub>2</sub> inevitably lead to increased absorption of CO<sub>2</sub> by the oceans, which causes ocean acidification.<sup>75</sup> Addressing the climate and ocean acidification challenges requires the development and deployment of energy supply technologies that either control emissions, such as through carbon capture and storage, or that do not release GHG emissions, such as nuclear or renewable energy.



**Figure 1.7** U.S. CO<sub>2</sub> Emissions by (a) Primary Energy Source as a percent of total U.S. energy-related CO<sub>2</sub> emissions (in million metric tonnes); and (b) End Use Sector, including the share for industry and buildings that is from purchased electricity used in that sector, but not including self-generated electricity.<sup>76</sup> Other GHG emissions such as methane are not included here.



**Water:** Energy-related environmental impacts on water include pollutant discharges, thermal impacts of waste heat discharge, consumption of freshwater, and impacts on aquatic life. Pollutants include acids and toxics, and these can come from deposition of air pollution, acid runoff from mining operations, release of coal ash into lakes or rivers, contamination from energy resource extraction operations, absorption of the increased levels of CO<sub>2</sub> in the atmosphere, and other sources.<sup>77,78</sup> Continued emissions of CO<sub>2</sub> will further acidify the ocean with serious impacts on ocean life.

These potential impacts motivate energy RDD&D to develop technologies that, for example, reduce atmospheric emissions of pollutants (some of which ultimately go into water), control acids or toxics that go directly into water, reduce thermal loading from cooling systems by improving efficiencies and by switching to closed loop or dry cooling systems, and reduce emissions of CO<sub>2</sub>.

**Land:** Environmental impacts on land can take many forms, such as deposition of atmospheric pollutants or direct discharge of pollutants (e.g., as coal ash) and physical disruption from fuel extraction/production or associated with energy plant and infrastructure siting. Physical disruption can take many forms, from mountaintop mining,<sup>79</sup> to land used for oil and gas operations,<sup>80</sup> to use of agricultural or other land to grow bioenergy crops, to placing wind turbines on farm or ranchland, each with differing degrees of disruption.<sup>81</sup> Another potential impact is induced seismicity (i.e., earthquakes) caused by injecting water into the subsurface (for hydraulic fracturing or disposal) associated with oil and gas extraction or waste water disposal, as well as geothermal energy operations.<sup>82,83,84,85</sup>

Over the last several decades, significant progress has been made in reducing pollution—atmospheric, water, land—from energy-related activities. Energy-related atmospheric emissions of conventional pollutants such as particulates, sulfur, and nitrogen compounds have been reduced through improved combustion strategies and “end-of-pipe” (e.g., scrubbers, catalytic converters) emissions controls. Additional progress has occurred by transitioning to cleaner fuels and renewable resources. These successes indicate what can be accomplished with RDD&D and policy. Advanced technologies can have a significant impact on the next generation of challenges, especially deep reductions in GHG emissions. The United States can demonstrate the viability of sustainable energy systems to the global community to provide leadership in creating vibrant economies, enhancing human progress, and assuring a sustainable biosphere.

## 1.4 Context for Evolving Energy Systems

There are many challenges to meeting the objectives of a secure, resilient, economically competitive, and environmentally responsible energy system. RDD&D opportunities should be considered in the context of the size and inertia of the energy system, as well as the costs to develop and deploy energy technologies. There are important public and private roles in helping the U.S. energy enterprise overcome these challenges.

### 1.4.1 Size

U.S. energy infrastructure is woven throughout the fabric of the economy. The costs required to modify these energy systems are proportional to the scale of the systems and compounded by their complexity, but moderated by the advanced age of many of these systems and the need to replace them.

**Energy supply and infrastructure:** The United States currently has about 1,000 GW of power plants,<sup>86</sup> with slightly more than 19,000 electric generators with individual capacities of one megawatt or more at about 7,000 operational sites and many more small, distributed facilities all connected to 640,000 miles of transmission lines and 6.3 million miles of distribution lines.<sup>87</sup> It also has about 140 refineries<sup>88</sup> and the associated infrastructure of wells, pipelines, and terminals. The transportation system depends on some 2.6 million miles of interstate and intrastate roads<sup>89</sup> as well as 140,000 miles of Class I railroads.<sup>90</sup> Each of these infrastructures is interconnected to non-energy systems such as water and communications.<sup>91</sup>

**End-use:** In 2012, there were more than 5.6 million commercial buildings with a total of 87 billion square feet of floor space;<sup>92</sup> about 115 million residential households;<sup>93</sup> and about 250 million light-duty vehicles,<sup>94</sup> which traveled a total of almost 2.7 trillion miles.<sup>95</sup>

**Numerous stakeholders:** A challenge of implementing new technologies is the number of actors that must be engaged, ranging from more than 600,000 firms involved in the construction industry, 250,000 companies across the manufacturing sector, 17,000 firms across the supply chains for appliances and vehicles, more than 3,000 electric utilities and cooperatives, and, of course, more than 300 million consumers.<sup>96</sup>

### 1.4.2 Inertia

The scale of the energy system inevitably results in significant inertia. It would take decades to fully replace existing assets with advanced energy technologies.

**Electric power:** In electric generation, transmission, and distribution systems, the need to replace aging equipment opens the door for introducing significant new technologies to address the challenges facing this sector. However, equipment can last three or four decades or more, slowing the introduction of advanced technology. Siting generation, transmission, and distribution systems can also take long periods.

**Buildings:** Given lifetimes of buildings of sixty to eighty years, turnover in the building stock itself will have limited impact on energy use in the near- to mid-term. Technologies to retrofit buildings for much higher efficiency at low cost will be important to capture significant energy savings and emissions benefits in the near term that otherwise would wait decades before the existing building stock was replaced. RDD&D on energy technologies for new buildings is also important because buildings that are designed for optimal energy performance and flexibility can capture decades of energy savings. In contrast, the furnaces, appliances, and other equipment within buildings last approximately ten to twenty years, so the RDD&D focus for them can be on advancing new equipment rather than retrofits.

**Manufacturing:** In the industrial sector, the high energy intensity of producing commodity materials encourages the introduction of new processes, plants, and equipment; partial retrofits may deliver energy and emissions returns much lower than the potential, while also missing many of the productivity and performance



benefits of the improved production process. However, replacing capital equipment can be difficult given the low returns on commodity materials. RDD&D to develop clean processes that also lower capital costs and increase productivity and performance are then particularly important.

**Transportation:** For the transportation sector, the typical fifteen-year lifetime of vehicles means the vehicle fleet in the United States will turn over multiple times by 2050, allowing the introduction of several new generations of technology. More challenging is the modernization of the fueling, vendor, and service infrastructures to sustain the vehicle fleet—a process that may require longer periods. The underlying infrastructure of roads, rails, airports, and waterways will change even more slowly, constraining system evolution.

The energy infrastructure that evolved over the past century was designed for conventional technologies. New fuels and systems that are not adequately compatible with the existing infrastructure, such as hydrogen fuel cell vehicles, would require new infrastructures for fuel production and delivery, as well as new supply chains for equipment manufacture. This poses a “chicken-and-egg” dilemma: without a widely distributed fueling infrastructure it is harder to convince potential vehicle purchasers to buy, and without sufficient vehicles it is hard to pay for a large refueling infrastructure. This can impede technology introduction.

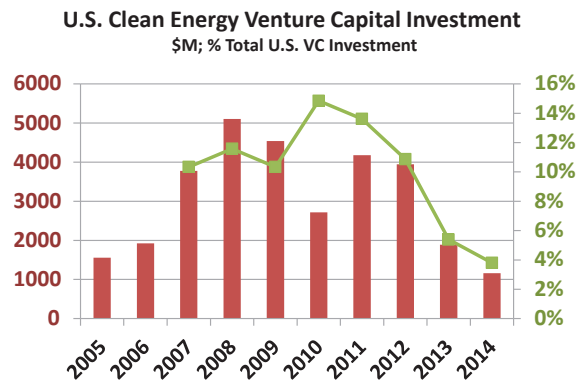
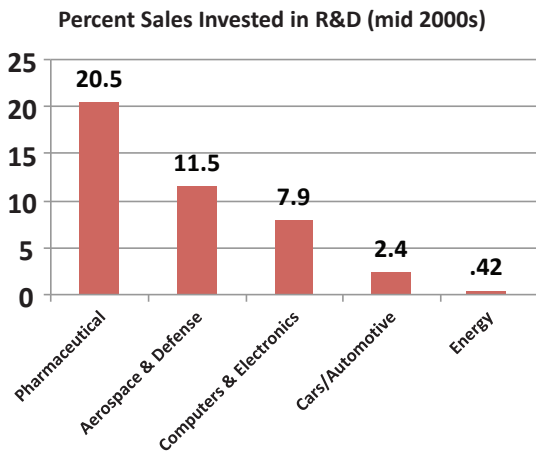
Finally, the time required to conduct energy technology research varies by technology and sector, but can be many years. While turnover of existing energy system assets limits the demand for new energy technologies, the pace of advanced energy technology innovation, a function in part of the resources devoted to RDD&D, affects the supply of new technologies to energy markets.

### 1.4.3 Research and Development Investments

Overall, the energy sector makes relatively limited R&D investments in comparison with other sectors (Figure 1.8a). Corporate investments in clean energy R&D have remained in the range of \$3 to \$4 billion from 2006 to 2014.<sup>97</sup> Venture capital funding has generally declined from its peak in 2008 (Figure 1.8b). In part, this may be due to the long time frames for returns on energy R&D. Directed basic research and early applied R&D can require as much as a decade or more to demonstrate bench-level results, indicating that a useful technology might be developed. Then, successful technologies for producing fuels or electricity, for example, are competing in low margin commodity markets and thus face a significant challenge in generating high returns. These pose challenges for private investors.

**Figure 1.8** (a) Percentage of Gross Sales Invested in R&D for Selected Sectors of the U.S. Economy.<sup>98</sup> (b) U.S. Clean Energy Venture Capital Investment. The investment in RDD&D is low for energy compared with the other sectors listed, and is also a low and recently declining share of venture capital investment.<sup>99</sup>

Credit: American Energy Innovation Council



### 1.4.4 Economies of Scale and Learning

**Economies of scale:** Economies of scale occur in several forms. Conventional power plants and refineries, for example, are built in scales of hundreds of megawatts to multiple gigawatts to capture economies of scale and improve efficiency in generating power or refining fuels. For some applications, however, larger scales have been found to increase costs due to the extensive on-site fabrication required, and the cost of integrating multiple complex systems.

Economies of scale are also realized in manufacturing, where large-volume production of individual devices provides savings. For example, more than 40% of the cost reduction in silicon photovoltaic production from 1980 to 2001 was due to economies of scale in the plant size.<sup>101</sup> To capture economies of scale, a company needs to have some expectation that it will be able to sell product from a larger plant over a sufficient period to get a return on its investment. Very large plants needed to capture economies of scale can be extremely capital intensive and pose substantial, often multibillion dollar risks for companies.

**Economies of learning:** In general, the cost of a given technology declines as cumulative production increases and, thus, with deployment (Figure 1.9). This is interpreted as “learning by doing” to drive cost reduction.<sup>102</sup> The pace of learning varies by technology. For example, photovoltaic modules have demonstrated cost reductions per kilowatt of about 20% with each doubling of production over the past forty years; wind turbines demonstrated about 15% for each doubling from 1980 to 1995; and natural gas-fired combined cycle turbines have demonstrated about 5% learning for each doubling over the past twenty years.

R&D is important within this framework, as its ability to lower costs and improve performance can have an important impact on deployment. In addition, R&D may impact the ability of the technology to benefit from economies of scale—particularly in manufacturing—and learning.

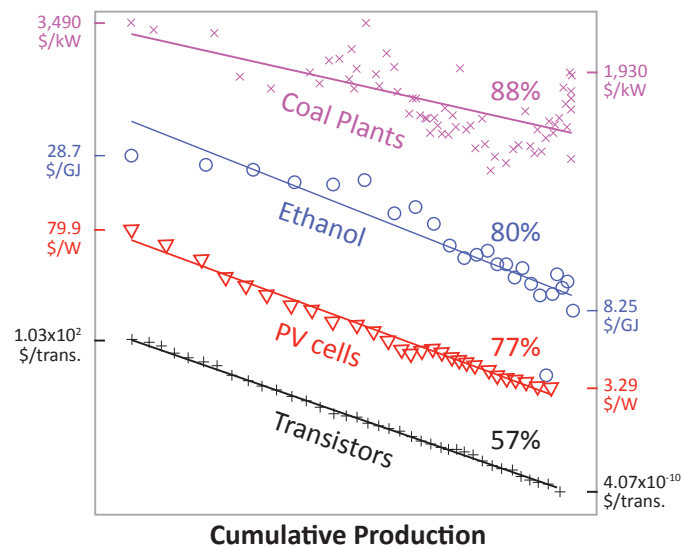
The need for large-volume production poses a chicken-and-egg problem for manufacturing. On the one hand, large volumes are required to drive prices down; on the other hand, low prices are required to sell into the market and achieve these volumes.

### 1.4.5 Demonstration and Deployment

Mobilizing capital for clean energy demonstration and deployment faces many challenges. Energy supply technologies often take years to commercialize, require relatively large front-end capital investments, and then supply commodity fuels or power with relatively low margins. This means that net returns on major capital projects can be negative for long periods of time. For advanced energy efficient technologies, capital costs are generally higher than for the incumbent technology even though their life cycle costs typically are

**Figure 1.9** Learning Curves for Selected Technologies<sup>100</sup>

Credit: National Academy of Sciences





lower. Purchasers are generally wary of high capital costs, and this sensitivity is increased for a relatively new technology, which may have performance risk or uncertainty due to immaturity. These finance challenges can occur at several development stages described below:

- Basic feasibility stage, where new technologies are translated into early functioning hardware
- Demonstration stage, where the technology is scaled up to demonstrate performance at a commercial scale
- Commercial viability stage, where the new technology can enter markets
- Economic viability stage, when the technology can provide significant return

These stages pose challenges in mobilizing needed resources and requiring considerable time to realize a return. The volatility of energy markets and changing policies can complicate these challenges.

Finally, once a technology is demonstrated as viable, it is much easier for a competitor to copy it or find alternative approaches to achieve the same thing. This can sharply reduce the financial return for the innovator as well as the incentive to invest.

The various steps of research, development, demonstration, and deployment have many interactions and feedbacks among all of them as the work progresses, making it more of an interwoven tapestry of activities than the conventional linear depiction.<sup>103</sup> Thus, in the following chapters, the term RDD&D is typically used rather than individually identifying a particular stage within this process.

## 1.5 Energy Technology Assessments

As described above, current patterns of energy use pose substantial challenges, but developing new energy technologies can address these challenges and open new market opportunities. This QTR identifies many important technologies to do this. Countless technologies could be considered, so criteria were employed to narrow this set down to the manageable number addressed in the subsequent chapters. Building on the work of QTR 2011, the following criteria were used to select energy technologies for QTR 2015:

- **Maturity (and time period):** Technologies should have the potential for significant advances in cost, performance, or other key metrics with further RDD&D that can lead to commercialization in the mid-term and beyond.
- **Materiality (impacts):** The system and associated technologies, in aggregate, should have the potential to save or supply at least 1% of the primary energy of the United States or of a region, or similarly impact a key energy-linked challenge such as reducing carbon emissions.
- **Market potential:** The system or technology should have significant potential to succeed in competitive markets, recognizing that markets are driven by economics and shaped by public policy.
- **Public benefits:** The system or technology should have significant public benefits, such as improvements in public safety and security; much lower emissions of CO<sub>2</sub> or other pollutants; reductions in environmental impacts to land, water, or biota; or others.
- **Public role:** The system or technology should be one that provides value to the public, that the private sector is unlikely to undertake the RDD&D at sufficient scale alone, and for which the public contribution can make a significant impact in advancing the technology.

Technology areas discussed in the subsequent chapters are examined and evaluated against these criteria, with occasional adjustment to allow for differences in regional energy needs and resources or for technologies with very long development cycles (e.g., fusion).

In addition, the following attributes were considered:

**Crosscutting applicability:** Inevitably, many technology themes transcend specific application areas. Advances in one area can lead to benefits in others. These crosscutting opportunities span numerous energy systems such as grid integration, subsurface science, advanced materials, modeling and simulation, data and analysis, decision science, cybersecurity, energy storage, and broadly considered efficiency. A more comprehensive discussion of crosscutting activities can be found in Chapters 2 and 11.

**Improved services:** New energy systems developed for improved efficiencies can often provide better services. A recently commercialized example includes solid-state, light-emitting diodes (LEDs), which can deliver a better quality of light than their fluorescent or incandescent predecessors at significantly lower energy consumption.

**Price advantages:** The availability of low-cost energy supplies within the United States can provide a market advantage for U.S. production of energy-intensive products, such as chemicals or forest products. Efficiency measures that reduce energy demand help reduce market pressure on energy prices.

**Energy technology exports:** As a leader in R&D on many energy technologies, the United States has the opportunity to lead the world in developing and manufacturing new clean energy technologies, although it currently does not take advantage of this.<sup>104</sup> Global clean electricity supply and energy efficiency markets are estimated by the IEA to total \$7 trillion and \$8 trillion, respectively, by 2035. Producing for such large markets, together with technology and manufacturing advances, can move new energy technologies rapidly down the learning curve to lower costs.<sup>105,106</sup> Those countries and companies that are able to drive these costs down first may capture a large first-mover advantage. Further, they develop the advantages of building strong supplier networks for the needed inputs, a skilled workforce, and the downstream companies that integrate the energy technology into systems for sale in markets around the world. Production and export of energy equipment represents a substantial market opportunity for the United States that would generate high-value jobs; conversely, if the United States ends up importing much of its energy technology, this could impact the U.S. trade balance, taking the place of fuels that are imported today.

## Supplemental Information

[Additional Information on Energy Challenges](#)

[Agency Information](#)

[Representative DOE Applied Energy Program Workshops](#)

[See online version.]



## Endnotes

- <sup>1</sup> Mai, T.; Mulcahy, D.; Hand, M.M.; and Baldwin, S.F. 2014. "Envisioning a renewable electricity future for the United States." *Energy* 65 (2014) pp. 374-386.
- <sup>2</sup> Lawrence Livermore National Laboratory. 2015. "Estimated U.S. Energy Use in 2014." <https://flowcharts.llnl.gov/>.
- <sup>3</sup> Annual Energy Outlook 2015 with Projections to 2040. DOE/EIA-0383(2015). Washington, DC: U.S. Energy Information Administration, 2015. <http://www.eia.gov/forecasts/aeo/>.
- <sup>4</sup> National Transportation Statistics 2015. Washington, DC: U.S. Department of Transportation Bureau of Transportation Statistics. [http://www.rita.dot.gov/bts/sites/rita.dot.gov/bts/files/publications/national\\_transportation\\_statistics/html/table\\_04\\_04.html](http://www.rita.dot.gov/bts/sites/rita.dot.gov/bts/files/publications/national_transportation_statistics/html/table_04_04.html).
- <sup>5</sup> Monthly Energy Review. DOE/EIA-0035(2015/07). Washington, DC: U.S. Energy Information Administration. <http://www.eia.gov/totalenergy/data/monthly/index.cfm>.
- <sup>6</sup> Annual Energy Outlook. EIA, DOE/EIA-0383(2014), Washington, DC: U.S. Energy Information Administration. [http://www.eia.gov/forecasts/aeo/pdf/0383\(2014\).pdf](http://www.eia.gov/forecasts/aeo/pdf/0383(2014).pdf).
- <sup>7</sup> "Consumption and Efficiency." U.S. Energy Information Administration, 2015. <http://www.eia.gov/consumption/manufacturing/data/2010/#r3>.
- <sup>8</sup> "History of energy consumption in the United States, 1775–2009." U.S. Energy Information Administration, 2011. <http://www.eia.gov/todayinenergy/detail.cfm?id=10>.
- <sup>9</sup> Monthly Energy Review, DOE/EIA-0035(2014/07). Washington, DC: U.S. Energy Information Administration. Table 1.1 Primary Energy Overview. <http://www.eia.gov/totalenergy/data/monthly/archive/00351407.pdf>.
- <sup>10</sup> "Petroleum & Other Liquids - Supply and Disposition," U.S. Energy Information Administration (EIA), 2015. Accessed August 5, 2015: [http://www.eia.gov/dnav/pet/pet\\_sum\\_snd\\_d\\_nus\\_mbbldp\\_a\\_cur-4.htm](http://www.eia.gov/dnav/pet/pet_sum_snd_d_nus_mbbldp_a_cur-4.htm).
- <sup>11</sup> Ibid.
- <sup>12</sup> Ibid.
- <sup>13</sup> "Monthly Energy Review." U.S. Energy Information Administration (EIA), 2015. Accessed March 15, 2015: <http://www.eia.gov/totalenergy/data/monthly/index.cfm>.
- <sup>14</sup> "Natural Gas Summary," U.S. Energy Information Administration (EIA), 2015. Accessed August 5, 2015: [http://www.eia.gov/dnav/ng/ng\\_sum\\_lsum\\_dcu\\_nus\\_a.htm](http://www.eia.gov/dnav/ng/ng_sum_lsum_dcu_nus_a.htm).
- <sup>15</sup> "Electricity Generating Capacity," U.S. Energy Information Administration (EIA), 2013. Accessed August 5, 2015. <http://www.eia.gov/electricity/capacity/>.
- <sup>16</sup> "Electric Power Monthly," U.S. Energy Information Administration (EIA), 2015. Accessed August 5, 2015. <http://www.eia.gov/electricity/monthly/>.
- <sup>17</sup> "U.S. Wind Industry Fourth Quarter 2014 Market Report." American Wind Energy Association, January 2015. Accessed March 15, 2015: <http://www.awea.org/Resources/Content.aspx?ItemNumber=7150>.
- <sup>18</sup> Sunshot Initiative - Tackling Challenges in Solar: 2014 Portfolio. DOE/EE-1081. Washington, DC. U.S. Department of Energy. Office of Energy Efficiency and Renewable Energy, Solar Energy Technologies Office. May, 2014. <http://energy.gov/eere/sunshot/2014-sunshot-initiative-portfolio-book>.
- <sup>19</sup> Mike Munsell, "The US Installed 6.2GW of Solar in 2014, Up 30% Over 2013," GreenTech Solar, March 10, 2015 <http://www.greentechmedia.com/articles/read/the-us-installed-6.2-gw-of-solar-in-2014-up-30-over-2013>.
- <sup>20</sup> U.S. Energy Information Administration, "Monthly Energy Review, July 2015, DOE/EIA-0035(2015/07) Table 7.a End Use Total.
- <sup>21</sup> "Monthly Energy Review." U.S. Energy Information Administration (EIA), 2015. Accessed March 15, 2015: <http://www.eia.gov/totalenergy/data/monthly/index.cfm>.
- <sup>22</sup> "State and County Quick Facts - USA," U.S. Census Bureau. Accessed August 5, 2015: <http://quickfacts.census.gov/qfd/states/00000.html>.
- <sup>23</sup> "Real Gross Domestic Product, Chained Dollars," Bureau of Economic Analysis, U.S. Department of Commerce, 2015. Accessed August 5, 2015. <http://www.bea.gov/iTable/iTableHtml.cfm?reqid=9&step=3&isuri=1&904=2010&903=6&906=a&905=2014&910=x&911=0>.
- <sup>24</sup> "Crude Oil plus Lease Condensate Proved Reserves, Reserves Changes and Production." U.S. Energy Information Administration (EIA), 2014. Accessed March 15, 2015: [http://www.eia.gov/dnav/pet/pet\\_crd\\_cplc\\_dcu\\_NUS\\_a.htm](http://www.eia.gov/dnav/pet/pet_crd_cplc_dcu_NUS_a.htm).
- <sup>25</sup> "Monthly Energy Review." U.S. Energy Information Administration (EIA), 2015. Accessed March 15, 2015: <http://www.eia.gov/totalenergy/data/monthly/index.cfm>.
- <sup>26</sup> "Natural Gas Proved Reserves, Wet After Lease Separation." U.S. Energy Information Administration (EIA), 2014. Accessed March 15, 2015: [http://www.eia.gov/dnav/ng/ng\\_enr\\_wals\\_a\\_EPG0\\_R21\\_Bcf\\_a.htm](http://www.eia.gov/dnav/ng/ng_enr_wals_a_EPG0_R21_Bcf_a.htm).
- <sup>27</sup> "Monthly Energy Review." U.S. Energy Information Administration (EIA), 2015. Accessed March 15, 2015: <http://www.eia.gov/totalenergy/data/monthly/index.cfm>.



- <sup>28</sup> “Per capita VMT drops for ninth straight year; DOTs taking notice.” State Smart Transportation Initiative (SSTI). 2014: Accessed October 12, 2014: <http://www.ssti.us/2014/02/vmt-drops-ninth-year-dots-taking-notice/>.
- <sup>29</sup> Energy Independence and Security Act of 2007 (EISA). Public Law 110-140, 110th Congress. December 19, 2007. <http://www.gpo.gov/fdsys/pkg/STATUTE-121/pdf/STATUTE-121-Pg1492.pdf>.
- <sup>30</sup> 2017 and Later Model Year Light-Duty Vehicle Greenhouse Gas Emissions and Corporate Average Fuel Economy Standards. U.S. Environmental Protection Agency and U.S. Department of Transportation, Washington, DC. October 15, 2012. <http://www.gpo.gov/fdsys/pkg/FR-2012-10-15/pdf/2012-21972.pdf>.
- <sup>31</sup> “Light-Duty Automotive Technology, Carbon Dioxide Emissions, and Fuel Economy Trends: 1975 - 2014.” U.S. Environmental Protection Agency (EPA) 2015. Accessed March 31, 2015: <http://www.epa.gov/fueleconomy/fetrends/1975-2014/420r14023a.pdf>.
- <sup>32</sup> “Monthly Energy Review.” U.S. Energy Information Administration (EIA), 2015. Accessed March 15, 2015: <http://www.eia.gov/totalenergy/data/monthly/index.cfm>.
- <sup>33</sup> Ibid.
- <sup>34</sup> WTI (NYMEX) Price for Crude Oil.” Nasdaq, 2015. Accessed March 31, 2015: <http://www.nasdaq.com/markets/crude-oil.aspx?timeframe=1y>.
- <sup>35</sup> “Nuclear Power in the World Today.” World Nuclear Association, 2015. Accessed March 31, 2015: <http://www.world-nuclear.org/info/Current-and-Future-Generation/Nuclear-Power-in-the-World-Today/>.
- <sup>36</sup> “U.S. Wind Industry Fourth Quarter 2014 Market Report.” American Wind Energy Association, January 2015. Accessed March 15, 2015: <http://www.awea.org/Resources/Content.aspx?ItemNumber=7150>.
- <sup>37</sup> Sunshot Initiative - Tackling Challenges in Solar: 2014 Portfolio. DOE/EE-1081. Washington, DC. U.S. Department of Energy. Office of Energy Efficiency and Renewable Energy, Solar Energy Technologies Office. May, 2014. <http://energy.gov/eere/sunshot/2014-sunshot-initiative-portfolio-book>.
- <sup>38</sup> “Monthly Energy Review.” U.S. Energy Information Administration (EIA), 2015. Accessed March 15, 2015: <http://www.eia.gov/totalenergy/data/monthly/index.cfm>.
- <sup>39</sup> The American Recovery and Reinvestment Act Smart Grid Highlights - Jumpstarting a Modern Grid. DOE/GO-102014-63032. U.S. Department of Energy, Office of Electricity Delivery and Energy Reliability. October, 2014. [https://www.smartgrid.gov/document/american\\_recovery\\_and\\_reinvestment\\_act\\_smart\\_grid\\_highlight\\_jumpstarting\\_modern\\_grid](https://www.smartgrid.gov/document/american_recovery_and_reinvestment_act_smart_grid_highlight_jumpstarting_modern_grid).
- <sup>40</sup> Schewe, P., *The Grid, A Journey Through the Heart of Our Electrified World*. National Academies Press, 2007. ISBN: 978-0-309-10514-9. <http://www.nap.edu/catalog/11735/the-grid-a-journey-through-the-heart-of-our-electrified>.
- <sup>41</sup> “U.S. Economy and Electricity Demand Growth are Linked, but Relationship is Changing.” Today in Energy, U.S. Energy Information Administration (EIA), March, 2013. Accessed April 1, 2015: <http://www.eia.gov/todayinenergy/detail.cfm?id=10491>.
- <sup>42</sup> Thompson, J. “Booming Shale Gas Production Drives Texas Petrochemical Surge.” Federal Reserve Bank of Dallas. Fourth Quarter 2012. Accessed January 15, 2015: <http://www.dallasfed.org/assets/documents/research/swe/2012/swe1204h.pdf>.
- <sup>43</sup> “U.S. PEV Sales by Model.” U.S. Department of Energy, Alternative Fuels Data Center, 2014. Accessed October 30, 2014: <http://www.afdc.energy.gov/data/10567>.
- <sup>44</sup> “California Hydroelectric Statistics.” California Energy Commission Energy Almanac, 2015. Accessed May 7, 2015: <http://www.energyalmanac.ca.gov/renewables/hydro/>.
- <sup>45</sup> “Monthly Energy Review.” U.S. Energy Information Administration (EIA), 2015. Accessed March 15, 2015: <http://www.eia.gov/totalenergy/data/monthly/index.cfm>.
- <sup>46</sup> “Global energy-related emissions of carbon dioxide stalled in 2014.” International Energy Agency, March 13, 2015. Accessed April 1, 2015: <http://www.iea.org/newsroomandevents/news/2015/march/global-energy-related-emissions-of-carbon-dioxide-stalled-in-2014.html>.
- <sup>47</sup> U.S. Department of Energy, “Quadrennial Energy Review: Energy Transmission, Storage, and Distribution Infrastructure,” April 2015. <http://energy.gov/epa/quadrennial-energy-review-qer>.
- <sup>48</sup> U.S. Department of Energy. 2012. “Hurricane Sandy and Our Energy Infrastructure.” December. Accessed June 22, 2015: <http://energy.gov/articles/hurricane-sandy-and-our-energy-infrastructure>.
- <sup>49</sup> “Assault on California Power Station Raises Alarm on Potential for Terrorism.” The Wall Street Journal. February 5, 2014. Accessed June 22, 2015: <http://www.wsj.com/articles/SB10001424052702304851104579359141941621778>.
- <sup>50</sup> “U.S. Energy Sector Vulnerabilities to Climate Change and Extreme Weather,” U.S. Department of Energy, 2013. <http://energy.gov/downloads/us-energy-sector-vulnerabilities-climate-change-and-extreme-weather>.
- <sup>51</sup> Hsiang, S.M.; Burke, M.; and Miguel, E. 2013. “Quantifying the Influence of Climate on Human Conflict.” *Science* v. 341, 13 Sept. 2013, #1235367-1to14.
- <sup>52</sup> O’Loughlin, J.; Witmer, F.D.W; Linke, A.M.; Laing, A.; Gettelman, A.; Dudhia, J. “Climate variability and conflict risk in East Africa, 1990-2009.” *Proc. Nat. Acad. Sci* (109:45); pp. 18344–18349.
- <sup>53</sup> Annual Energy Review 2011. DOE/EIA 0384 (2011). Washington, DC: U.S. Energy Information Administration, 2012.
- <sup>54</sup> “GDP United States.” Data 360. [http://www.data360.org/dsg.aspx?Data\\_Set\\_Group\\_Id=230](http://www.data360.org/dsg.aspx?Data_Set_Group_Id=230).



- <sup>55</sup> U.S. Energy Information Administration, Annual Energy Outlook, Annual Energy Review, Monthly Energy Review, various years.
- <sup>56</sup> LaCommare, K.H. and J.H. Eto. 2006. "Cost of Power Interruptions to Electricity Consumers in the United States (U.S.)." LBNL-58164. Berkeley, CA: Lawrence Berkeley National Laboratory, 2006. <http://emp.lbl.gov/publications/cost-power-interruptions-electricity-consumers-united-states-us>. This study found a mean of \$79B/year, with a range of \$22B to \$135B depending on sensitivity assumptions used.
- <sup>57</sup> Campbell, R.J. 2012. "Weather-Related Power Outages and Electric System Resiliency." Congressional Research Service, August 28, 2012.
- <sup>58</sup> Executive Office of the President. 2013. "Economic Benefits Of Increasing Electric Grid Resilience To Weather Outages." August. [http://energy.gov/sites/prod/files/2013/08/f2/Grid%20Resiliency%20Report\\_FINAL.pdf](http://energy.gov/sites/prod/files/2013/08/f2/Grid%20Resiliency%20Report_FINAL.pdf).
- <sup>59</sup> Quadrennial Energy Review: Energy Transmission, Storage, and Distribution Infrastructure. Washington, DC: U.S. Department of Energy. 2015. <http://energy.gov/epsa/quadrennial-energy-review-qer>.
- <sup>60</sup> "U.S Trade in Petroleum and Non-Petroleum Products by End-Use," U.S. Census Bureau, 2015. Accessed August 5, 2015: [https://www.census.gov/foreign-trade/Press-Release/current\\_press\\_release/exh9.pdf](https://www.census.gov/foreign-trade/Press-Release/current_press_release/exh9.pdf).
- <sup>61</sup> International Energy Agency, "World Energy Outlook 2012," Fig. 3.15.
- <sup>62</sup> "No Evidence of Precipitous Fall on Horizon for World Oil Production: Global 4.5% Decline Rate Means No Near-Term Peak: CERA/HIS Study." Business Wire. January 17, 2008, <http://press.ihs.com/press-release/corporate-financial/no-evidence-precipitous-fall-horizon-world-oil-production-global-4>.
- <sup>63</sup> U.S. Energy Information Administration. 2015. "U.S. energy imports and exports to come into balance for first time since 1950s." April. Accessed June 22, 2015: <http://www.eia.gov/todayinenergy/detail.cfm?id=20812>.
- <sup>64</sup> IEA World Energy Investment Outlook," International Energy Agency, 2014, Accessed August 5, 2015: <http://www.iea.org/publications/freepublications/publication/WEIO2014.pdf>.
- <sup>65</sup> "World Energy Outlook 2014 Fact Sheet," International Energy Agency, 2014. Accessed August 5, 2015: [https://www.iea.org/media/140603\\_WEOinvestment\\_Factsheets.pdf](https://www.iea.org/media/140603_WEOinvestment_Factsheets.pdf).
- <sup>66</sup> "Spending on New Renewable Energy Capacity to Total \$7 Trillion Over Next 20 Years," *Bloomberg New Energy Finance*, November 16, 2011. <http://bnef.com/PressReleases/view/173>.
- <sup>67</sup> U.S. National Academy of Sciences, National Research Council. "Hidden Costs of Energy Use: Unpriced Consequences of Energy Production and Use," 2001, National Academy Press, Washington, DC, [http://www.nap.edu/catalog.php?record\\_id=12794](http://www.nap.edu/catalog.php?record_id=12794).
- <sup>68</sup> Dominici, F.; Greenstone, M.; and Sunstein, C.R. "Particulate Matter Matters." *Science* (344), 18 April 2014, pp.257-259.
- <sup>69</sup> Grahame, T. J.; Klemm, R.; Schlesinger, R. B. "Public Health and Components of Particulate Matter: The Changing Assessment of Black Carbon." Air & Waste Management Association, June 2014; pp. 41-47.
- <sup>70</sup> "Climate Change 2014 Synthesis Report." Geneva, Switzerland: Intergovernmental Panel on Climate Change. Available at: <https://www.ipcc.ch/report/ar5/>.
- <sup>71</sup> Melillo, J. M.; Richmond, T. C.; Yohe, G. W., eds. *Climate Change Impacts on the United States*, Washington, DC. U.S. Global Change Research Program, 2014. Available at: <http://www.globalchange.gov/what-we-do/assessment>.
- <sup>72</sup> Feldman, D. R.; Collins, W. D.; Gero, P. J.; Torn, M. S.; Mlawer, E. J.; Shippert, T. R. "Observational Determination of Surface Radiative Forcing by CO<sub>2</sub> from 2000 to 2010." *Nature* (519:7543), 2015; pp. 339-343.
- <sup>73</sup> Available at: <http://www.esrl.noaa.gov/gmd/ccgg/trends/>.
- <sup>74</sup> For a detailed review of the state of knowledge for climate change and its impacts, see the following:
- "Intergovernmental Panel on Climate Change Assessment Report 5 (IPCC AR5)." Available at: <https://www.ipcc.ch/report/ar5/>.
  - U.S. Global Change Research Program, U.S. National Climate Assessment. "Climate Change Impacts on the United States." 2014.
  - Zhao, T.; Dai, A. 2015. "The Magnitude and Causes of Global Drought Changes in the 21st Century Under a Low-moderate Emissions Scenario." *J. Climate*. DOI: <http://dx.doi.org/10.1175/JCLI-D-14-00363.1>, in press.
  - Cook, B. I.; Ault, T. R.; Smerdon, J. E. "Unprecedented 21st Century Drought Risk in the American Southwest and Central Plains." *Science Advances*, February 12, 2015.
- <sup>75</sup> Ocean acidification information can be found in the following:
- <http://www.interacademies.net/File.aspx?id=9075>.
  - <http://www.gfdl.noaa.gov/acidification> and <http://oceanacidification.noaa.gov/>.
  - <http://www.whoi.edu/oceanus/feature/the-socioeconomic-costs-of-ocean-acidification>.
  - Community Climate System Model 3.1 of the National Center for Atmospheric Research. Available at: <http://www.cesm.ucar.edu/models/ccsm4.0/>.
  - Feely, R. A.; Doney, S. C.; Cooley, S. R. "Ocean Acidification Due to Increasing Atmospheric Carbon Dioxide." The Royal Society. Policy document 12/05, June 2005. Available at: <http://www.royalsoc.ac.uk>.
- <sup>76</sup> "Annual Energy Outlook." EIA, DOE/EIA-0383, Washington, DC: U.S. Energy Information Administration, 2015. Available at: [http://www.eia.gov/forecasts/aeo/pdf/0383\(2015\).pdf](http://www.eia.gov/forecasts/aeo/pdf/0383(2015).pdf).

- <sup>77</sup> Rice, K. C.; Herman, J. S. "Acidification of Earth: An Assessment Across Mechanisms and Scales." *Applied Geochemistry* (27), 2012; pp. 1-14.
- <sup>78</sup> Llewellyn, G. T.; Dorman, F.; Westland, J. L.; Yoxtheimer, D.; Grieve, P.; Sowersc, T.; Humston-Fulmer, E.; Brantley, S. L. "Evaluating a Groundwater Supply Contamination Incident Attributed to Marcellus Shale Gas Development." *Proc. Nat. Acad. Sci.* Epub May 4, 2015.
- <sup>79</sup> Palmer, M. A.; Bernhardt, E. S.; Schlesinger, W. H.; Eshleman, K. N.; Foufoula-Georgiou, E.; Hendryx, M. S.; Lemly, A. D.; Likens, G. E.; Loucks, O. L.; Power, M. E.; White, P. S.; Wilcock, P. R. "Mountaintop Mining Consequences." *Science* (327:8), 2010; pp. 148-149.
- <sup>80</sup> Allred, B. W.; Smith, W. K.; Twidwell, D.; Haggerty, J. H.; Running, S. W.; Naugle, D. E.; Fuhlendorf, S. D. "Ecosystem Services Lost to Oil and Gas in North America." *Science* (348:6233), 2015; pp. 401-402.
- <sup>81</sup> Hand, M. M.; Baldwin, S.; DeMeo, E.; Reilly, J. M.; Mai, T.; Arent, D.; Porro, G.; Meshek, M.; Sandor, D., eds. *Renewable Electricity Futures Study*. 4 vols. NREL/TP-6A20-52409. Golden, CO: National Renewable Energy Laboratory, 2012. Available at: [http://www.nrel.gov/analysis/re\\_futures/](http://www.nrel.gov/analysis/re_futures/).
- <sup>82</sup> Hornbach, M. J.; DeShon, H. R.; Ellsworth, W. L.; Stump, B. W.; Hayward, C.; Frohlich, C.; Oldham, H. R.; Olson, J. E.; Magnani, M. B.; Brokaw, C.; Luetgert J. H. "Causal Factors for Seismicity Near Azle, Texas." *Nature Communications* (6:6728), 2015.
- <sup>83</sup> Witze, A. "Artificial Quakes Shake Oklahoma." *Nature* (520), April 22, 2015; pp. 418-419.
- <sup>84</sup> Petersen, M. D.; Mueller, C. S.; Moschetti, M. P.; Hoover, S. M.; Rubinstein, J. L.; Llenos, A. L.; Michael, A. J.; Ellsworth, W. L.; McGarr, A. F.; Holland, A. A.; Anderson, J. G. "Incorporating Induced Seismicity in the 2014 United States National Seismic Hazard Model—Results of 2014 Workshop and Sensitivity Studies." Report 2015-1070. Reston, VA: U.S. Geological Survey, 2015.
- <sup>85</sup> "Induced Seismicity." Lawrence Berkeley National Laboratory, 2015. [http://esd.lbl.gov/research/projects/induced\\_seismicity/egs/](http://esd.lbl.gov/research/projects/induced_seismicity/egs/).
- <sup>86</sup> "Annual Energy Outlook." EIA, OE/EIA-0383, Washington, DC: Energy Information Administration, 2014. Available at: [http://www.eia.gov/forecasts/aeo/pdf/0383\(2014\).pdf](http://www.eia.gov/forecasts/aeo/pdf/0383(2014).pdf).
- <sup>87</sup> DOE. "Quadrennial Energy Review: Energy Transmission, Storage, and Distribution Infrastructure." April 2015. Available at: <http://energy.gov/epsa/quadrennial-energy-review-qer>.
- <sup>88</sup> [http://www.eia.gov/dnav/pet/pet\\_pnp\\_cap1\\_dcu\\_nus\\_a.htm](http://www.eia.gov/dnav/pet/pet_pnp_cap1_dcu_nus_a.htm).
- <sup>89</sup> "Public Road and Street Mileage in the United States." U.S. Department of Transportation, Bureau of Transportation Statistics, 2015. Accessed August 6, 2015: [http://www.rita.dot.gov/bts/sites/rita.dot.gov/bts/files/publications/national\\_transportation\\_statistics/html/table\\_01\\_04.html](http://www.rita.dot.gov/bts/sites/rita.dot.gov/bts/files/publications/national_transportation_statistics/html/table_01_04.html).
- <sup>90</sup> "Freight Rail Today." U.S. Department of Transportation, Federal Railroad Administration, 2015. Accessed August 6, 2015: <https://www.fra.dot.gov/Page/P0362>.
- <sup>91</sup> U.S. energy infrastructure is examined in the "Quadrennial Energy Review." 2015, op cit. Available at: <http://energy.gov/epsa/quadrennial-energy-review-qer>.
- <sup>92</sup> "Commercial Buildings Energy Consumption Survey (CBECS)." U.S. Energy Information Administration, 2012. Accessed August 20, 2014: <http://www.eia.gov/consumption/commercial/reports/2012/preliminary/index.cfm>.
- <sup>93</sup> "Annual Energy Outlook." EIA, OE/EIA-0383. Washington, DC: Energy Information Administration, 2015. Available at: <http://www.eia.gov/forecasts/aeo/>.
- <sup>94</sup> Davis, S. C.; Diegel, S. W.; Boundy, R. G. *Transportation Energy Data Book*. Edition 33. ORNL-6990, Oak Ridge, TN: Oak Ridge National Laboratory, 2014. Available at: [http://cta.ornl.gov/data/teb33/Edition33\\_Full\\_Doc.pdf](http://cta.ornl.gov/data/teb33/Edition33_Full_Doc.pdf).
- <sup>95</sup> "Two Billion Cars: Transforming a Culture." *Transportation Research News* 259. Transportation Research Board, National Academy of Sciences (number 259), November–December, 2008; p. 3. Available at: <http://onlinepubs.trb.org/onlinepubs/trnews/trnews259.pdf>.
- <sup>96</sup> "Statistics of US Businesses (2011)." U.S. Census Bureau. Accessed November 3, 2014: [http://www2.census.gov/econ/susb/data/2011/us\\_6digitnaics\\_2011.xls](http://www2.census.gov/econ/susb/data/2011/us_6digitnaics_2011.xls).
- <sup>97</sup> "Energy Innovation to Meet a New Era of Challenges." American Energy Innovation Council, Bipartisan Policy Center, 2015.
- <sup>98</sup> American Energy Innovation Council, "Catalyzing American Ingenuity: The Role of Government in Energy Innovation", 2011, Figure 3, <http://americanenergyinnovation.org/>. The source data for the energy R&D portion of this figure is noted as coming from: Dooley, JJ. The Rise and Decline of U.S. Private Sector Investments in Energy R&D since the Arab Oil Embargo of 1973. Pacific Northwest National Laboratory, November 2010. Dooley notes difficulties with the survey methodology, which was conducted by the NSF across 20,000+ companies.
- <sup>99</sup> "Restoring American Energy Innovation Leadership: Report Card Challenges & Opportunities." American Energy Innovation Council, Bipartisan Policy Center, 2015. Available at: <http://www.americanenergyinnovation.org/wp-content/uploads/2015/02/AEIC-Restoring-American-Energy-Innovation-Leadership-2015.pdf>.
- <sup>100</sup> McNERNEY, J.; DoYNE Farmer, J.; Redner, S.; Trancik, J. E. "Role of Design Complexity in Technology Improvement." *Proc. Nat. Acad. Sci.* (108:22), 2011; pp. 9008-9013.
- <sup>101</sup> Nemet, G. F. 2006. "Beyond the Learning Curve: Factors Influencing Cost Reductions in Photovoltaics." *Energy Policy* (34), 2006; pp. 3218-3232.
- <sup>102</sup> Nagy, B.; DoYNE Farmer, J.; Bui, Q. M.; Trancik, J. E. "Statistical Basis for Predicting Technological Progress." *PLOS ONE* (8:2), February 2013; e52669.
- <sup>103</sup> President's Committee of Advisors on Science and Technology, Panel on Energy Research and Development. "Federal Energy Research and Development for the Challenges of the Twenty-First Century." Office of Science and Technology Policy, Executive Office of the President, November 1997. Available at: <https://www.whitehouse.gov/sites/default/files/microsites/ostp/pcast-nov2007.pdf>.



- <sup>104</sup> Bettencourt, L. M. A.; Trancik, J. E.; Kaur, J. "Determinants of the Pace of Global Innovation in Energy Technologies." *PLOS ONE* (8:10), 2013; pp 6.
- <sup>105</sup> Macher J. T.; Mowery, D. C., eds. *Innovation in Global Industries: U.S. Firms Competing in a New World*. Washington, DC: National Academies Press, 2008.
- <sup>106</sup> Wessner, C. W.; Wolff, A. W., eds. *Rising to the Challenge: U.S. Innovation Policy for the Global Economy*. Washington, DC: National Academies Press, 2012.





## Issues and RDD&D Opportunities

Energy systems are becoming increasingly interconnected and complex. Integrated energy systems present both opportunities for performance improvement as well as risks to operability and security. The size and scope of these opportunities and risks are just beginning to be understood.

This chapter addresses both the key issues of energy sectors and their associated energy systems and a spectrum of research, development, demonstration, and deployment (RDD&D) opportunities including energy systems integration and complex system science.

### Key issues:

- Three layers of increasing integration and complexity are discussed here:
  - Number, variability, and communication of devices connected to the electric grid
  - Cross-talk between sectors of the energy system (e.g., fuels/electricity, electricity/buildings)
  - Coupling of energy systems to non-energy systems (e.g., Internet, water)
- Information and communications technologies are driving the interconnection of energy systems.
- Integration can improve system cost and efficiency by optimizing the utilization of assets and resources.
- Integration can also increase the risks of unintended consequences and cascading failure.

### Opportunities:

- Identify and address market barriers to adopting integrated systems, including high capital costs and complexity of operations
- Develop methods of quantifying uncertainty in large energy systems and calculating networked risks
- Develop co-simulation models of the interdependencies between and among 1) energy system components, 2) energy and non-energy systems, 3) energy systems and human decision making, and 4) systems across extended time intervals between decisions and impacts
- Validate network and co-simulation models using real system data
- Apply complex network and complex system science to problems relevant to various energy sectors and their associated energy systems including the electric grid, transportation networks, and urban systems
- Develop operational strategies to manage complexity and optimize provision of energy services

# 2

## Energy Sectors and Systems

### 2.1 Introduction to Energy Systems

Some of the most transformational opportunities exist at the systems level. They are enabled by the ability to understand, predict, and control very large scale and interconnected complex systems. Systems solutions can be broadly impactful across multiple technologies and sectors.

Within and between the electric grid, power, buildings, manufacturing, fuels, and transportation sectors, increasing interconnectedness and complexity are creating opportunities and challenges that can be approached from a systems perspective. This chapter presents a holistic view of the energy system and explores the opportunities in energy systems research. Systems approaches can help to identify critical technology needs and can also be used to develop solutions to complex energy challenges.

Energy systems are also becoming more tightly intertwined with systems that are focused primarily on other services, such as information and communications technology (ICT) networks, transportation networks, food production, and financial systems. The increasing use of digital technology is driving these interconnections. Finally, energy systems also interact with large and complex natural systems, such as water supplies, air basins, ecosystems, and, at the largest level, the global climate system.

With increasing system size, and connectivity within and between systems, there are a growing number of opportunities for improved system performance as well as risks to system operability. In many cases, the size and scope of these opportunities and risks are just beginning to be quantified. For example, as discussed in this chapter and explored in greater detail in Chapter 3, as the complexity of the electric grid grows, the risk of cascading failure could begin to outstrip built-in protections and redundancies.<sup>1,2</sup> Quantifying and mitigating systemic risks through robust system design and operation could prevent billions of dollars of lost productivity.<sup>3</sup>

Each of the technology chapters (3–8) in this report describes energy systems that provide a desired set of end-use services. Instances of technological competition (e.g., heat pumps versus furnaces), cooperation (e.g., passive solar coupled to heating, ventilating, and air conditioning [HVAC] system downsizing), and consequences (e.g., displacing fossil fuel emissions at distributed sites with grid-supplied electricity) are examples of system interactions that drive the form and function of energy technologies presented in subsequent chapters. These system interactions play out within each step of the energy value chain—from energy resources, their conversion to fuels and electricity, through distribution networks, and in the end-use services provided in the residential, commercial, manufacturing, and transportation sectors.

Technologies with the potential to radically alter the structure of the energy system, either physically by switching energy carriers or virtually through market transformations, can be identified through applied systems analysis. One example is improved energy storage, which could drastically alter the delivery of energy services if it were cheap and light enough to broadly untether energy users from suppliers for extended periods. Another example is decentralized electricity systems, where responsibility for reliability and resilience might shift toward the edge of the network much like it is on the Internet. The effectiveness of these technologies can only be evaluated through a systems perspective.

### 2.1.1 Enabling Modernization of the Electric Power System (Chapter 3)

Chapter 3 views the grid as a critical platform for innovation, future energy markets, and services, and considers how that system's architecture and capabilities must evolve to meet the changing generation mix, customer role, and risk profile. The broad deployment of variable generation resources (most notably, solar and wind), distributed energy resources, energy storage, electric vehicles, and actively managed loads could substantially alter how the system will need to be designed, operated, and protected. At both the transmission and distribution levels, advances in information and communications technologies are being leveraged to enhance system visibility, understanding, and control to improve reliability and resilience. However, significant challenges with component technologies, systems integration, and institutional change must be addressed, including cyber- and physical security concerns across the entire system. These technologies and issues suggest the need for new system architectures, but any transformation must take place in the context of existing infrastructure assets, market structures, and institutions, and their associated pace of change.

### 2.1.2 Advancing Clean Electric Power Technologies (Chapter 4)

Chapter 4 addresses the production of electric power as an "options space" (for more information, see Chapter 10 *Concepts in Integrated Analysis*) where renewable, fossil, and nuclear resources compete to produce electricity. In producing clean electric power, there are interdependencies among base load, intermediate and peaking; variable and flexible; and central and distributed generators. The chapter considers the systems-level drivers (i.e., reliability, reserves requirements, environmental criteria, siting characteristics, and proximity to supply and transmission infrastructures) that must be balanced in assembling the generation mix. Systems-level issues also include portfolio diversification with respect to fuel supply, generator size, and technology maturity. The economies of scale required to deploy clean power, including U.S. and international market dynamics, add a temporal dimension to the systems-level considerations associated with these technologies.

### 2.1.3 Increasing Efficiency of Building Systems and Technologies (Chapter 5)

Chapter 5 considers buildings as integrated systems designed to deliver end-use services such as thermal comfort, air quality, lighting, hot water, sanitation, food preparation and storage, labor-saving conveniences, productivity, communications, and entertainment. Interactions among and between end-use services and efficiency technologies are analyzed in a systems framework that evaluates the cumulative impacts of staged technology implementation. Efficient technologies tend to diminish potential savings from subsequent deployment (e.g., efficient light bulbs reduce the energy savings potential of automatic lighting controls); therefore, it is imperative to understand total system impacts under a wide range of scenarios. Additionally, miscellaneous and plug-loads, which include a very large number of different device types, represent a target of growing importance, but are difficult to address at the individual-technology level. Integration of building energy systems with electricity and fuel supply systems must be considered. Finally, the long timescales over which buildings are operated demand an evaluation of retrofit options.

### 2.1.4 Innovating Clean Energy Technologies in Advanced Manufacturing (Chapter 6)

Chapter 6 views manufacturing as three nested opportunity spaces: 1) process technologies and unit operations are at the core, where innovations can both improve energy efficiency and enable new clean energy products; 2) facility systems are an intermediate level, where crosscutting and plant-level technologies impact the efficiency, sustainability and competitiveness of U.S. industrial concerns; and 3) beyond the plant boundaries is the outermost layer, where innovations in manufacturing affect the sustainability of supply chains along with the energy and life-cycle impacts of products that are manufactured as a part of the clean energy economy. The intermediate level explicitly engages systems integration issues within the manufacturing plant by considering



global optimization of material and heat flows, and integration with energy supply systems. Advanced process technologies, however, may also have system-wide impacts (e.g., supply chain impacts of additive manufacturing). A major systems-level challenge for advanced manufacturing technologies is measuring their full energy, security, cost, and environmental impacts (via life-cycle assessment or similar approaches).

### 2.1.5 Advancing Systems and Technologies to Produce Cleaner Fuels (Chapter 7)

Chapter 7 considers three primary fuel pathways: 1) fossil liquids and natural gas, 2) biomass, and 3) hydrogen. It examines the RDD&D opportunities for each pathway across the fuel value chain—resources for producing fuels, upgrade and transport, conversion and synthesis, distribution, and compatibility with end uses. Environmental concerns (e.g., greenhouse gas [GHG] emissions, land use, water use, etc.) are addressed at all stages of the value chain. This value chain depends on an extensive network of wells, farms, pipelines, refineries, terminals and distribution stations. At the systems-level, advanced technologies must be developed and deployed along a pathway that considers compatibility with infrastructure and vehicles. The potential co-production of fuels, electricity and/or heat from coal, gas and/or biomass (potentially with carbon capture and storage [CCS]) also presents a systems integration issue. Finally, responsible fuels production from biomass, as well as from hydraulically fractured oil and gas wells, requires mitigating energy-water systems issues.

### 2.1.6 Advancing Clean Transportation and Vehicle Systems and Technologies (Chapter 8)

Chapter 8 takes an impact analysis approach to the transportation system, evaluating the potential for technologies at various maturity levels to reduce GHG emissions. Considered are the following: improvements to combustion-powered vehicles; development of plug-in electric vehicles; pathways to enable hydrogen fuel cell vehicles; information-enabled transformation of personal and freight transportation systems; and improvements to other modes of transit such as aviation, ship, rail, and pipeline. At the single-vehicle level, efficiency, safety, and lightweighting improvements can be mutually reinforcing, and the compound benefits can only be evaluated in a systems framework. Integration of vehicle technologies with energy delivery infrastructures (biofuels, electricity, hydrogen) is a systems issue that could limit or accelerate the impacts of advanced technologies. Finally, systems developments that change the paradigm of personal vehicle control and/or ownership (connected and automated vehicles, shared vehicles) may drastically alter patterns of transportation energy use with unforeseen consequences.

### 2.1.7 Sector Cross-Connections

In addition to the systems view of the technology space covered by each chapter, there are systems interactions between and among the technologies covered in separate chapters. For example, technologies that enable better hydrogen storage onboard vehicles are explored in Chapter 8 (*Transportation*), while the benefits of those technologies can only be realized through the production of hydrogen, which is described in Chapter 7 (*Fuels*). When dividing the energy space into sectors, such overlaps are inevitable. However, there are other cases where the overlaps between chapters are intrinsic to the technology and not the report structure. In the case of GHG emissions management, a suite of technologies will need to be tailored to specific applications within the power sector (including coal and gas-fired generators), the industrial sector (including cement, steel, ethanol, and other large point sources of carbon dioxide [CO<sub>2</sub>]), as well as to offset use of fossil fuels in distributed applications too small for CCS (e.g., by using instead electricity or zero-carbon fuels).

Ways to address these crosscutting themes are explored in the *Conclusion* (Chapter 11). A table of crosscutting technologies and description of related themes, as well as the affected sectors, is included in Table 2.1 at the end of this chapter.

## Cybersecurity

Information and communications technologies (ICT) are enabling significant improvements in the performance and efficiency of many energy systems. However, transferring data in and out of energy systems relies on wireless and/or Internet-connected communications channels, which form an attack surface for cyber intrusion. Many of the facets of security for the electric grid are explicitly addressed in Chapter 3. The magnitude of the cyber threat extends well beyond the grid, as described below.

- The entire fuels production and distribution value chain—from subsurface instrumentation or automated farming equipment; to the supervisory control and data acquisition (SCADA) systems at oil- and bio-refineries; to pipeline, rail, and truck distribution networks—are increasingly computer controlled and subject to cyber attack.
- Power plants are at the nexus of electricity, water, and fuels networks. Their control systems form a virtual link between these critical infrastructures, each of which is subject to cyber attack.
- Communications networks in buildings, which are increasingly accessible to wireless and remote monitoring and control, are a growing cybersecurity and privacy concern. Security concerns are particularly important in hospitals and other sites where life and safety are at risk.
- As control of manufacturing systems evolves from (relatively) localized SCADA to more broadly networked smart manufacturing platforms that integrate with supply network coordination frameworks, the potential for cyber intrusion is growing.<sup>4</sup>
- Automated and connected vehicles have multiple network intrusion points and represent a safety-critical cyber risk. Hacking of single-vehicle networks through wireless sensors has been publicly demonstrated.

Challenges for addressing the energy systems' cyber vulnerabilities include the following:

- Rigorous application of cybersecurity best practices (e.g., encryption, firewalls, and unidirectional gateways) on energy ICT systems
- Tools to measure the maturity, security, and resilience of ICT-enabled energy systems and networks
- Situational awareness of small- and large-scale cyber attacks on connected and embedded systems with integrated forensics and coordinated rapid incident response
- Design of self-configuring systems adaptable to a variety of network architectures, including transition to, and operation in, an island mode in order to mitigate the spread and impact of a cyber attack
- Maintenance and update of software in embedded low-cost devices to address evolving security vulnerabilities
- Legacy ICT systems in energy system components that may have multidecade service lives
- Supply chain integrity of the components that, once assembled, form the systems used for data acquisition, command, and control of energy infrastructure
- Qualified and trained workforce that focuses on the unique cybersecurity requirements of energy devices and networks that are fundamentally different from traditional information technology services

## 2.2 Energy Systems Integration

Energy systems are becoming increasingly interconnected to each other as well as to other systems that have, until recently, been analyzed largely in isolation. Feedbacks between energy and ICT systems are an obvious example, but it is also recognized that energy systems are becoming more tightly coupled to water resources, raw and finished material supply chains, agricultural systems, patterns of land use, and energy-related financial systems. This section explores the research, development, demonstration, and deployment (RDD&D) opportunities associated with integrating systems at multiple scales, the failure modes associated with integrated systems, and the potential benefits and risks that this integration entails.

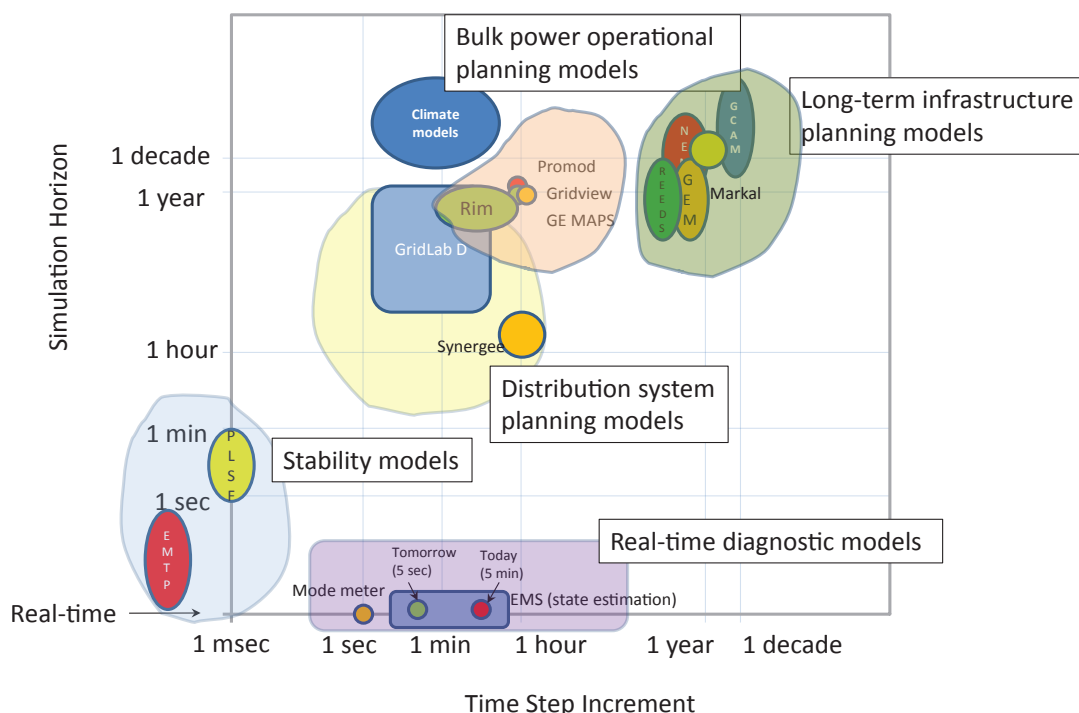
Potential benefits of integrated systems include efficiency, resource savings (money, time, energy), reduced GHG emissions, and increased resiliency. For example, the water savings from energy-saving programs in Arizona could reduce non-agricultural water use from 2% to 15%, while water conservation policies could also reduce statewide electricity use from 1% to 3%.<sup>5</sup> It has also been argued that integration of different energy systems (e.g., electricity, natural gas, petroleum, biofuels, and transportation) can minimize disruption from natural or human-caused events by increasing connectivity throughout the energy system.<sup>6</sup>

However, there are also challenges and risks associated with systems integration. Integrated systems can create bottlenecks and single points of failure for multiple systems. Moreover, the economic efficiency of integrated energy systems may conflict with flexibility requirements. Mitigating these risks becomes especially challenging when market drivers push systems integration faster than regulations, institutions, and planning processes

**Figure 2.1** Multiple Scales of the Integrated Electrical System. Note: “simulation horizon” indicates the length of time that the model simulates, whereas “time step” indicates the increment or resolution of the model. Colored patches indicate the ranges across which different models, indicated by their acronyms, operate. Certain areas are not addressed by these models, and furthermore, these models are often unable to easily communicate with each other.

Credit: Michael Kintner-Meyer, Pacific Northwest National Laboratory

### Landscape of Electricity Infrastructure models



evolve. For example, gas use for electricity generation is increasing rapidly despite ongoing coordination challenges between electricity and gas markets. Timely research on integrated energy system architectures and planning will smooth these technology and institutional transitions.

Appropriate application of systems integration requires understanding, control, and optimization across multiple sectors (e.g., fuels, power, buildings, and water), time frames (from fractions of a second for operations to years for planning), spatial scales (devices, buildings, campuses, city, region/state, nation), and functions (e.g., data, analysis, controls, and markets). Integration also requires an understanding of costs, particularly the capital costs of deploying new and/or integrative technologies, but also the financial implications of deployment and operations. An example (see Figure 2.1) is the electric grid, where timescales span from milliseconds to decades, and where existing modeling frameworks span only subsets of this space. Changes at one scale may impact other scales that cannot be predicted in the current simulation paradigm. Research is needed on basic and applied systems science, data, architectures, computational analysis, communications, and control. The results of such research could help system designers and operators to optimize the operations of interconnected systems with appropriate risk mitigation, including such strategies as appropriate system sizing and graceful disconnection.

### 2.2.1 Systems of Systems

There is potential to enhance performance of large, integrated systems by improving communications between sub-systems and by improving the overall structure of the system so as to reduce the likelihood of operations that are locally optimal but globally sub-optimal.

Examples of cross-system interactions are highly varied and include the following:

- Electric vehicles (EV) and distributed solar generation are penetrating deeply in some neighborhoods and scarcely at all in others. Neighborhood social networks (e.g., local observation, word-of-mouth, and peer pressure) combine with geo-localization of socioeconomic conditions to drive this uneven adoption of energy technology. That adoption pattern, in turn, drives uneven requirements for equipment on the electrical distribution grid. Social and decision science research can help inform photovoltaic (PV) and EV grid integration requirements.
- The fuel supply is a system of systems at the largest scale. For instance, the expansion of domestic oil extraction from the Bakken and Eagle Ford shales and the increased use of ethanol-blended gasoline at the 10% level are increasing the amount of fuel being shipped by rail across the United States. Petroleum fuels and ethanol, which have two entirely separate production systems, first compete for space in the rail transportation system and then are blended at refineries and terminals and sold as a single product.
- Energy systems are becoming increasingly reliant on the ICT systems that now span the entire globe in the form of the Internet. ICT systems, in turn, have always been dependent on electrical power (critical ICT infrastructure, for example, usually incorporates backup power). Advanced ICT capabilities enable more sophisticated algorithms for managing energy systems and more diverse energy systems (e.g., building, campus, regional, national) to communicate with one another. On the other hand, ICT also opens a wide range of new risks from the inherent issues of complex system dynamics to cyber vulnerabilities.

### 2.2.2 Interdependency

Tight coupling of otherwise independent systems can simultaneously increase redundancies and the risk of catastrophic, multisystem failure.<sup>7,8</sup>

Coupled energy-ICT systems are becoming more commonplace. In the electricity sector, smart meter and synchrophasor data are just beginning to affect near-term markets that are already deeply digitized, simulation-based, and forecast-dependent. The energy-water nexus has become a well-documented case of dependent

coupled systems—electricity generation requires water for cooling, while moving and treating water requires electricity.<sup>9</sup> It is critical to understand how each “half” of the coupled system is affected when performance of the other half is degraded. The propagation speed of disturbances and “tipping points” into catastrophic failure depend on the nature of connectivity within and between systems.

Energy systems are also coupled to weather. In hot weather, thermal cooling is less effective, resulting in the de-rating of power plants. Also during hot weather, demand for electricity-based air conditioning increases. However, high-voltage transmission lines experience temperature-induced sagging, so the capacity of such lines must be reduced to avoid contact with trees or structures. These events occur at the same time, all of which result in a strain on electricity generation systems. Droughts also affect energy systems. Shortages of water and water intake and outlet temperature limitations can constrain cooling of thermal power plants or reduce hydrological resources. Droughts also affect biomass production.<sup>10</sup> Cold weather increases demand for building heating, placing a strain on energy delivery systems, while ice and snow can cause problems for wind turbines, solar cells, power lines, and fuel delivery by truck or rail. It is also well known that electricity grids often fail during storms due to downed power lines, lightning strikes, and flooding.

In a feedback loop with many unknown parameters, emissions of GHGs from the use of fossil energy are driving changes in the climate. These changes have implications of higher variability and uncertainty in weather patterns and extreme weather events. The long-term coupling of energy systems, and climate, and therefore with weather is clear, and research is ongoing to better quantify the timing, localization and severity of impacts. A fundamental understanding of the energy system’s impacts on climate and improved understanding of the climate’s impacts on energy systems, together with evaluation of mitigation and adaptation strategies, will reduce the risks associated with this interdependency.

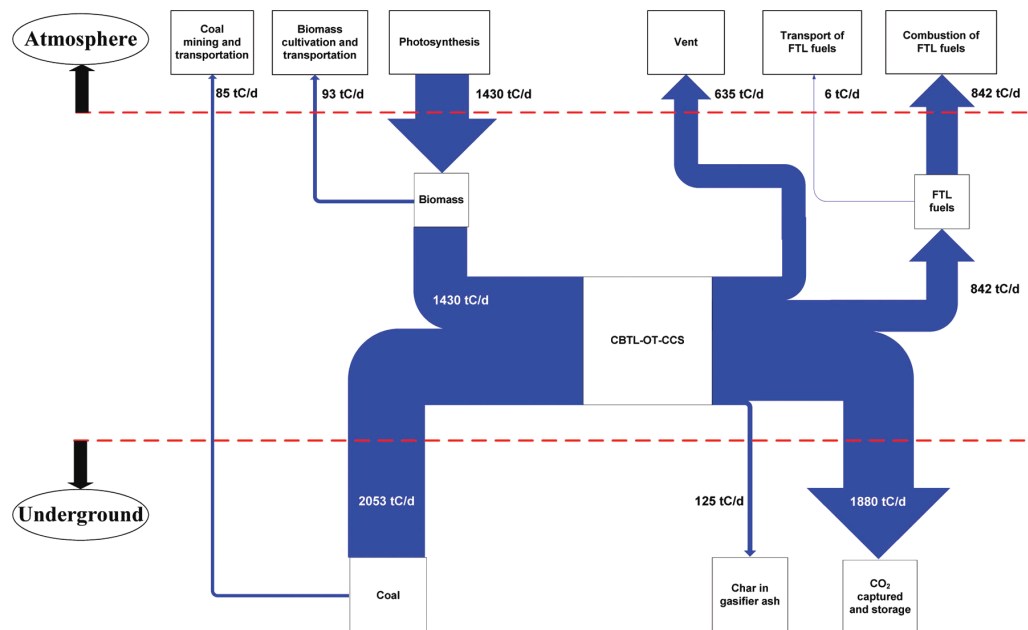
### 2.2.3 Hybrid Systems

Hybrid energy systems can improve overall energy efficiency by combining multiple inputs and/or outputs, or using waste from one system as input to another. Examples include combined heat and power in buildings and manufacturing; polygeneration of electricity and fuels, chemicals or fresh water; and hybrid systems that combine nuclear with renewables, or co-fire coal and biomass (potentially with CCS). With respect to the consumer, examples include hybrid space<sup>11</sup> and/or water<sup>12</sup> heating, solar PV and/or thermal heating,<sup>13</sup> daylight/task lighting systems,<sup>14</sup> and combination appliances<sup>15</sup> or electronics.<sup>16</sup>

One example of a dual-fuel, polygeneration hybrid system that has received significant attention for its potential to mitigate GHG emissions is combining coal and biomass to produce liquid fuels and electricity with CCS (CBTLE-CCS), as illustrated in Figure 2.2. There are several ways in which such a system could be configured, but the underlying principle is to integrate the heat and mass flows of 1) a gasification and Fischer-Tropsch fuel synthesis plant with 2) a combined-cycle cogenerating electricity plant. Depending on the ratios of biomass-to-coal in the plant inputs and fuels-to-electricity in the plant outputs, the net carbon emissions of the polygeneration system (including the CO<sub>2</sub> from the fuel it produces) could be positive, negative or zero. Assuming the system displaces electricity that would otherwise have been generated by a carbon-emitting power plant, the net environmental benefits could be significant. Detailed cost and energy analysis down to the equipment level shows the cost and performance benefits of an integrated system over separate fuels- and power-production systems competing in the same markets.<sup>17</sup> Scenario analysis has shown that such carbon-negative systems are important options for achieving global emissions goals.<sup>18</sup> Chapter 7 Section 7.5.3 provides further details, describes challenges, and notes overarching RDD&D needs.

**Figure 2.2** Potentially Net-Negative Carbon Flows in a Hybrid Polygeneration CBTLE-CCS System

Credit: Reprinted (adapted) with permission from Guangjian Liu, Eric D. Larson, Robert H. Williams, Thomas G. Kreutz, and Xiangbo Guo. "Making Fischer-Tropsch Fuels and Electricity from Coal and Biomass: Performance and Cost Analysis." *Energy & Fuels* 25 (1), 415-437. Copyright (2011) American Chemical Society.



## 2.2.4 Research Needs

Integrated systems present a variety of challenges that cannot be met by studying component systems in isolation. Potential research pathways include the following:<sup>19</sup>

- Expanding knowledge of global interdependencies among networks of different types<sup>20</sup>
- Identifying trade-offs among multiple objectives
- Quantifying uncertainties, developing robust solutions that hold up under uncertainty, and developing methods of identifying and quantifying networked risk and uncertainty
- Identifying and addressing market barriers to adopting integrated systems, including high capital costs as well as the complexity hurdles that prevent adoption even when there is clear financial payback
- Advancing the science of integrated system design to manage risks associated with the introduction of new components and interactions
- Co-simulation modeling of the interdependencies between and among 1) energy system components; 2) energy and non-energy systems; 3) energy systems and human decision making, including operator and consumer behavior; and 4) systems across extended time intervals between decisions and impacts
- Close integration of theory and computation with empirical and experimental efforts, including game theory, laboratory and Web-based experiments, agent modeling, and data mining
- Model validation using real system data (energy system data must be curated, cleaned, and sanitized for privacy and made available to researchers)
- Performing scenario analysis on potential future energy systems that are radically different from today's systems due to significant uptake of architecture-altering technologies (e.g., local energy storage and decentralized electricity systems)

## 2.3 Complex Systems and Networks

As complexity and interconnectedness within the energy system grow, the difficulty of characterizing the system increases. Examples of systems exhibiting growth in complexity include transportation networks, urban infrastructures, and the electric grid. Advances in the operation, planning, modeling, and simulation of complex systems<sup>21</sup> are being actively pursued.<sup>22</sup> In some cases, the science of complex systems may enable the prediction and subsequent control of some macroscopic properties and behaviors, including disruptions, that emerge from system interconnectedness.

Complex systems are multicomponent, multidomain, multiscale, and/or multidimensional, and can be difficult to fully characterize.<sup>23</sup> Literature from the discipline of formal “complex systems science”<sup>24</sup> defines a subset of systems that are impossible to fully characterize because of a large number of nonlinear interactions between sub-components. In these inherently multiscale systems, emergent properties or behaviors can only be predicted and managed from a systems perspective.

There are a number of warnings from complex systems scientists who argue that increased interdependence, and the complexity it brings, may increase vulnerability rather than reducing it.<sup>25</sup> It has been demonstrated<sup>26</sup> that interconnected networks can fail more easily precisely because they can propagate failures more rapidly and thoroughly than isolated systems. Such systems can result in “uncontrollable situations even when decision makers are well-skilled, have all data and technology at their disposal, and do their best.”<sup>27</sup> Researchers find that interconnected networks can sometimes lead to outcomes that are opposite those found in isolated networks, indicating that predictions or experience based on simple systems may be fundamentally flawed when it comes to complex interconnected systems. Redundancy—a fundamental tool to guard against catastrophic failure—is often reduced in interconnected systems in an attempt to be more efficient.<sup>28</sup>

Potential remedies to the vulnerabilities of complex systems include limiting connections between systems, slowing the speed of propagation by introducing virtual “friction” when needed, allowing coordination to exist locally but perhaps not globally and by the design of the network hubs and their interconnections.<sup>29</sup> More research is also needed—in many cases simply to explore and prepare for, contingencies normally considered outside the realm of possibility. This is because state distributions in interconnected systems are often highly correlated, related in nonlinear ways, and extreme risks are often poorly characterized. Models that capture the important components of a complex system are vital. Approaches include: 1) more comprehensive models that capture all known detail and sample the full range of the distribution space, and 2) holistic models that reveal and characterize emergent system behavior at the expense of detail.

### 2.3.1 Electric Power System

The electric power system is unambiguously complex, and the research community is working to propose and validate formal complex network models of the electric grid to inform and support its evolution.

The electric grid is evolving from a twentieth century model of largely centralized, controllable generators and distributed, independently controlled loads to one with a potentially much larger number of distributed, variable generators and participatory, coordinated loads. The current system is a stable one, even though it is quite complicated with respect to the number of devices connected to it. The number of agents that could affect the state of the system was limited; the variability of energy input to the system was small; and many of the largest loads intrinsically reduced consumption in response to a drop in system frequency. For any given area, a handful of generators and control devices could reliably maintain frequency and voltage. Architectures and control systems were designed with sufficient margin such that disruptive events (i.e., loss of a generator, loss of load) could be swiftly isolated and remedied, thereby avoiding cascading failure.

New and increasingly affordable technologies are changing this landscape. Both the number of agents on the supply side and the connectivity between agents of all types are rapidly increasing. Distributed generation, capable of offsetting local power needs and occasionally selling excess power into the broader market, is becoming an attractive investment option. Feedbacks, with widely varying time delays, are being established between pricing authorities (i.e., utilities) and consumers through the implementation of demand-side management and dynamic pricing. Rapid deployment of utility-scale wind generation and utility-, commercial-, and residential-scale solar generators is increasing the fluctuations of energy inputs to the grid. An additional layer of connectivity arises from the deployment of new monitoring, communication, and controls.

Each of these developments is beneficial in support of a specific goal. Distributed generation can both leverage a near-term market opportunity and increase local resilience to distribution-level (and possibly transmission-level) outages. Dynamic pricing can drive more consistent economic efficiency of the entire electric system. Demand response programs can avoid costly capital expansion with minimal economic risk. And variable renewable electricity sources can offset GHG emissions. However, each of these technologies adds complexity to the system. When viewed from a holistic systems perspective, these developments may have detrimental impacts by adding fluctuations, feedbacks, and connectivity along which failure can propagate. Conversely, they may also strengthen the system through increased diversity, agility, and flexibility.

Approaches to managing the complexity that these clean energy technologies bring include the following:

- Develop, verify, and validate complex system and network models and simulations
- Identify operating modes and interactions among technologies that increase the risk of failures and outages, as well as those which reduce these risks
- Develop strategies to mitigate risks with currently available tools and architectures
- Conduct R&D on complex systems to identify novel architectures that fundamentally increase reliability and resilience
- Conduct demonstrations and facilitate the deployment of technologies that further validate successful integration into the electric power system

There is a continuing need for basic understanding of the complicated physics and engineering of the current and future electric grid. Combining basic and applied science with power systems engineering will enable improved understanding and control of the complex phenomena occurring on the electric grid.

There are already significant research collaborations underway between and among energy systems domain scientists, complicated systems simulation experts, and complex systems researchers. The Multifaceted Mathematics for Complex Energy Systems (M2ACS) project<sup>30</sup> is one example of such collaboration. Under this collaboration, electrical engineers and computer scientists from universities and DOE's national laboratories are developing algorithms to more effectively simulate the operation of very large electricity networks on high-performance computers, to leverage patterns of complexity in the electrical system to generate better predictive models, and to better predict cascading failures in short intervals.

Simulation of systems as large as the U.S. electric power system with high spatial and temporal resolution can quickly surpass current modeling capabilities and computing speeds. However, as simulation skill and capability develops, there will be increasing opportunities to identify improved architectures, strategies, and control systems that meet emerging needs while maintaining stability.



### 2.3.2 Transportation Networks

Networks of roads, rails, waterways, and airports on which hundreds of millions of vehicles travel, facilitate movement of people and cargo on billions of trips across trillions of miles each year in the United States. Complex systems analysis techniques are already in use, analyzing traffic patterns and helping to optimize shipments of freight. For example, information about traffic (via the sight-lines of drivers) has historically propagated locally over very short distances. The interactions between vehicles (via control inputs of steering, acceleration, and braking) have occurred on human-actionable timescales. These highly localized and relatively slow interactions give rise to macroscopic patterns of traffic congestion that cannot be predicted with models of traffic as a simple continuum flow. Rather, more intricate models of vehicle interaction are required, and their application results in far more accurate simulations.<sup>31</sup>

Today, a new layer of complexity is emerging in the transportation system—autonomous and connected vehicles. Much like the new layers of complexity that are affecting the performance of the electric grid, these vehicles stand to benefit the entire transportation system. Well-designed smart vehicle systems may reduce traffic fatalities, reduce traffic congestion and optimize drive cycles for greater efficiency. They may also reduce capital costs if transportation is delivered as a service that replaces traditional vehicle ownership.

Connected and autonomous vehicles likely will receive traffic and routing information from the Internet based on local and wide-area congestion conditions. The vehicles may engage in local vehicle-to-vehicle communications of position, velocity, acceleration, and “intent”<sup>32</sup> that would increase both safety (collision avoidance)<sup>33</sup> and efficiency (“platooning”).<sup>34</sup> Autonomous vehicles likely will function in much the same way that traditional vehicles do—applying control inputs in response to visible (e.g., camera, radar) cues in the local environment, but at a much increased response rate compared to their human counterparts.<sup>35</sup> These local and global interactions are likely to give rise to new macroscopic traffic phenomena. Designers and operators of such systems will need to leave room for the networks to evolve with behaviors that improve the safety and efficiency transportation beyond what is initially envisioned. The impacts of these new transportation technologies on energy use, however, are unknown and range from improved efficiency reducing energy use to increased trips resulting in increased energy use.

### 2.3.3 Urban Systems

Cities are complex, multiscale, adaptive systems whose most important feature is their population density.<sup>36</sup> Cities also are manifestations of densely packed interdependent infrastructure networks. These networks include not only energy (electricity, gas, and liquid fuel) supply and distribution, but also water supply and sanitation, communications, public and private transportation, food distribution and service, health care delivery, and emergency services.

While humans, with limited and error-prone decision-making abilities, are the most unreliable component of the network, they also are the best able to adapt and recover from off-normal conditions.<sup>37</sup> Technologies that assist urban citizens to optimize energy use, minimize environmental damage, and avoid and/or recover quickly from emergency conditions are of increasing interest.

In urban systems, multiple infrastructures interact on multiple timescales, from minutes (in the case of emergency response) to decades (in the case of infrastructure planning). Incorporating energy, end-use services, and the environmental consequences of energy consumption into the complex system models that support urban operations and planning is a relatively new endeavor. Institutes such as the Center for Urban Science and Progress at New York University<sup>38</sup> are finding ways to improve urban systems simulation with the massive amounts of data that are newly available from the information technologies rapidly penetrating the consumer, commercial, and municipal markets.

## 2.4 Conclusion

The energy economy is a deeply nested and interconnected system of systems. The six chapters that follow—**Grid, Power, Buildings, Manufacturing, Fuels, and Transportation**—are the first layer of a set of organizing principles for assessing energy technology RDD&D opportunities.

The opportunities for systems research within each chapter can be broken down into two overlapping classes: 1) energy systems integration, and 2) complex systems and networks. This chapter has briefly surveyed these opportunities. The subsequent chapters will examine the opportunities in the context of specific technology advances that can affect the overall energy system.

**Table 2.1** Crosscutting Technology Table

Crosscutting theme description	Crosscutting technology	Sectors affected
<p><b>Grid Modernization</b> describes the transition from a centrally-controlled, system with one-way power flows in distribution to a much more distributed, stochastic, and dynamic system with bi-directional flows in distribution. Growth in the deployment of variable generation, electronic converters, and digital communications and control technologies is impacting core characteristics of the electricity system. Grid-related technologies need to evolve with the changing supply and end-use technologies landscape. Simultaneously, the RDD&amp;D associated with technologies that connect to the grid (e.g., renewable power supplies, efficient motor controllers, electric vehicles, and smart loads) should consider the evolving interface with the grid.</p>	Microgrids	<b>Grid, Buildings, Manufacturing</b>
	Demand response and dynamic pricing	<b>Grid, Buildings, Manufacturing, Transportation</b>
	Distributed generation	<b>Grid, Buildings, Manufacturing, Power</b>
	Physical and synthetic inertia	<b>Grid, Power</b>
	Generation flexibility	
	Electric vehicles	<b>Transportation, Grid</b>
	Power electronics	<b>Manufacturing, Grid, Buildings, Power, Transportation</b>
<p><b>Systems integration</b> recognizes that energy systems are becoming increasingly interconnected to each other as well as to other systems such as water systems and material supply chains. Potential benefits of integrated systems include efficiency, resource savings, reduced GHG emissions and increased resiliency. There are also challenges and risks associated with systems integration such as potential bottlenecks and points of failure. Appropriate application of systems integration requires understanding, control, and optimization across multiple sectors (e.g., fuels, power, thermal, and water), time frames (fractions of a second for operations to years for planning), spatial scales (devices, buildings, campuses, city, region/state, nation), and functions (e.g., data, analysis, controls, and markets). Integration also requires an understanding of costs, particularly the capital costs of deploying new and/or integrative technologies, but also the financial implications of deployment and operations. Integration of technologies such as fuel cells, energy storage, rooftop solar, and microgrids will all be affected by systems integration strategies. The results of such research could help system designers and operators to optimize the operations of interconnected systems with appropriate risk mitigation, including such strategies as appropriate system sizing and graceful disconnection.</p>	Polygeneration	<b>Fuels, Power</b>
	Hybrid generation	<b>Power</b>
	CO <sub>2</sub> as a working fluid	
	Combined heat and power	<b>Manufacturing, Power, Buildings</b>
	Waste heat recovery	<b>Manufacturing, Buildings, Transportation, Power</b>
	Carbon management	<b>Power, Manufacturing</b>

**Table 2.1** Crosscutting Technology Table (continued)

Crosscutting theme description	Crosscutting technology	Sectors affected
<p><b>Cybersecurity</b> is essential to the increased use of ICT in modernizing energy systems. The proliferation of computer controlled, wireless and/or Internet-connected energy devices creates a growing attack surface for cyber intrusion. Cybersecurity is being actively investigated for the electricity system, but is also a concern for SCADA hardware and evolving smart and connected systems that control fuels production, power generation, building energy use, and manufacturing facilities. It will also be increasingly important to automated and connected vehicles in the transportation sector.</p>	Cybersecurity	<b>Grid, Power, Buildings, Manufacturing, Transportation, Fuels</b>
<p><b>The energy-water nexus</b> describes the water demands of energy extraction and conversions, and the energy demand of supplying fresh water and managing wastewater. In the fuels sector, the water injected into, and returned from, hydraulically fractured oil and gas wells and the irrigation water required to produce biofuel crops are the primary energy-water concerns. In the power sector, water used for cooling thermal power plants (coal, gas combined cycle, nuclear, etc.) is the largest category of water withdrawal in many regions. Process and cooling water is also a critical resource in energy-intensive industries, and the energy used to supply water to agricultural, residential, and manufacturing consumers is a significant percentage of total energy demand in some locations.</p>	Produced water management	<b>Fuels</b>
	Agricultural best practices	
	Low-water and dry cooling	<b>Power, Manufacturing</b>
	Process intensification	<b>Manufacturing, Fuels, Power, Buildings</b>
	Energy harvesting from wastewater	<b>Manufacturing</b> (also Municipal Systems)
<p><b>Subsurface science and technology</b> enables understanding and control of fracture, fluid flow, and chemistry in underground rock formations. Because most phenomena in the subsurface cannot be observed directly, significant advances in remote sensing and simulation are required to advance the state of the art. Similarly, because subsurface environments are often hot, highly pressurized and remote, advancements in well drilling, completion, and fluids management can make subsurface energy operations more safe, environmentally responsible, and cost effective. In addition to oil and gas, enhanced subsurface science and technology addresses: 1) geothermal energy, which requires maintenance (and sometimes creation) of networks of underground fractures in hot rocks; 2) carbon dioxide sequestration, which requires flow and caprock seal assurance, as well as characterization of potential storage reservoirs; and 3) nuclear waste disposal in a geologic repository, which requires multi-thousand-year simulations to ensure that future generations will be protected.</p>	Drilling and completion	<b>Fuels, Power</b>
	Fracture mechanics	
	Advanced proppants	
	Multi-physics porous media flow simulation	
	New subsurface signals	



**Table 2.1** Crosscutting Technology Table (continued)

Crosscutting theme description	Crosscutting technology	Sectors affected
<p><b>Materials</b> influence the performance and cost of nearly all energy technologies. Development of materials is application specific. Identification, development, and production of advanced materials is a substantial enabling science, engineering, and manufacturing challenge. R&amp;D activities on critical materials crosscut the power and transportation sectors (permanent magnet motor/generators) and the buildings sector (phosphors for lighting). Wide bandgap semiconductors are applicable to the grid, power, manufacturing, buildings, and transportation sectors. Functional materials such as membranes, catalysts and photovoltaics have a similarly broad reach, including advanced fuels production. Strong and lightweight materials are critical to transportation system efficiency. Materials for harsh service conditions are engineered to variously withstand high pressure, high temperature, corrosive environments, and radiation in boilers for applications in the power sector and downhole environments in the fuels sector.</p>	Critical materials	<b>Manufacturing,</b> Power, Buildings, Transportation
	Wide bandgap semiconductors	<b>Manufacturing,</b> Grid, Power, Buildings, Transportation
	Functional materials	<b>Manufacturing,</b> Fuels, Power, Buildings
	Lightweight materials	<b>Transportation,</b> Manufacturing, Power
	Materials for harsh service conditions	<b>Manufacturing,</b> Fuels, Power, Transportation
	Working fluids	<b>Buildings,</b> Power, Manufacturing
	Additive manufacturing	<b>Manufacturing,</b> Power, Transportation
	Roll to roll manufacturing	<b>Manufacturing,</b> Power, Buildings, Transportation
<p><b>Fuel-engine co-optimization.</b> Engine performance, which drives efficiency across the entire transportation fleet, can be limited by the properties of the fuels available. With bio-derived, and/or other synthetic fuels, there is an opportunity to optimize the end-to-end fuel-vehicle system for improved efficiency and reduced environmental impacts. Engines that take advantage of the special properties of appropriately engineered fuels may be able to operate at higher compression ratios and under alternate combustion regimes (homogeneous or partly stratified charge). Similarly, fuels derived from non-petroleum feedstocks can be formulated for use in advanced technology engines. A co-optimized fuel and engine system therefore has the potential to improve fleet-scale efficiency and reduce vehicle GHG emissions. Fuels derived from low, zero or negative-carbon feedstocks and processes will result in further emission reductions. Foundational science and technology research that crosscuts the fuels and transport sectors is required to achieve these goals.</p>	Combustion	<b>Transportation,</b> Fuels, Manufacturing
	Fuel design	<b>Fuels,</b> Transportation

**Table 2.1** Crosscutting Technology Table (continued)

Crosscutting theme description	Crosscutting technology	Sectors affected
<p><b>Energy storage</b> is important to a modernized electric grid, and also for electric vehicles, albeit with vastly different requirements. Flexible, low-cost, high round-trip-efficiency storage technologies can provide short term (frequency support) and long-term (firming, arbitrage) services to the electricity system. Alternatives to hydrocarbon fuels such as hydrogen and batteries are under investigation for electric vehicles. Fundamental research on development and manufacturing of efficient, durable, low-cost, high energy-density storage could enable transformational change across multiple sectors.</p>	Batteries	<b>Transportation</b> , Grid, Manufacturing
	Hydrogen	<b>Fuels</b> , Transportation, Manufacturing, Power, Grid
	Thermal storage	<b>Power</b> , Grid, Buildings
	Flywheels	<b>Grid</b> , Transportation
	Pumped hydro, compressed air energy storage	<b>Grid</b> , Power
<p><b>Computational modeling and simulation</b> represents a set of tools that enable better understanding and design of complex natural and energy systems. Large increases in computational capability, driven both by advances in chip technology and integration of more processors into massively parallel supercomputers, can impact all stages of the RDD&amp;D process. Research in areas such as materials for extreme environments, biofuel production, and photovoltaics can be accelerated thanks to larger and more complex simulations. In all of these areas, increases in computing power, the development of new mathematical algorithms, and increased integration of simulation with experimental validation will increase the importance of advanced simulation in energy technology.</p>	Processor technology	<b>Grid, Power, Buildings, Manufacturing, Fuels, Transportation</b>
	Parallelization	
	Algorithms	
	Integration of simulation with experimental validation	
<p><b>Data and analysis.</b> Opportunities to apply advanced analytics and management of extremely large data sets transect the entire clean energy economy. In particular, the ability to obtain actionable information from an ever-increasing quantity of data (“big data”) is both an opportunity and a research need. Increasingly inexpensive and effective ways to monitor and control data-dense energy systems is enabling novel and potentially more resource-efficient transaction-based control. Enhanced abilities to establish complex correlations in massive and disparate data sets and by automatically synthesizing the results of large numbers of research studies, can materially advance the scientific process.</p>	“Big data” tools	<b>Grid, Power, Buildings, Manufacturing, Fuels, Transportation</b>
	Semantic processing	
	Data dense monitoring and control	

**Table 2.1** Crosscutting Technology Table (continued)

Crosscutting theme description	Crosscutting technology	Sectors affected
<p><b>Analysis of complex systems.</b> Given the convergence of the energy system and its technical systems, advancements in the discipline of analysis of complex systems need to be coupled with the benefits of the confluence of theory, modeling, synthesis, and characterization and advancements in computational modeling and simulation, data and analysis, and decision science (including risk analysis) to effectively facilitate the transition to a clean energy economy.</p>	Complex networks	<p><b>Grid, Power, Buildings, Manufacturing, Fuels, Transportation</b></p>
	Complex systems	
	Model validation	
	Risk and uncertainty quantification	
<p><b>Characterization and control of matter at multi-scales.</b> Extraordinary advances in characterization and modeling of materials and chemistry have paved the way for design and control of materials at the atomic, nano-, and mesoscale to create new tailored functionalities.</p>	X-ray light sources	<p><b>Grid, Power, Buildings, Manufacturing, Fuels, Transportation</b></p>
	Neutron sources	
	Nanoscale materials theory, synthesis, fabrication, and characterization	

## Endnotes

- Carreras, B. A.; Newman, D. E.; Dobson, I. "Does Size Matter?" *Chaos: An Interdisciplinary Journal of Nonlinear Science* (24:2), 2014; 023104. Available at: <http://dx.doi.org/10.1063/1.4868393>.
- Buldyrev, S. V.; Parshani, R.; Paul, G.; Stanley, H. E.; Havlin, S. "Catastrophic Cascade of Failures in Interdependent Networks." *Nature* (464:7291), 2010; pp. 1025-1028. Available at: <http://dx.doi.org/10.1038/nature08932>.
- "Final Report on the August 14, 2003, Blackout in the United States and Canada." Federal Energy Regulatory Committee, U.S.-Canada Power System Outage Task Force, April 2004. Accessed April 21, 2015: <http://www.ferc.gov/industries/electric/indus-act/reliability/blackout/ch1-3.pdf>.
- "Cybersecurity for Smart Manufacturing Systems." National Institute of Standards and Technology, March 2014. Accessed March 30, 2015: <http://www.nist.gov/el/isd/csms.cfm>.
- Bartos, M. D.; Chester, M. V. "The Conservation Nexus: Valuing Interdependent Water and Energy Savings in Arizona." *Environmental Science and Technology* (48), 2014; pp. 2139-2149. Available at: <http://dx.doi.org/10.1021/es4033343>.
- McCalley, J.; Krishnan, V.; Gkritza, K.; Brown, R.; Mejia-Giraldo, D. "Planning for the Long Haul." *IEEE Power & Energy Magazine* (11:5), 2013; pp. 24-35. Available at: <http://dx.doi.org/10.1109/mpe.2013.2268712>.
- Buldyrev, S. V.; Parshani, R.; Paul, G.; Stanley, H. E.; Havlin, S. "Catastrophic Cascade of Failures in Interdependent Networks." *Nature* (464:7291), 2010; pp. 1025-1028. Available at: <http://dx.doi.org/10.1038/nature08932>.
- Newman, D. E.; Nkei, B.; Carreras, B. A.; Dobson, I.; Lynch, V. E.; Gradney, P. "Risk Assessment in Complex Interacting Infrastructure Systems." *System Sciences, 2005. HICSS '05. Proceedings of the 38th Annual Hawaii International Conference, January 3-6, 2005*; p. 63c. Available at: <http://dx.doi.org/10.1109/HICSS.2005.524>.
- U.S. Department of Energy, "The Water-Energy Nexus: Challenges and Opportunities", June 2014. <http://www.energy.gov/downloads/water-energy-nexus-challenges-and-opportunities>.
- Morrow, W. R., III; Gopal, A.; Fitts, G.; Lewis, S.; Dale, L.; Masanet, E. "Feedstock Loss from Drought Is a Major Economic Risk for Biofuel Producers." *Biomass & Bioenergy* (69), 2014; pp. 135-143. Available at: <http://dx.doi.org/10.1016/j.biombioe.2014.05.006>.
- "Air to Water Heat Pump Systems." Daikin Industries Ltd., 2015. Accessed March 28, 2015: [http://www.daikin.com/products/ac/lineup/heat\\_pump/index.html](http://www.daikin.com/products/ac/lineup/heat_pump/index.html).
- "Defender Safety System and Non-defender TTW2 Power Vent Water Heaters." Bradford White Water Heaters, 2015. Accessed March 28, 2015: <http://www.bradfordwhite.com/defender-safety-system-and-non-defender-ttw2-power-vent-models>.
- "SolarWall PV/Thermal Hybrid Solar Heating." Conservall Engineering Inc. 2014. Accessed March 28, 2015: <http://solarwall.com/en/products/pvthermal.php>.
- Cates, M. R. "Hybrid Lighting: Illuminating Our Future." *Oak Ridge National Laboratory Review* (29:3), March 1996. Oak Ridge, TN. Accessed April 27, 2015: [http://web.ornl.gov/info/ornlreview/rev29\\_3/text/contents.htm](http://web.ornl.gov/info/ornlreview/rev29_3/text/contents.htm).
- "All In One 24-inch Compact Washer/Dryer." LG Electronics, 2015. Accessed March 28, 2015: <http://www.lg.com/us/washer-dryer-combos/lg-WM3455HW-washer-dryer-combo>.

- <sup>16</sup> “Multifunction Printers.” Xerox Corporation, 2015. Accessed March 28, 2015: <http://www.shop.xerox.com/shop/office-equipment/multifunctions>.
- <sup>17</sup> Liu, G.; Larson, E. D.; Williams, R. H.; Kreutz, T. G.; Guo, X. “Making Fischer-Tropsch Fuels and Electricity from Coal and Biomass: Performance and Cost Analysis.” *Energy & Fuels* (25), 2011; pp. 415-437. Available at: <http://dx.doi.org/10.1021/ef101184e>.
- <sup>18</sup> “Climate Change 2014: Synthesis Report, Summary for Policymakers.” Fifth Assessment Report of the Intergovernmental Panel on Climate Change. IPCC, November 2014. Available at: [http://www.ipcc.ch/pdf/assessment-report/ar5/wg1/WG1AR5\\_SPM\\_FINAL.pdf](http://www.ipcc.ch/pdf/assessment-report/ar5/wg1/WG1AR5_SPM_FINAL.pdf).
- <sup>19</sup> Helbing, D. “Globally Networked Risks and How to Respond.” *Nature* (497:7447), 2013; pp. 51-59. Available at: <http://dx.doi.org/10.1038/nature12047>.
- <sup>20</sup> Ibid.
- <sup>21</sup> Carreras, B. A.; Lynch, V. E.; Dobson, I.; Newman, D. E. “Complex Dynamics of Blackouts in Power Transmission Systems.” *Chaos* (14:3), September 2004; pp. 643-652. Available at: <http://dx.doi.org/10.1063/1.1781391>.
- <sup>22</sup> Carreras, B. A.; Newman, D. E.; Dobson, I.; Poole, A. B. “Evidence for Self Organized Criticality in a Time Series of Electric Power System Blackouts.” *IEEE Transactions on Circuits and Systems I* (51:9), September 2004; pp. 1733-1740. Available at: <http://dx.doi.org/10.1109/TCSI.2004.834513>.
- <sup>23</sup> Bar-Yam, Y. “General Features of Complex Systems.” Chapter 1. Kiel, L. D., ed. *Knowledge Management, Organizational Intelligence and Learning, and Complexity. In Encyclopedia of Life Support Systems (EOLSS)*. Paris, France: Developed under the Auspices of the UNESCO, Eolss Publishers, 2002. Available at: <http://www.eolss.net>.
- <sup>24</sup> Braha, D.; Minai, A.; Bar-Yam, Y. “Complex Engineered Systems: A New Paradigm.” Chapter 1. Braha, D.; Minai, A.; Bar-Yam, Y., eds. *Complex Engineered Systems*. New York, NY: Springer, 2006; pp. 1-21.
- <sup>25</sup> Helbing, D. “Globally Networked Risks and How to Respond.” *Nature* (497:7447), 2013; pp. 51-59. Available at: <http://dx.doi.org/10.1038/nature12047>.
- <sup>26</sup> Buldyrev, S. V.; Parshani, R.; Paul, G.; Stanley, H. E.; Havlin, S. “Catastrophic Cascade of Failures in Interdependent Networks.” *Nature* (464:7291), 2010; pp. 1025-1028. Available at: <http://dx.doi.org/10.1038/nature08932>.
- <sup>27</sup> Newman, D. E.; Nkei, B.; Carreras, B. A.; Dobson, I.; Lynch, V. E.; Gradney, P. “Risk Assessment in Complex Interacting Infrastructure Systems.” *System Sciences, 2005. HICSS '05. Proceedings of the 38th Annual Hawaii International Conference, January 3-6, 2005*; p. 63c. Available at: <http://dx.doi.org/10.1109/HICSS.2005.524>.
- <sup>28</sup> Ibid.
- <sup>29</sup> Reis, S. D. S.; Hu, Y.; Babino, A.; Andrade, J. S.; Canals, S.; Sigman, M.; Makse, H. A. “Avoiding Catastrophic Failure in Correlated Networks of Networks.” *Nature Physics* (10), September 2014, pp. 762-767. Available at: <http://dx.doi.org/10.1038/nphys3081>.
- <sup>30</sup> “Multifaceted Mathematics for Complex Energy Systems (M2ACS).” Annual Report FY 2014. September 2014 (internal only).
- <sup>31</sup> Helbing, D. “Traffic and Related Self-driven Many-particle Systems.” *Reviews of Modern Physics* (73:4), 2001; pp. 1067-1141. Available at: <http://dx.doi.org/10.1103/RevModPhys.73.1067>.
- <sup>32</sup> Kumar, S.; Shi, L.; Ahmed, N.; Gil, S.; Katabi, D.; Rus, D. “CarSpeak: A Content-Centric Network for Autonomous Driving.” *ACM Sigcomm Computer Communication Review* (42:4), 2012; pp. 259-270. Available at: <http://dx.doi.org/10.1145/2377677.2377724>.
- <sup>33</sup> Reichardt, D.; Miglietta, M.; Moretti, L.; Morsink, P.; Schulz, W.; Inria, I. “CarTALK 2000 Safe and Comfortable Driving Based upon Inter-vehicle-communication.” *IV 2002: IEEE Intelligent Vehicle Symposium, Proceedings, 2002*; pp. 545-550. Available at: <http://dx.doi.org/10.1109/IVS.2002.1188007>.
- <sup>34</sup> Li, F.; Wang, Y. “Routing in Vehicular Ad Hoc Networks: A Survey.” *IEEE Vehicular Technology Magazine* (2:2), 2007; pp. 12-22. Available at: <http://dx.doi.org/10.1109/mvt.2007.912927>.
- <sup>35</sup> Levinson, J.; Askeland, J.; Becker, J.; Dolson, J.; Held, D.; Kammel, S.; Kolter, J. Z.; Langer, D.; Pink, O.; Pratt, V.; Sokolsky, M.; Stanek, G.; Stavens, D.; Teichman, A.; Werling, M.; Thrun, S. “Towards Fully Autonomous Driving: Systems and Algorithms.” 2011 IEEE Intelligent Vehicles Symposium (IV), 2011; pp. 163-168. Available at: <http://dx.doi.org/10.1109/IVS.2011.5940562>.
- <sup>36</sup> Lugaric, L.; Krajcar, S.; Simic, Z. “Smart City—Platform for Emergent Phenomena Power System Testbed Simulator.” *Innovative Smart Grid Technologies Conference Europe (ISGT Europe)*, October 11–13, 2010, Gothenburg, Sweden. *IEEE PES* (1:7), 2010; pp. 11-13. Available at: <http://dx.doi.org/10.1109/ISGTEUROPE.2010.5638890>.
- <sup>37</sup> Amin, M. “National Infrastructures as Complex Interactive Networks.” Chapter 14. Samad, T.; Weyrauch, J., eds. *Automation, Control and Complexity: An Integrated Approach*. ISBN: 0-471-81654-X. West Sussex, England: John Wiley and Sons, 2000; pp 263-286.
- <sup>38</sup> “Urban Informatics.” Center for Urban Science and Progress (CUSP) at New York University (NYU), 2015. Accessed February 15, 2015: <http://cusp.nyu.edu/urban-informatics/>.



## Issues and RDD&D Opportunities

- Fundamental changes in electricity generation and use are requiring the electricity system to perform in ways for which it was not designed—requiring new capabilities and system designs to maintain historical levels of reliability.
- American industry and commerce demand affordable, high-quality power with high reliability to support an increasingly digital economy. As the nation's critical services become more digital and automated, power disruptions have potentially greater consequences.
- Advanced technologies to plan, manage, monitor, and control electricity delivery are needed to enable safe and reliable two-way flow of electricity and information, support growing numbers of distributed energy resources, and support customers participating in electricity markets as both power suppliers and demand managers.
- Research, development, demonstration, and deployment opportunities exist to accomplish the following:
  - Develop and refine interoperable grid architectures and new system designs
  - Develop software and visualization tools that use new data from transmission and distribution system devices for enhanced, real-time operations and control
  - Research material innovations and develop transmission and distribution component designs for higher performance, reliability, and resilience
  - Embed intelligence, communication, and control capabilities into distributed energy resources and systems such as microgrids to support grid operations
  - Improve energy storage capabilities and systems designs that lower costs while increasing capacity and performance, and facilitating integration
  - Develop high-fidelity planning models, tools, and simulators and a common framework for modeling, including databases
  - Design innovative technologies and resilient and adaptive control systems to improve physical- and cyber-security of the grid



# 3

## Enabling Modernization of the Electric Power System

### 3.1 Introduction

The electric power system is facing increasing stress due to fundamental changes in both supply and demand technologies. On the supply side, there is a shift from large synchronous generators to lighter-weight generators (e.g., gas-fired turbines) and variable resources (renewables). On the demand side, there is a growing number of distributed and variable generation resources, as well as a shift from large induction motors to rapidly increasing use of electronic converters in buildings, industrial equipment, and consumer devices. The communications and control systems are also transitioning from analog systems to systems with increasing digital control and communications; from systems with a handful of control points at central stations to ones with potentially millions of control points.

All the while, the system is being asked to perform in ways and in a context for which it was not designed. The result is a system that is under increasing stress from these and other factors and requires much greater flexibility, agility, and ability to dynamically optimize grid operations in time frames that are too fast for human operators. Fundamental advances in the power system are needed to address these changes and ensure system reliability. The Southwest Blackout in 2011, for example, was the result of a cascading failure that took place in seconds—too fast for human intervention. These fundamental changes, however, also open a set of opportunities that can be tapped to significantly improve performance, lower costs, and address our national energy challenges. The research needs that can help realize these opportunities are described in this chapter.

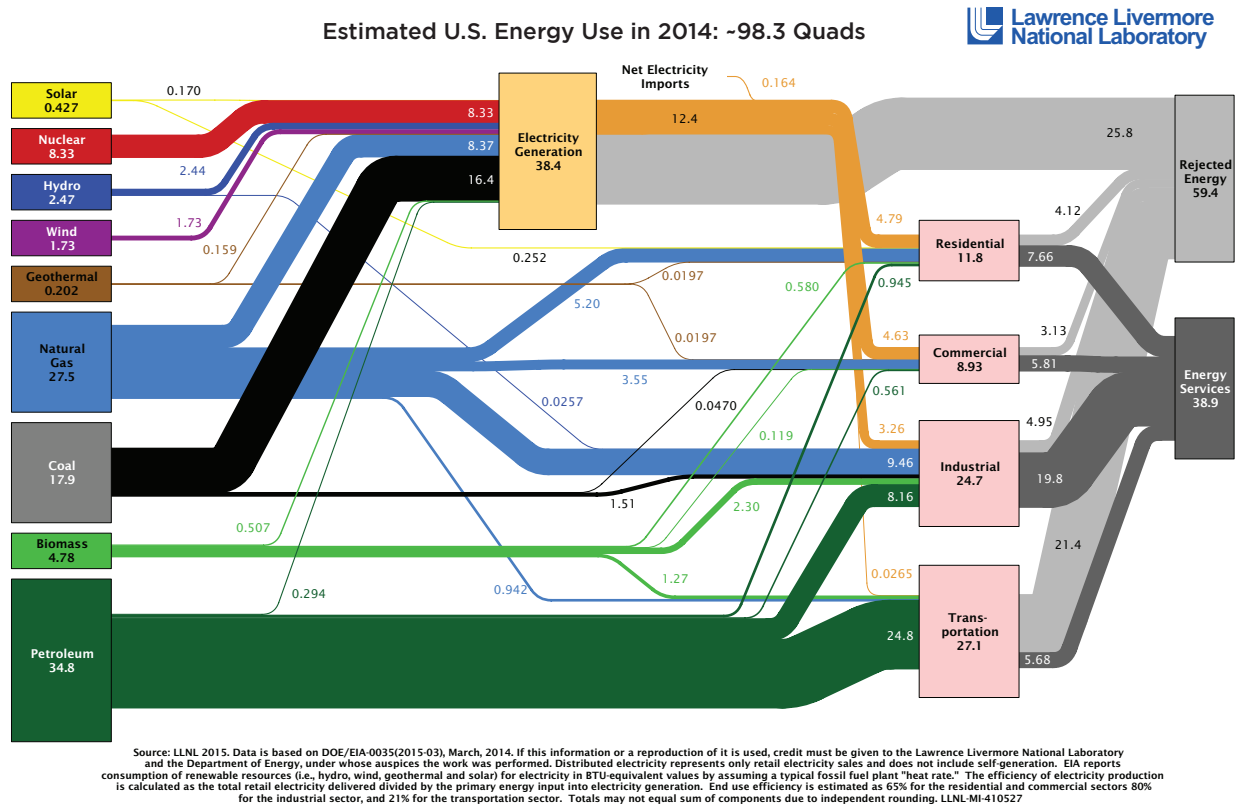
The U.S. electric power system is the centerpiece of the nation's energy economy. Of the roughly 97 quads (quadrillion British thermal unit) of energy used in the United States in 2014, about 38 quads were transformed into 3,900 terawatt-hours of electricity for delivery by an extensive infrastructure of more than 19,000 generators, 55,000 transmission substations, 642,000 miles of high-voltage lines, and 6.3 million miles of distribution lines to serve 145 million customers.<sup>1</sup> Electricity generation accounts for the largest proportion of U.S. energy use: nearly all of the nation's coal, nuclear, and non-biomass renewable sources consumed and one-third of natural gas sources (see Figure 3.1). The system is owned and operated by more than 3,000 utilities and is overseen by thousands of municipal, state, and federal officials.

Virtually every aspect of American commerce and industry depends on the continuous availability of affordable electric power. Electricity use is projected to grow by 25% from 2013 to 2040.<sup>2</sup> Although the rate of growth in electricity use will continue to slow—as it has since the 1950s, largely due to energy-efficiency improvements and a transition toward a service-based economy (moving away from heavy manufacturing)—the nation's reliance on a reliable, efficient, and resilient power grid is rising. This dependency grows as businesses, homes, and communities increasingly integrate digital technologies and automated systems into nearly all aspects of modern life. This dependence is highlighted when widespread power interruptions affect whole communities and regions due to catastrophic natural disasters.

An increasing reliance on electricity presents significant challenges for utilities, state-level decision makers, and other stakeholders, who must improve reliability and resilience while cost-effectively managing the fundamental changes required to meet the needs of a low-carbon, digital economy. The electric power system is currently undergoing significant changes in the sources we rely on to generate electricity, the means by which we receive electricity, and even in the ways we consume electricity.

**Figure 3.1** Estimated U.S. Energy Use in 2014: ~98.3 Quads

Credit: Lawrence Livermore National Laboratory



Electricity generation accounts for a significant portion of annual U.S. energy use, including nearly all coal, nuclear, and non-biomass renewable sources, and nearly a third of natural gas.

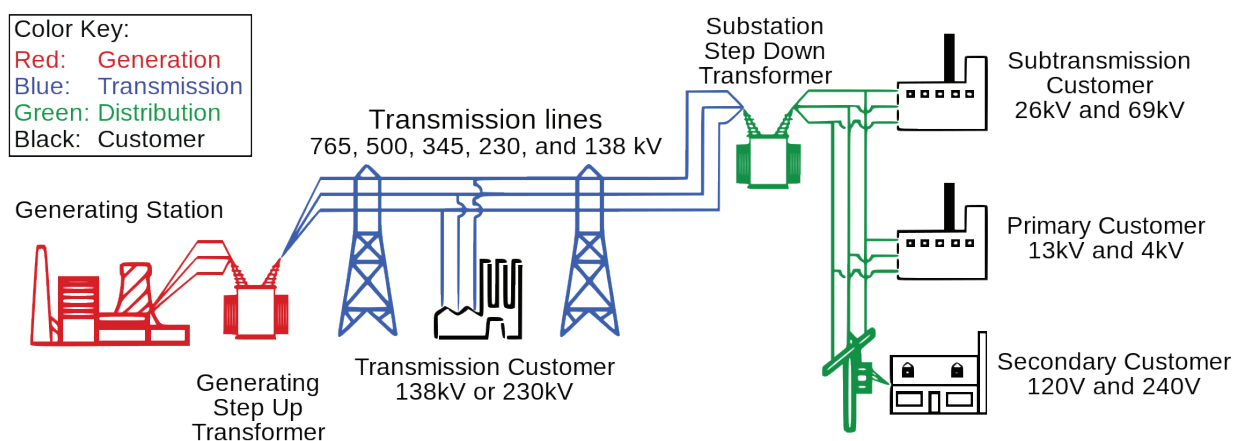
This chapter of the Quadrennial Technology Review (QTR) focuses on the research, development, demonstration, and deployment (RDD&D) needs to develop a modern electric power system. Yet, it is important to note that the reliable delivery of electricity also depends on the structure and dynamics of electricity markets as well as federal, state, and local policies and regulations. These issues are addressed in the 2015 Quadrennial Energy Review.

### 3.1.1 Modernization of the Electric Power System

The U.S. electric power system has provided highly reliable electricity for more than a century, yet much of the current electric grid was designed and built decades ago using system design models and organizational principles that must be restructured to meet the needs of a low-carbon, digital economy. The traditional architecture was based on large-scale generation remotely located from consumers, hierarchical control structures with minimal feedback, limited energy storage, and passive loads. This traditional architecture is graphically illustrated in Figure 3.2.

This traditional system was not designed to meet many emerging trends, such as greater adoption of relatively low inertia generation sources, growing penetration of distributed generation resources, and the need for greater resilience. As described in several recent studies, a modern grid must be more flexible, robust, and agile.<sup>3</sup> It must have the ability to dynamically optimize grid operations and resources, rapidly detect and mitigate disturbances, integrate diverse generation sources (on both the supply and demand sides), integrate demand response and energy-efficiency resources, enable consumers to manage their electricity use and participate in markets, and provide strong protection against physical and cyber risks.<sup>4</sup> These features must be incorporated as the electric grid transitions from the traditional design to the design of the future.

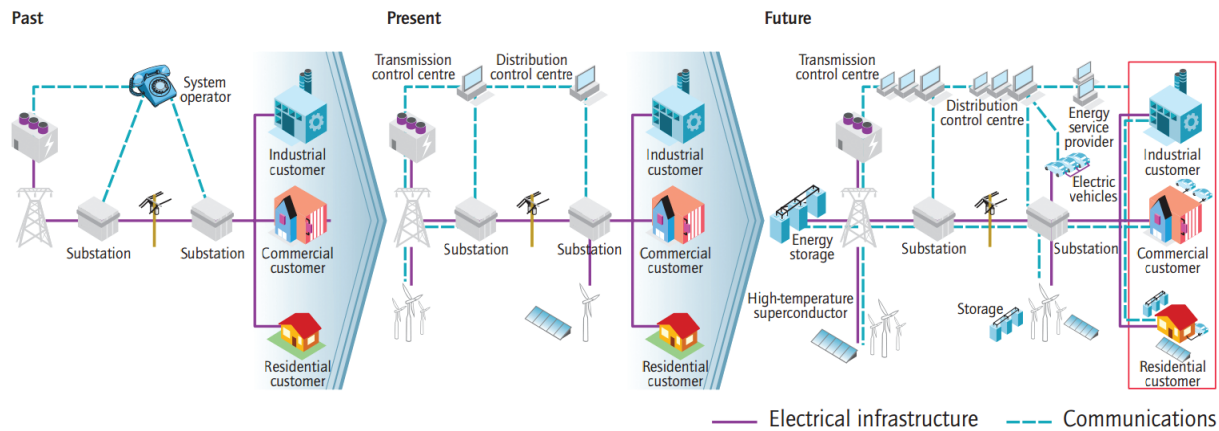
**Figure 3.2** Traditional Electricity Delivery System



The traditional architecture was based on large-scale generation; centralized, one-way control; and passive loads.

Figure 3.3 shows an example of how the system can transform from the traditional centralized model to an integrated hybrid centralized/decentralized system with increasing communications and computing capabilities. This transition to a modern grid requires the adoption of advanced technologies, such as smart meters, automated feeder switches, fiber optic and wireless networks, storage, and other new hardware. These devices require a new communication and control layer to manage a changing mix of supply- and demand-side resources and provide new services.<sup>5</sup> New technologies for electricity delivery—along with other infrastructure improvements, capacity additions, and changes in market structures and public policies—are needed to enable safe and reliable two-way flow of both electricity and information, support growing numbers of distributed energy resources, and support growing numbers of customers participating in electricity markets as both power suppliers and demand managers.

Grid modernization must encompass the application of intelligent technologies, next-generation components with “built-in” cybersecurity protections, advanced grid modeling and applications, distributed generation, and innovative control system architectures. The Electric Power Research Institute and others estimate this will require \$338–\$476 billion of new investment (in addition to investments for reliability and replacement) over the next twenty years.<sup>6</sup> This transformation must be efficient and cost-effective to achieve a more reliable, resilient, and clean electric power sector for the United States.

**Figure 3.3** Evolution of the Electric Power GridCredit: © OECD/IEA 2011 Technology Roadmap: Smart Grids, IEA Publishing. License: <http://www.iea.org/t&c/termsandconditions/>

The electric power grid is evolving to include more distributed control; two-way flows of electricity and information; more energy storage; and new market participants, including consumers as energy producers.

### 3.1.2 Drivers for Changes in the Electric Power System

Far-reaching changes in technologies, markets, and public policies are transforming electricity delivery. There are five key trends driving this transformation:

- Changing mix and characteristics of electricity generation sources that are shifting electricity generation from relatively few large central station plants to many smaller and sometimes variable generators
- Changing demand loads in retail electricity markets resulting from demographic and economic shifts; the adoption of more energy-efficient, end-use technologies; growing consumer participation; broader electrification; and use of electronic converters (rather than induction motors and other types of loads with favorable inertia and droop curves)<sup>7</sup>
- Integration of smart grid technologies for managing complex power systems, driven by the availability of advanced technologies that can better manage progressively challenging loads
- Growing expectations for a resilient and responsive power grid in the face of more frequent and intense weather events, cyber and physical attacks, and interdependencies with natural gas and water systems
- Aging electricity infrastructure that requires new technologies to enable better failure detection, upgrade capabilities, and improve cybersecurity

#### Changing Mix and Characteristics of Electricity Generation Sources

The nation's electric generation mix is in the midst of substantial change. From 2000 to 2013, natural gas' share of the power generation mix grew from about 16% to more than 27%, and the renewables share increased from more than 9% to about 13%, while coal's share decreased from almost 53% to about 40%.<sup>8</sup> These trends are projected to continue.

Because electricity is not easily stored, balancing authorities must continuously match electricity supply with demand on a second-by-second basis to maintain reliability. The growing penetration of variable generation resources, such as wind and solar, adds higher levels of non-dispatchable resources to the system.<sup>9</sup> With more variable generation, transmission system operators require tools and resources to maintain reliability while addressing the need for short, steep ramps; the potential for over-generation—particularly with distributed generation where curtailment is not readily achievable; and decreased frequency response. These changes require new ways for managing grid operations to increase the flexibility of the system such as expanding balancing areas, increasing the ramping capability of the generation fleet, using dispatchable demand resources, adding power flow controllers, and increasing energy storage to maintain reliability.

### Changing Demand Loads in Retail Electricity Markets

Changes in customer preferences are also affecting utility markets and electricity delivery.<sup>10</sup> For example, growing installations of more affordable rooftop photovoltaic (PV) arrays and more energy-efficient appliances, buildings, and industrial equipment, are reducing the amount of electricity needed from power companies. This is changing the traditional business models of the regulated utility industry.<sup>11</sup>

Consumers are increasingly becoming “prosumers” who both use and produce electricity. For example, the number of homes in the United States with solar PV installations has grown from 15,500 in 2004 to more than 600,000 by the end of 2014. The total generation capacity of residential PV today is about 1,460 megawatts (MW), and more than 80% of that capacity was added in the past four years.<sup>12</sup>

The use of digital electronics and computer controls in homes, offices, and factories is also on the rise, enabling the nation’s electricity consumers to operate more efficiently and expand capabilities for improving productivity and performance. Changes from purely electro-mechanical to power-electronic-based components affect power quality requirements and other aspects of grid operations. For example, in many industrial and consumer applications, induction motor loads have been replaced by variable speed drive systems. Fans, pumps, and motors—in applications ranging from sewage treatment to air conditioning—have been equipped with electronic drive systems that offer increased control, and tremendous efficiency gains. However, the electronic drive systems decouple the inertia of these motor loads from the system, preventing them from supporting the stability of the grid during disturbances.

In addition, these drive systems regulate the power delivered to the motor. When the power system voltage is declining, indicating an abnormal condition on the system, the power consumption of most system loads will decline proportionally. However, electronically coupled loads can continue to draw full power, exacerbating the abnormal condition, leading to voltage collapse.

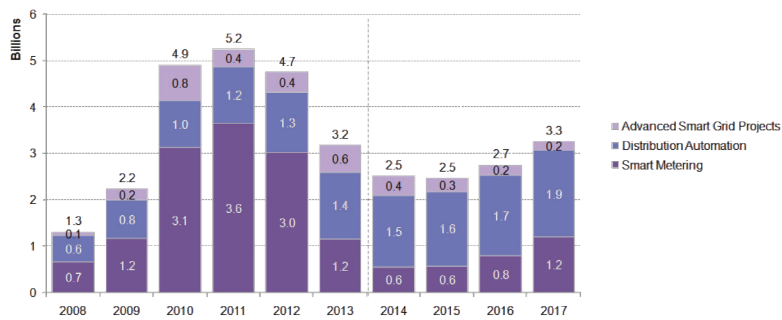
On the horizon are prospects for growing fleets of plug-in electric vehicles that could increase electricity demand in the transportation sector, which today is fueled mostly with petroleum (92%).<sup>13</sup> If sales projections—of a compound annual growth rate of 18.6% between 2013 and 2022—are realized and continue, electric vehicle charging will be a significant new source of electricity demand. With the installation of smart meters, and the application of time-based rates, electric grid management techniques could be used to encourage off-peak charging to mitigate peak demands and avoid the need for costly capacity additions.

## Integration of Smart Grid Technologies for Managing Complex Power Systems

New digital devices and communications and control systems (often referred to as “smart grid” devices) are improving the ability of operators to monitor and manage electric transmission and distribution systems

**Figure 3.4** Spending on Smart Grid Technologies 2008-2013, with Projections to 2017

Credit: Bloomberg New Energy Finance



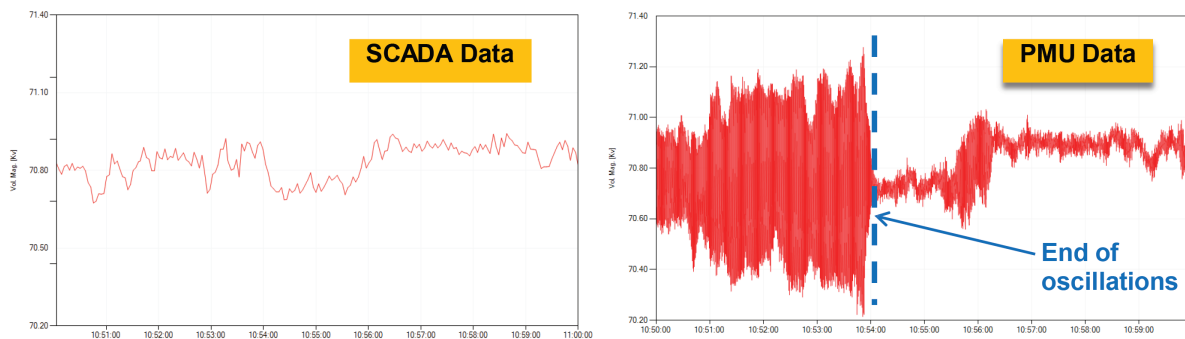
Smart grid spending spiked from 2010 to 2012, in part due to American Recovery and Reinvestment Act of 2009 (ARRA) smart grid funding, and is projected to continue steadily through 2017.

and customers. This has created challenges in managing and analyzing large volumes of data and the need to develop new tools for data management, visualization, and analytics.<sup>15</sup>

While technology advancements for monitoring the system are occurring, such as the deployment of PMU technology, further advancement is needed in the control systems, algorithms, and grid models that utilize these data.<sup>16</sup> For example, PMU technology can detect low-frequency oscillations that were missed by supervisory control and data acquisition (SCADA) systems, allowing operators to take action and prevent widespread disturbances (see Figure 3.5). However, the use of data for automated, coordinated, system-level control remains an area of research rather than practice. At the distribution level, automated controls for voltage and reactive power management technologies are now being deployed by some utilities to address power quality requirements and enhance conservation.

**Figure 3.5** Comparison between Voltage Signals from the Event as Captured by SCADA versus PMU Data for Western Electricity Coordinating Council Wind Farm Oscillations

Credit: Iknor Singh, “Synchrophasor Technology Use Cases - Wind Farm Oscillation Detection and Mitigation,” Electric Power Group, LLC (2014): Figure 3, screenshot from Phasor Grid Dynamics Analyzer.



PMU data provides data at significantly shorter timescales, improving operators’ understanding of grid operations and speed in detecting potential disturbances.

## Growing Expectations for a Resilient and Responsive Power Grid

Electricity disruptions are estimated to cost the economy roughly \$80 billion or more annually and seriously endanger public health and safety.<sup>17</sup> The growing interdependence of the electricity infrastructure with other critical infrastructures (such as communications and information technology, water, fuels, and transportation) is increasing the consequences of power outages.

Natural disasters such as Hurricane Katrina and Superstorm Sandy demonstrate the overwhelming economic and human loss that results when storms devastate large areas and damage the electric power system.<sup>18</sup> Increasing weather-related outages (as demonstrated in Figure 3.6) can affect millions of people and cause economic losses of \$10 billion or more from power disruptions.<sup>19</sup> Yet, severe storms are not the only threat; sophisticated cyber attacks have emerged as a high-risk source of potential harm, requiring strong cybersecurity technologies and practices from design through implementation.<sup>20</sup>

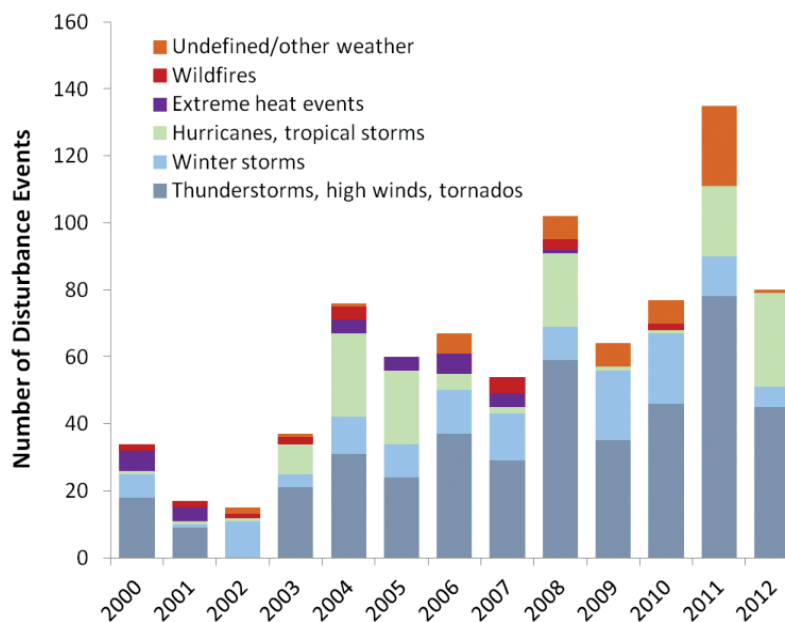
A variety of techniques are being evaluated to address these new requirements and boost the resilience of the electric power system. For example, the development and deployment of new technologies and systems is helping utilities to reduce the frequency and duration of outages, and boost outage management capabilities that shorten restoration times when outages do occur. Microgrids, used at some hospital complexes, industrial parks, municipal areas, and universities, can be operated as an “island” when local and regional power is disrupted, and then resynchronized when power is restored. Equipment health sensors on substation transformers and other equipment can be used for preventive maintenance to reduce device failures and mitigate power outages.

### Aging Electricity Infrastructure

The traditional electricity architecture was designed for “passive” loads and communications with distributed components was not necessary. As aging infrastructure is replaced, and smart meters and other digital communication and control devices proliferate, operators will require advanced control systems and distribution management systems that can securely manage new digital technology and use the new data to inform system operations.

Currently, 70% of large power transformers and transmission lines are twenty-five years or older, and 60% of circuit breakers are thirty years or older.<sup>21</sup> A catastrophic failure of a transmission asset threatens system reliability, and changing system dynamics may increase the likelihood that this can happen. As assets are replaced, there is an opportunity to install next-generation, higher-performance components, but overall cost needs to be managed and optimized.

**Figure 3.6** Weather-Related Grid Disruptions, 2000-2012



Trends show steadily increasing weather-related grid disruptions, with major disruptions every few years.

### 3.1.3 RDD&D for Modernizing the Electric Power System

The development of new technologies and investments in new infrastructure to modernize the electric power system is largely a private-sector responsibility. Utilities, power providers, consumers, and technology developers make investment decisions in complex and changing regulatory and market conditions. This may cause decision makers to seek locally optimized solutions based on regulatory and economic constraints. Through collaborative RDD&D, DOE can help to catalyze, accelerate, and facilitate the adoption of advanced technologies, tools, and techniques that will benefit the overall system.

DOE invests in grid-related energy RDD&D projects that have large societal and system-wide benefits and are too risky for the private sector to develop on its own. These projects are part of an overall strategy that complements and expands upon existing RDD&D being performed by the private sector and others. In addition, researchers at federal laboratories can help develop new ideas and concepts, promote information sharing and technology transfer, and facilitate collaborations among industry groups and academia to spur innovation and invention.

Investments in RDD&D are needed to help accelerate grid modernization for several reasons:

- **National security:** While the private sector has the primary responsibility for developing, building, and operating the nation's electric power system, electricity is critical to commerce and society; any sustained outage can jeopardize human health and safety, as well as national security. Critical infrastructure protection and resilience are a shared public-private responsibility. DOE investments in cyber- and physical-security RDD&D can help develop innovative solutions to mitigate systemic vulnerabilities, enhance overall national security, and reduce economic impact of major disruptions.
- **Infrastructure resilience:** Electricity outages are increasing due to climate change-influenced effects such as severe weather events and rising sea-water levels. However, the uncertainty regarding these risks and other factors has resulted in little private sector investment.
- **Clean energy goals:** While the transformation of the electric power system may be gradual, federal investments could help align and accelerate the transition to meet national goals. Advanced technology options are needed to address the increased complexity and faster system dynamics, especially as the dependence on variable and distributed generation grows. Seamless integration of advanced technologies will also require the convening power of the federal government to ensure interoperability across different regulatory structures and organizational boundaries.
- **Catalyzing private-sector innovation:** The development and now widespread U.S. adoption of synchrophasor technologies for wide-area situational awareness is an example of DOE RDD&D investments catalyzing private sector investment and innovation that would not have happened without DOE support. DOE electricity R&D investments focus on technologies with insufficient private sector investment, but which could produce large public benefits if successfully commercialized.

Building a robust and resilient system as the transformation takes place, rather than a piecemeal approach, helps ensure that we effectively address national challenges.

Large-scale changes in electricity generation, demand, and customer roles are creating technical challenges for the U.S. electric power system that will require new technologies and capabilities. Both the transmission and distribution system, and the underlying grid architecture, will require transformational changes to address emerging technical issues.



## 3.2 Technical Issues Underpinning Grid Modernization

The United States is facing shifting patterns of energy supply and demand, changing operational and market environments, and an evolving risk environment, as discussed in Section 3.1. The complex infrastructure and long-established technical approaches to managing the grid make adapting to the changing environment challenging. This section outlines the component structures of the grid and the related technical challenges.

### 3.2.1 Transmission System

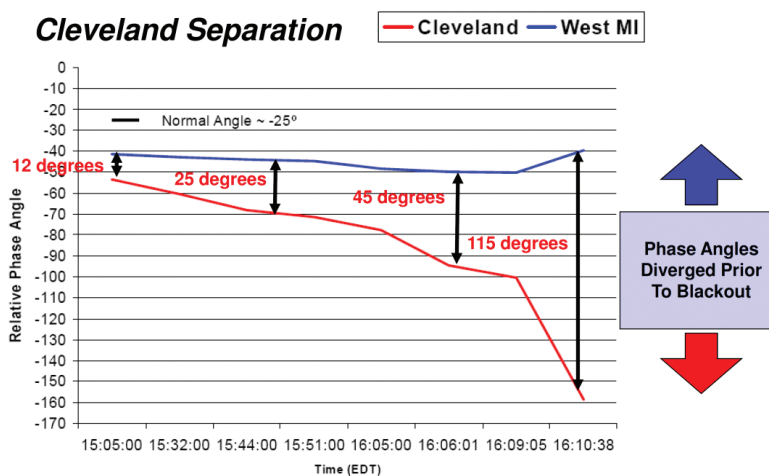
The bulk transmission system is the backbone of the electric grid and has historically provided the opportunity for economies of scale in generation plants to provide low-cost electricity. This network of high-voltage lines (more than 100 kilovolts) connects large-scale generators to distribution. The rapidly changing generation mix is producing power flows that are different than what the network was built to accommodate. This leads to system congestion that costs rate-payers billions of dollars every year. Over the last decade, annual congestion costs ranged between \$529 million and more than \$2 billion in PJM, the largest system operator in the United States.<sup>22</sup>

The August 14, 2003 Northeast Blackout highlights the extent to which the power system has become interconnected over time. The outage affected an estimated fifty million people and 61,800 MW of electric load. In some parts of the United States, electrical power was not restored for four days, affecting nearly all aspects of modern life.<sup>23</sup> The event demonstrated the need for reliability-related software tools to improve wide-area, real-time situational awareness, as well as more effective use of system protection measures.

Phase-angle separation is an indicator of grid stress, and can be detected using PMUs. Figure 3.7 shows the phase-angle separation that occurred shortly before the 2003 blackout, and what the operators could have observed had the technology been in place at that time. These measurements indicate the health of the power system.<sup>24</sup> They form the foundation for advanced applications, such as wide-area situational awareness and state estimation, system dynamics monitoring, system model validation, and in the near future, automated response-based controls.

**Figure 3.7** Example of Analysis using Synchrophasor Data: August 14, 2003 Blackout

Credit: North American Electric Reliability Corporation



Note: Angles are based on data from blackout investigation. Angle reference is Browns Ferry.

Operators may have detected the phase-angle separation that preceded the 2003 blackout had PMU technology been in place.

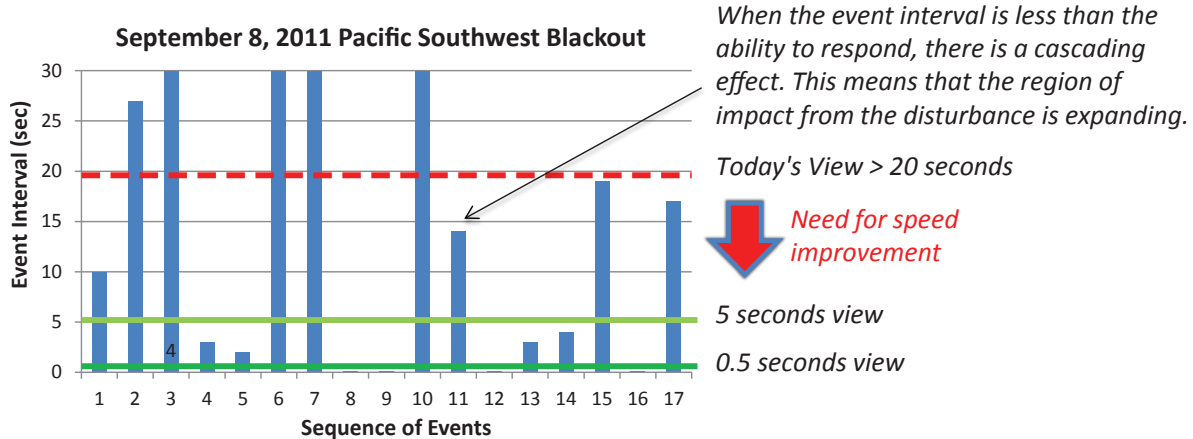
Under the American Recovery and Reinvestment Act (ARRA) of 2009, DOE supported the deployment of more than 1,300 PMUs across the nation—over a fivefold increase of the previously installed base. Without a sufficient density of PMUs, monitoring the emerging wide-area system dynamics would not be possible and thus, control of the entire grid could remain inadequate. One of the challenges for utilities today is that they may not have an adequate amount of sensor installations, and thus may not be able to observe their entire network.

The September 8, 2011 Southwest Blackout illustrates the need to link “real-time” situational awareness tools with “faster-than-real-time” or predictive analytical capabilities to evaluate potential risks and contingencies. It also highlights the limits to the speed at which humans can respond to a disturbance to manually execute mitigating actions. A system disturbance occurred in the Pacific Southwest, leading to cascading outages that left approximately 2.7 million customers without power, some for up to twelve hours.<sup>25</sup>

The 2011 Southwest Blackout disturbance is demonstrated by the sequence of events in Figure 3.8. When the event interval is less than the ability to respond, there is a cascading effect. This means that the region of impact from the disturbance could be expanding. It illustrates the intensity and changing state of the system, to which the operators must understand and respond. While data may arrive every two to four seconds, calculations depicting the state of the system and possible contingencies can take minutes or hours to assess. In the case of severe disturbances, the electric power system could transition to an unstable state within seconds, making it extremely challenging for operators to act without decision support capabilities or well-aligned planning analysis based on fast state estimation.

**Figure 3.8** Illustrative Sequence of Cascading Events in the 2011 Southwest Blackout

Credit: Pacific Northwest National Laboratory

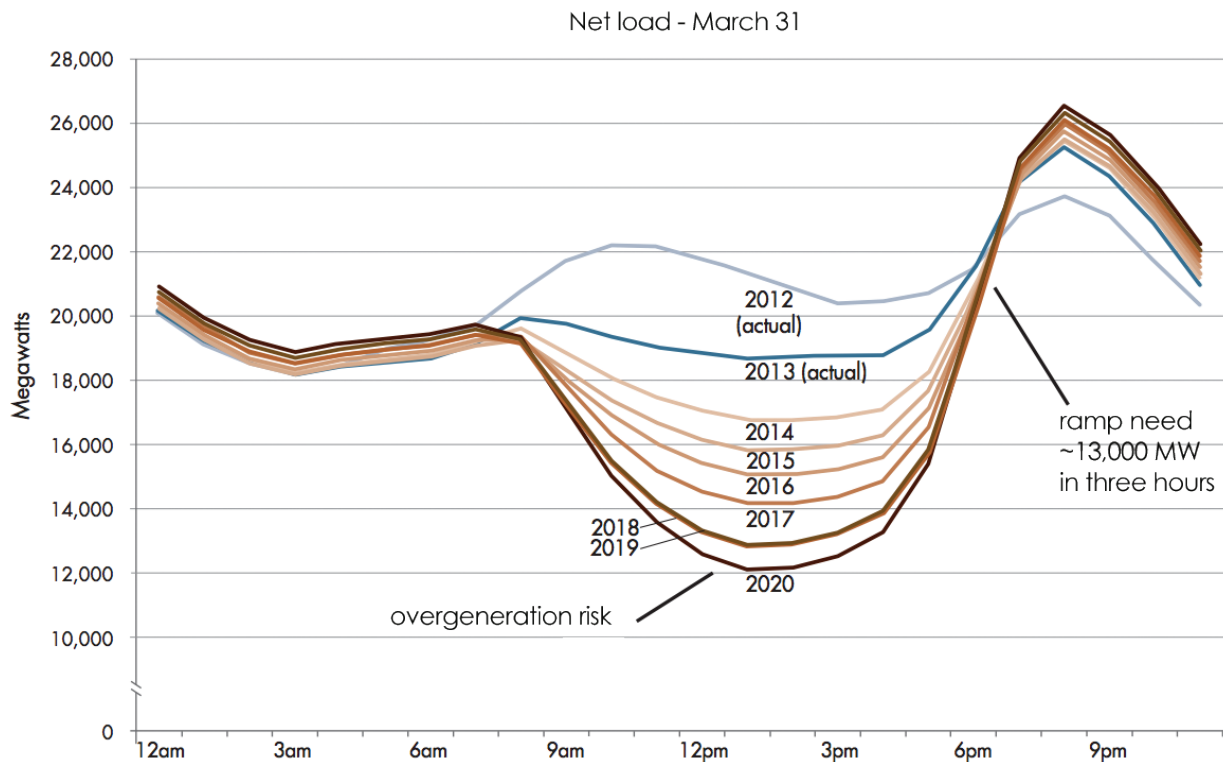


Many of the cascading events occurred in intervals of less than twenty seconds and some in intervals of less than five seconds, R&D is needed to perform state estimation in less than one second to allow operators the ability to detect and respond to cascading events.

The transition from traditional to modern electric transmission systems has been accelerated by public and private investments under the ARRA Smart Grid program. With the deployment of more than 1,300 networked PMUs, as noted above (contributing to a total of more than 1,800 now deployed throughout the North American network),<sup>26</sup> grid operators across the country now have greater visibility into system conditions. Tools are being developed to use synchrophasor data for grid planning and operations.<sup>27</sup> Over time, using these data to improve capabilities for managing power flows and addressing faults will help prevent minor disturbances from cascading into regional outages.

**Figure 3.9** California ISO Projected Electricity Supply

Credit: California Independent System Operator Corporation



In projected scenarios, variable renewable generation is plentiful midday, but decreases just as energy demand spikes in the early evening—requiring increased system flexibility to meet challenges with steep ramps and over-generation risks. Note the offset of the vertical scale.

New operating conditions are also emerging with the addition of renewable power, distributed generation, and energy storage at the transmission and distribution levels, as well as changing load characteristics. The “duck curve” (see Figure 3.9) illustrates the emerging conditions, including short, steep ramps; over-generation risk; and decreased frequency response.<sup>28</sup>

### 3.2.2 Distribution System

The distribution system, from distribution substations down to customers, was originally designed to be relatively passive. Typical distribution systems deliver electricity using distribution feeders and radial lines with control equipment operated through timed set points. While this design paradigm is sufficient to provide customers with basic, reliable electrical service at affordable costs, it cannot meet today’s needs for greater resilience, power quality, and consumer participation. Industry estimates show that approximately 90% of outage minutes originate on the distribution system. Because of the large number of connections (e.g., 145 million customers and 6.3 million miles of distribution lines), it is also often the most expensive part of the electricity delivery system and most difficult to upgrade.

New distributed energy technologies have been developed and demonstrated and are increasingly being connected to the grid. These include high-efficiency reciprocating engines, wind generators, plug-in electric vehicles, PV systems, micro-turbines, fuel cells, and energy storage systems. Ongoing improvements in

interconnection standards (e.g., IEEE Standard 1547) are defining the requirements that these technologies must meet for safe and reliable integration with utility electrical networks. These standards address issues such as power quality, voltage limits, and operating behavior to ensure that new technologies do not jeopardize the safety or reliability of the electric power system. Some interconnection cases require engineering studies, computer simulations, and the addition of new hardware and protective devices to ensure continued system operation and reliability.

To ensure line voltages remain within limits throughout the day, voltage regulation equipment with simple control set points and fixed schedules are used. This control paradigm is based on local sensors, electro-mechanical devices, and “static” intelligence achieved through engineering analysis of predictable loads. Advances in distribution automation technologies can improve system performance. Additionally, current system protection is achieved through fuses, breakers, and relays, while outages are located typically based on customer calls. This protection and outage management paradigm will also need to evolve using smart technologies.

As energy technologies advance and become more affordable, from distributed generation to home energy management systems, customers will have the ability to better manage their energy use and produce their own electricity. Enabling customers to become active participants in electric power system operations and energy exchanges will require a fundamental shift in how the distribution system is designed, controlled, and protected. Maintaining reliability, power quality, and safety in this new operating environment will require new and improved capabilities.

The transition from traditional to modern electric distribution systems using smart grid technologies is under way, but efforts are in the very earliest stages of development and deployment. DOE’s Smart Grid Investment Grants helped install thousands of automated feeder switches and capacitor banks, along with power line and equipment health sensors. These devices have shown the potential to enable fewer and shorter outages, and reduce energy requirements by using automated controls for voltage and reactive power management.<sup>29</sup> New tools and techniques are now needed to integrate and operate these devices through modernized distribution management systems.

### 3.2.3 Grid Architecture

The architecture of the grid will need to transform as the modernization process progresses. The characteristics of the future grid will be distinctly different from those of the current system (see Figure 3.10). This transformation is an enormous undertaking for utilities, regulators, consumers, manufacturers, and other electric power industry stakeholders.

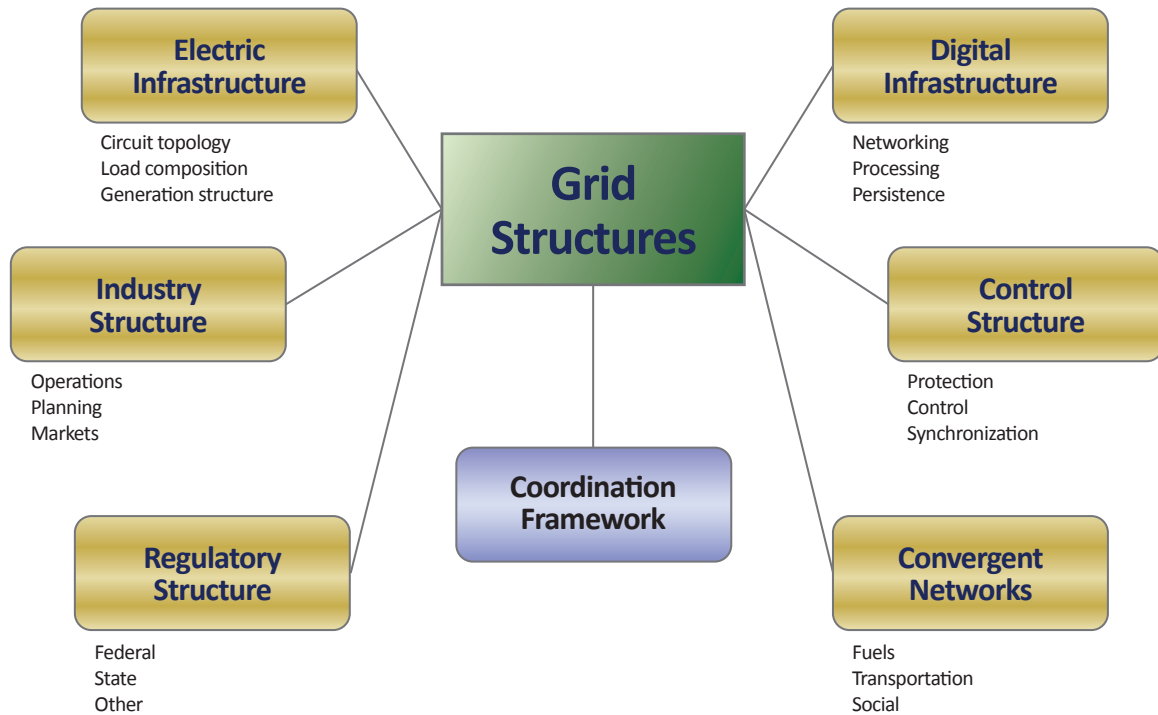
Grid architecture design provides the “structure” of the grid and thereby determines the essential bounds on what can and cannot be done within that framework. It is essential to recognize what these bounds

**Figure 3.10** Comparison of Key Attributes of Current and Future Systems

Current System	Future Paradigm
<ul style="list-style-type: none"> <li>• Monolithic</li> <li>• Centralized generation</li> <li>• Decisions driven by cost</li> <li>• Vulnerable to catastrophic events</li> <li>• Limited energy choices</li> <li>• Vulnerable to new threats</li> </ul>	<ul style="list-style-type: none"> <li>• Modular and agile</li> <li>• Centralized and distributed generation</li> <li>• Decisions driven by cost and environmental sustainability</li> <li>• Contained events</li> <li>• Personalized energy options</li> <li>• Inherently secure against threats</li> </ul>

are, to change them where necessary, and to understand the interactions and consequences of the various grid structures. The discipline of grid architecture provides a modern set of methods to assist in thinking about grid complexities, to aid in understanding interactions and technical gaps, to enable new capabilities and remove old unnecessary limits, and

**Figure 3.11** Grid Architecture Structure Types



The grid can be viewed as six interrelated structures and a coordination framework to understand the needs and requirements necessary to meet the performance expectations of a digital economy.

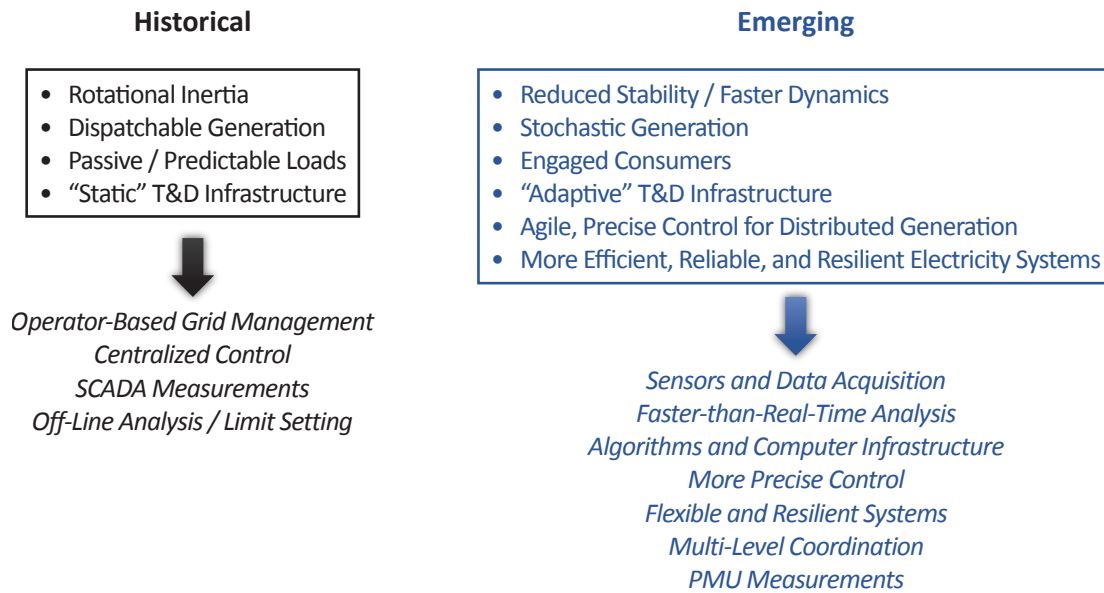
to support communication among stakeholders. Actions to develop this modern grid architecture include the coordinated advancement of standards across the electric power system, including device characteristics, communications requirements, security, and other system aspects.

Figure 3.11 outlines the various structures that the grid needs to relate to in order to provide the maximum flexibility to satisfy the required performance expectations.

The structures of the grid are already changing, requiring broader changes across the system. This, in addition to the move toward enabling prosumer participation and interaction with the grid—especially in commercial buildings, is also leading to issues in managing reliability at the distribution level and coordinating large numbers of devices and systems outside of the utility’s domain.

Consequently, the definitions of roles and responsibilities at the distribution level are changing, leading to both regulatory and industry changes. These changes will affect the design of key technologies such as protection and control systems and information and communications technology systems. At the same time, in some parts of the country, electric power systems are converging with natural gas systems, electric transportation systems, and social networks—which all impact grid control and communication. Energy storage may help to balance supply and demand and better integrate a changing generation mix, but will require a control architecture that optimally integrates storage as a resource. Critical changes are needed in the structure of controls systems, coordination frameworks, communications, and overall industry structure. It is critical that these changes be viewed, understood, rearchitected, and managed simultaneously, as these systems are deeply interconnected.

Figure 3.12 Fundamental Changes in Power System Characteristics



### 3.2.4 Moving Toward a Modern Electric Power System

The changing grid environment not only places new requirements on electric power systems, but also changes their intrinsic behavior (see Figure 3.12). Simply put, as generator and load characteristics change, the operational performance of the broader power system will be affected. Understanding these operational characteristics is integral to identifying the RDD&D needed for modern power systems.

**More precise control of the electric power system is needed to manage the changing generation mix.** Lower natural gas prices have increased the adoption of typically lightweight, fuel-efficient, and fast-responding natural gas generation, while some coal-fired plants have retired.<sup>30</sup> In addition, economics and policy have driven the adoption of renewables on both the transmission and distribution system. This shift from large, synchronous units to a mixture of lightweight, variable, and non-synchronous generators, along with changing load, has affected the rotating mass (i.e., inertial response) used to help balance and stabilize the power system in response to transient effects that can follow a sudden loss of generation or a transmission line.<sup>31</sup> If load and generation are not balanced, it spontaneously creates system stability issues.

**More rapid and precise control improves stability and aids in the transition to a more resilient system with refined margins.**<sup>32</sup> As the power system evolved, significant operating margins and sufficient redundancy were added to address uncertainty and reduce the risk of outage. The operating context has now changed, and the use of larger operating margins and reserves to reduce this risk may not be practical or cost effective. Events that were once uncommon now occur more frequently and can be potentially significant, due in part to variable renewables and changing load characteristics that are having a greater impact on power system behavior. Research into new risk-management strategies, along with control and planning approaches, are needed to reduce reserve margins while improving reliability and economics.

**Changing demand is also altering the behavior of the power system.** Residential, commercial, and industrial customers are becoming more involved in managing and generating electricity. Three interrelated and complementary factors contribute to this growing trend

- The increased availability of digital and control technologies
- State policies that encourage and incentivize the deployment of energy-efficiency practices and renewable energy technologies (distributed energy resources)
- Growing concerns regarding reliability, resilience, and security

**Increased use of distributed energy resources and smart controls in end-use devices provides opportunities for increased efficiency and management of contingencies or other events for improved reliability.** However, it also requires new levels of data communication and coordination deployed down through the distribution system and to the end user. Advanced metering infrastructure (AMI) technology, including interval meters, communications networks, and data management systems, are becoming more affordable and widespread. It is estimated that there will be more than sixty-five million smart meters deployed nationally in 2015.<sup>33</sup> Smart meters provide information that can help customers better manage their consumption of energy, with access to that data dramatically enhanced as a result of the Green Button Initiative. Deploying AMI with residential customer technologies, such as programmable communicating thermostats, coupled with variable, time-based rates can reduce electricity demand during peak periods, resulting in more efficient use of transmission and distribution assets. In one case, Oklahoma Gas & Electric observed up to 30% peak demand reduction for customers enrolled in its variable rate program.<sup>34</sup>

Table 3.1 summarizes key characteristics of traditional and modern electric power systems and shows the RDD&D needs for accomplishing electric grid modernization in a timely, efficient, and cost-effective manner. This table is a result of extensive collaboration between the public and private sectors. Over the last several years, DOE has conducted more than sixty workshops, peer reviews, requests for information, and other outreach mechanisms to better understand the issues and needs facing the private sector, states, and local and tribal communities in building, operating, and maintaining a reliable electric power system.

The table represents only high-level categories of needs, and the relative importance of factors will vary significantly as a result of unique local and regional conditions and environmental and economic constraints. There are significant technical challenges to address, including the need for better-performing and lower-cost technologies, tools, and techniques. A robust national RDD&D portfolio is essential for success.

### 3.3 RDD&D Needs to Modernize the Electric Power System

The transition to a modern grid will create new technical challenges for an electric power system that was not designed for today's requirements. Customers have never relied more on electricity, nor been so involved in where and how it is generated, stored, and used. Utilities will continue retrofitting the existing infrastructure with smart digital devices and communication technologies needed to enable the highly distributed, two-way flow of information and energy. Reliability, resilience, and security will remain a top priority as aging infrastructure and changing demand, supply, and market structures create new operational challenges. The drivers discussed in Section 3.1 and the technical issues in Section 3.2 create not only challenges but opportunities to advance the capabilities of today's electricity delivery system. Grid modernization requires a coordinated, well-considered RDD&D program that involves both the public and private sectors. The following subsections outline RDD&D needs for control systems, transmission and distribution components, distributed energy resources, electric energy storage, planning tools, and physical- and cybersecurity.

**Table 3.1** Moving from Traditional to Modern Electric Power Systems—RDD&D Needs

Electric systems	Characteristics		RDD&D needs
	Traditional	Modern	
Generation	<ul style="list-style-type: none"> <li>■ Centralized</li> <li>■ Dispatchable</li> <li>■ Large thermal plants</li> <li>■ Mechanically coupled</li> </ul>	<ul style="list-style-type: none"> <li>■ Centralized and distributed</li> <li>■ More stochastic</li> <li>■ Efficient and flexible units</li> <li>■ Electronically coupled</li> </ul>	<ul style="list-style-type: none"> <li>■ Planning tools</li> <li>■ Energy storage</li> <li>■ Control coordination</li> <li>■ Flexible thermal generators</li> </ul>
Transmission	<ul style="list-style-type: none"> <li>■ SCADA for status visibility (sampling, not high definition)</li> <li>■ Operator-based controls (primarily load following and balancing)</li> <li>■ Destabilizing effects</li> <li>■ Congestion, despite underutilized capacity (limited flow control)</li> <li>■ Threats/vulnerabilities not well defined</li> </ul>	<ul style="list-style-type: none"> <li>■ High-fidelity, time-synchronized measurements</li> <li>■ Breadth and depth in visibility</li> <li>■ Automatic control</li> <li>■ Switchable network relieves capacity constraints</li> <li>■ Threats are considered and risks are appropriately managed</li> </ul>	<ul style="list-style-type: none"> <li>■ Multi-terminal, high-voltage direct current</li> <li>■ Low-cost power flow controller technologies</li> <li>■ Next-generation energy management systems (EMS)</li> <li>■ Integrated planning tools</li> <li>■ Security</li> <li>■ Low-cost bulk storage</li> </ul>
Distribution	<ul style="list-style-type: none"> <li>■ Limited visibility</li> <li>■ Limited controllability</li> <li>■ Radial design (one-way flow)</li> <li>■ Floating on transmission</li> <li>■ Increasing fault currents and voltage issues stressing system</li> <li>■ Aging assets (unknown effects)</li> </ul>	<ul style="list-style-type: none"> <li>■ Enhanced observability</li> <li>■ Local, autonomous coordination</li> <li>■ Network design and two-way flow</li> <li>■ Backbone of delivery system</li> <li>■ Self-healing</li> <li>■ Active monitoring of asset conditions</li> </ul>	<ul style="list-style-type: none"> <li>■ Security</li> <li>■ Microgrids</li> <li>■ Advanced distribution management systems</li> <li>■ Distribution and asset sensors</li> <li>■ Solid-state transformer</li> <li>■ Smart voltage regulation equipment</li> <li>■ Community storage</li> </ul>
Customers	<ul style="list-style-type: none"> <li>■ Uniformly high reliability, but insensitive to upstream issues</li> <li>■ Energy consumers (kilowatt hour)</li> <li>■ Predictable behavior based on historical needs and weather</li> <li>■ Interconnection without integration</li> <li>■ Growing intolerance to sustained outages</li> </ul>	<ul style="list-style-type: none"> <li>■ Customer-determined reliability/power quality</li> <li>■ Prosumers (integrated)</li> <li>■ Variable behavior and technology adoption patterns</li> <li>■ Plug/play functionality</li> <li>■ Kept informed during outages (and before)</li> <li>■ Hybrid alternating current/direct current distribution</li> <li>■ Data access (outage/usage)</li> </ul>	<ul style="list-style-type: none"> <li>■ Single-customer microgrids</li> <li>■ Building EMS</li> <li>■ Distributed energy resource integration</li> <li>■ Security</li> <li>■ Transactive controls</li> <li>■ Behind-the-meter storage</li> <li>■ Low-cost sensors</li> </ul>

### 3.3.1 Control Systems—Transmission and Distribution

Evolving system-level challenges underscore the need for a new class of monitoring, control, and analytic capabilities. These challenges include the integration of large amounts of variable generation at both transmission and distribution levels, increased susceptibility of the system to destabilizing events, and rapidly



developing security issues. In the last few years, parallel computing techniques, inexpensive high-speed communications, advanced modeling frameworks, and wide-area coordination mechanisms have become available, and together hold the promise for faster simulation methods and more robust control approaches necessary for operating modern grid systems.

### Control Systems—Transmission

Traditional monitoring and control approaches are no longer sufficient to meet evolving needs for observability and controllability. A modern power system requires dynamic and wide-area view, fast and predictive analytics, and system-wide coordination. Table 3.2 summarizes some of these key distinctions between traditional and modern transmission system control.

**Table 3.2** Key Monitoring and Control Attributes for the Evolving Power System

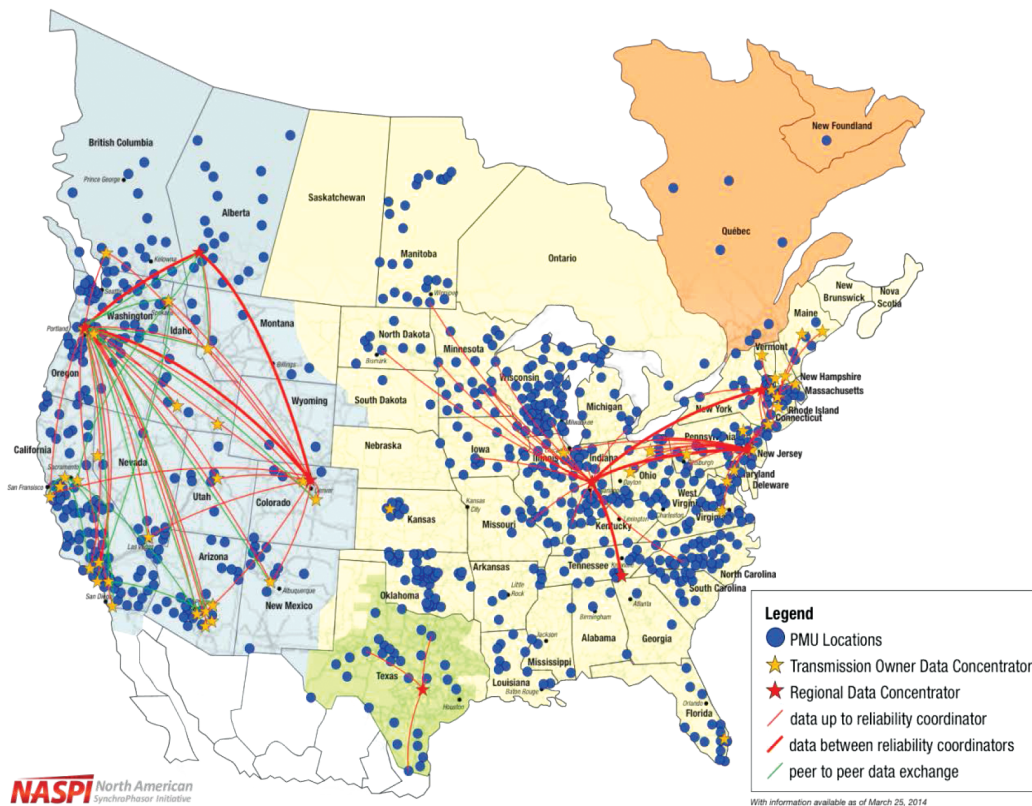
Traditional		Modern	
Observability	Controllability	Observability	Controllability
<p><b>Static, slow, and local view:</b> Weather, flows on key lines, voltages on key buses, tie flows, line status, generator status, real-power output, and predictable seasonal flow patterns</p>	<p><b>Reactive (deterministic), high-level control:</b> Balancing and load following, discretized demand response, and transmission limit determination based on simulation studies  <b>[Eliminate and/or avoid risk]</b></p>	<p><b>Dynamic, fast, and global perspective:</b> Resource forecasts, interdependencies, grid stress, grid robustness, dangerous oscillations, frequency instability, voltage instability, reliability margin, and field asset information</p>	<p><b>Predictive (probabilistic), system-wide coordination:</b> Generator coordination (dispatch and control), topology and flow control, and demand-side coordination  <b>[Manage risk]</b></p>

### Dynamic and Wide-Area View

Grid measurements from a robust network of PMUs can be used to indicate the health of the power system.<sup>35</sup> They form the foundation for advanced applications, such as wide-area situational awareness and state estimation, system dynamics monitoring, and system model validation. Communications networks (see Figure 3.13<sup>36</sup>) of varying technologies and speeds are used to transmit synchronized phasor (or synchrophasor) measurement data from the PMUs to operations centers, where the information is displayed to help operators understand grid conditions. The primary need now is for advanced software tools and platforms that can fully make use of the vast amount of information available from PMUs.

Synchrophasor data can help facilitate the integration of renewable energy into the power system.<sup>37</sup> Variable generation can cause undesirable fluctuations in system frequency if not managed properly. Real-time monitoring of the grid’s frequency with PMUs enables operators to closely monitor system conditions and take appropriate actions to maintain stability.<sup>38</sup>

To accommodate variable generation, operators must ensure that there is sufficient flexibility in the rest of the system to keep the system in balance. System flexibility can come from a number of sources, including spinning reserves, existing generator ramping capability, power flows between balancing areas, demand response, energy storage, and distributed energy resources. This highlights the need for the emerging controls approach to ensure an adequate amount of sensors are deployed along with an ability to coordinate resources across the entire power system.

**Figure 3.13** Data Flows from Transmission Owners to Regional Hubs, Between Reliability Coordinators, and Between Transmission Operators

Thousands of networked PMUs now exist across the United States and Canada, sharing operational data across wide interconnections.

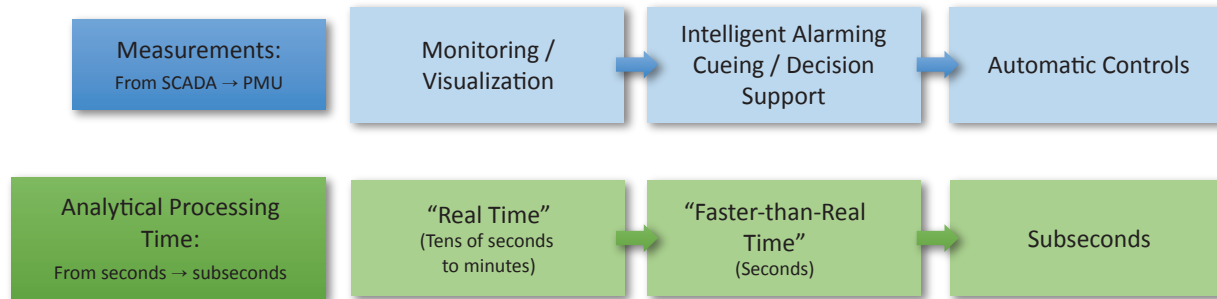
### Fast and Predictive Analytics

The need for fast and predictive analytics is further amplified by security events such as a physical attack or cyber assault on critical infrastructure. This includes links to “real-time” situational awareness tools for evaluating potential risks and contingencies (see Figure 3.14). The time it takes to analyze the situation, make a decision, and perform the system change must be faster than the interval to the next event. In the emerging operational environment of electricity delivery systems, security and observability are closely coupled. “Real-time” monitoring, analytics, and control—built on a strong foundation of measurements and models—are one key step toward detection and mitigation of these unprecedented security challenges.

The models that are essential to enhancing the operators’ understanding of system conditions and addressing situations (when complete measurement information is not available) are not developed enough to capture the emerging behavior. The visibility enabled by the new PMU infrastructure allows operators to see things they could not see before. However, there is a need to develop a cognitive model for operator behavior that captures the decision process from the human’s point of view. This forms the basis for visualization and intelligent alarming so that the operator is not overwhelmed with information, and can easily ascertain the source of the problem (and effective mitigation approaches, as appropriate).

Accelerating the analysis run time through algorithmic parallelization and model reduction/relaxation has been successfully demonstrated in the laboratory setting and holds promise for more robust control approaches and the scalability needed for future grid energy management systems. However, these time benefits are still

**Figure 3.14** Pathway to Speed Improvements in Analytical Decision Making



As measurement technologies improve, the analytical processing time also needs to be reduced, from tens of seconds to subseconds, to move from monitoring and visualization to automated controls.

constrained by the operator's ability to visualize and respond to the event, typically on the order of tens of seconds or minutes. In the near future, as the system complexity continues to grow, automated control becomes essential. This will extend to protective systems that look at coordination across the system.

### System-Wide Coordination

The traditional operating philosophy and deterministic N-1 reliability criterion—that the system must be able to tolerate the outage of any single component—may be inadequate to meet reliability and resilience objectives in this new environment. System flexibility provides the capability to manage dynamic conditions, and can come from a number of sources. The emerging control system must coordinate resources across the entire system, from load to balancing area. Broad coordination adds complexity, expands the number of control actions to be considered, and further reinforces the need for enhanced scalable functionality to support decision making. This coordination extends to operations planning—unit commitment, fuel scheduling, interchange scheduling, day-ahead markets—and the optimization algorithms, models, and tools needed for these functions. In the near future, operators will no longer be constrained to the generator, including load frequency control and economic dispatch, as a primary means to balance the broader power system. Connectivity to the distribution network, as well as to the consumer through smart appliances and demand-response programs, will expand the options available to achieve reliability and complement the benefits of interregional transmission capacity.

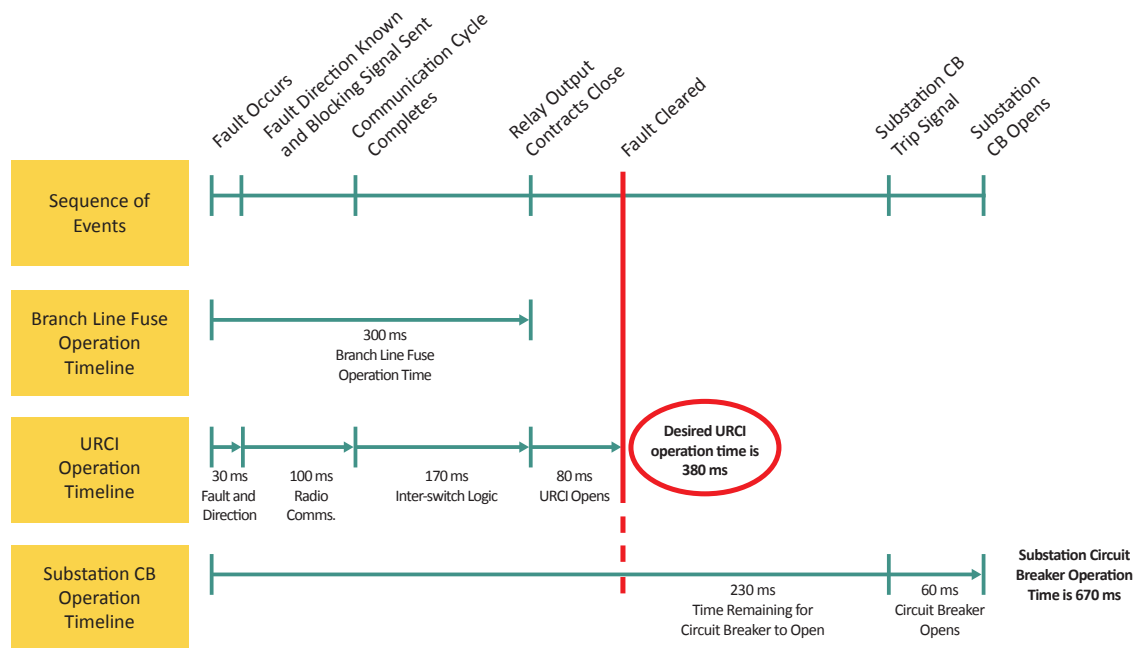
### Control Systems—Distribution

#### *Deep and Comprehensive Visibility*

Currently, most distribution system operators have limited visibility into the conditions and state of the system, except for assets at a distribution substation. However, many utilities can monitor assets along the distribution feeders and control switches remotely after disturbances. As more distributed energy resources are deployed, visibility deep into the system (e.g., along a feeder to a utility meter and possibly beyond) will be needed to ensure reliability and power quality, as well as to enable advanced applications. The installation of approximately 50 million smart meters, covering 43% of U.S. homes, has been a tremendous advancement in improving distribution visibility and helping identify customer outages before customers call to complain. However, phenomena associated with system dynamics and protection require fast, high-resolution sensors that can inform operations on the order of milliseconds (see Figure 3.15), which outlines fault clearing duration for various protective devices.

**Figure 3.15** Times Associated with Clearing a Fault (URCI = Universal Remote Circuit Interrupter)<sup>39</sup>

Credit: Southern California Edison Company



High-resolution sensors are needed, as system protection and fault clearing require action to be taken in milliseconds.

Because of the size of the distribution system, high-resolution sensors will need to be low cost for broad deployment. Micro-synchrophasors, or distribution PMUs, are one technology that can provide the enhanced visibility needed for the future grid. Other technologies include sensors that provide configuration and/or real-time condition information on field assets. Advanced applications using the sensor data can help map and update the topology of distribution systems, determine asset health, enable “real-time” distribution operations, strengthen the physical-cyber posture, and accelerate post-event recovery. It is also necessary to ensure that secure and low-latency communication channels (e.g., private or public) are available to handle the new data streams. Communications and data management requirements such as transfer rates, latency, accuracy, and storage must link to applications.

#### *Distribution Automation and Outage Management*

Utilities are adopting information and communication technologies to optimize operations and support decision making to improve system performance. Coupling high-resolution data streams with computational advances will enable faster, predictive capabilities. As the distribution system becomes more complex with more points of control and load becomes less predictable, new technologies and tools will be needed to help operators interpret data, visualize information, predict conditions, and make better and faster control actions to ensure reliability and safety.

Fault location isolation and service restoration, or “self-healing,” is an application that combines automated feeder switches with either distributed or centralized intelligence to clear faults and improve system reliability. Another application of distribution automation is Volt/volt-ampere-reactive optimization (VVO). Measurement data are coupled with intelligence to actively control distribution devices to meet the reactive power needs of loads while maintaining voltage limits to improve power quality. Conservation voltage reduction, an extension of VVO, has been demonstrated to improve system efficiency. By optimizing the voltage, it is possible to reduce

energy consumption by 5%–10% and achieve peak power reductions from 1.0%–2.5%.<sup>40</sup> Future opportunities include integrating distributed energy resources, such as smart loads, smart buildings, microgrids, and other technologies, for VVO and advanced applications.

### Coordination and Control of Distributed Resources

Demand-response programs have been offered by utilities since the 1970s to reduce peak loads during times of system stress and to keep monthly demand charges down. The coordination and control of these resources was managed by the utility through direct control or voluntary requests to certain customers for a financial incentive. Connectivity and integration of distributed resources with system operations poses significant challenges.

The potential orders of magnitude increase in points of control introduced by customer participation is shown in Table 3.3. Recent experiences with the aggregation of demand response resources into electricity market structures presents a potential framework for coordination of distributed energy resources. However, the physical constraints imposed by current distribution system designs will require careful consideration of safety, reliability, and power quality implications. The coordination and control of distributed resources will be highly dependent on the availability of intelligent devices, communication infrastructure, and distribution automation capabilities. While the impacts of distributed energy resources (DER) integration are just now beginning to surface in high-penetration regions, there is a trend toward increased DER deployment that will require improved integration and control capabilities. It also requires improved understanding of customer electricity service needs, behavior, and direct customer benefits (such as improved comfort or preventive maintenance of electrical equipment). If automated demand response, for example, can be advanced with less compromise in service to consumers, the likelihood of higher customer participation—and therefore more response for the grid—increases.

As the number of active customers grows, centralized command-and-control dispatch may become impractical. Additionally, because most of the assets are owned by consumers and third-party service providers, coordination with grid operations needs to appeal to the owners' self-interest (e.g., rewards for their participation). New coordination and control concepts are needed to achieve optimization over multiple-actor objectives, which can be synergistic or competing, and both local and system needs.

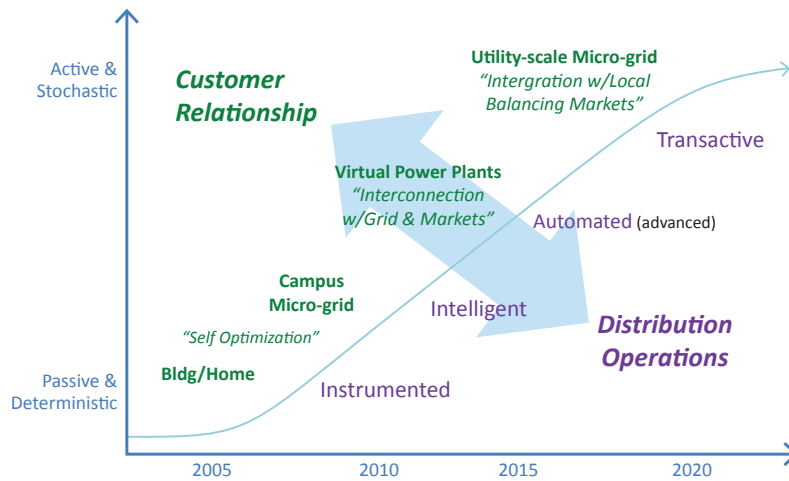
Transactive energy is an advanced concept that could contribute to the optimal balancing of supply and demand at all levels of the grid. Through the use of signals that include the cost of energy, operations, and customer-defined value, customer and third-party assets can compete or exchange for the provision of grid services and coordinate with grid operations. The evolution of this control concept is shown in Figure 3.16.<sup>42</sup> Customers begin with self-optimization and intelligent coordination with the distribution operator. As participation

**Table 3.3** Estimated Number of Nodes/Control Points per Entity Type <sup>41</sup>

Entity type	Number of nodes
Regional	<20
Control area	~200
Distribution	~1,500
Market participant	~500
Supply	~10,000
Building	~150,000,000

**Figure 3.16** Stages of Adoption of Transactive Operations for Industry

Credit: The GridWise Transactive Energy Framework is a work of the GridWise Architecture Council



As the customer relationship moves from being passive and deterministic to active and stochastic, distribution operations must also advance to optimally balance supply and demand among multiple participants.

signals, and the assets must be capable of negotiating and transacting a range of market-driven energy services with the grid and each other. Before this concept can be realized, the theoretical foundation for combining economics with scalable system controls (while still ensuring robustness and stability) must be established.

### 3.3.2 Transmission and Distribution Components

The primary objectives for next-generation transmission and distribution components are improved performance, reliability, and affordability. Improved situational awareness and monitoring can enhance asset maintenance and maximize their utility. However, emerging grid challenges and the desired capabilities in the future grid will require new hardware solutions. For example, increased deployment of distributed generation and improvements in energy efficiency are making it more likely that there will be instances where electric power is injected from a customer premise back into the distribution system. This reverse power flow can result in excessive heating of distribution transformers, as shown in Figure 3.17,<sup>43</sup> and potentially reduce the lifespan of a transformer.

Opportunities exist to improve current designs and leverage advances in new materials such as wide-band gap semiconductors, magnetics, insulators, and nanotechnology (e.g., nanostructures, nanoengineering) to increase performance. New component technology requirements will need to balance improved functionalities that support greater consumer self-generation, improve resilience, and increase flexibility while managing total costs.

#### Advanced Transformers

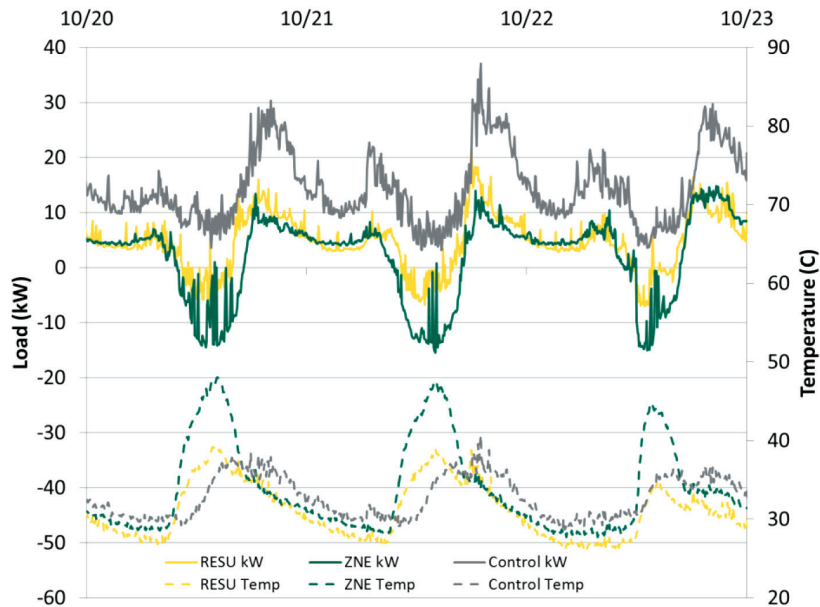
Transformers are one of the fundamental building blocks of today's electric grid, with every kilowatt-hour (kWh) of electricity delivered flowing through at least one. Large power transformers (LPTs) are mature technologies that are designed to be extremely reliable and highly efficient. Distribution transformers are also

becomes more numerous, active, and geographically dispersed, automation and fully transactive distribution operations will be needed to maintain cost-effective grid operations. This could include advancements in distributed optimization and control.

For this concept to work, the signal must be transparent and reflect the true value of the asset's contribution at all levels of the grid for all relevant value streams. Additionally, these signals must be communicated to the various distributed assets, the assets must have local intelligence and control capabilities to respond to the opportunities presented by these

**Figure 3.17** Excessive Transformer Heating from Reversed Power Flows

Credit: Southern California Edison Company



Key: **RESU** = residential energy storage unit; customers have storage available, thereby dampening the magnitude of power injection to the grid, resulting in less-severe temperature increases. **ZNE** = residential zero-net-energy customer; customers have the opportunity for more frequent power injection to the grid, resulting in higher temperatures. **Control** = residential control group customer.

Distributed generation may allow customers to inject energy back into the distribution grid. This reverse power flow can result in excessive heating of distribution transformers.

mature technologies, but are facing more dynamic voltage fluctuations and the potential of reversed current flows as more distributed energy resources are deployed. Understanding how these changes will impact the efficiency, lifetime, performance, design, and protection of these critical components through modeling and analysis is critical for the reliability of the future grid.

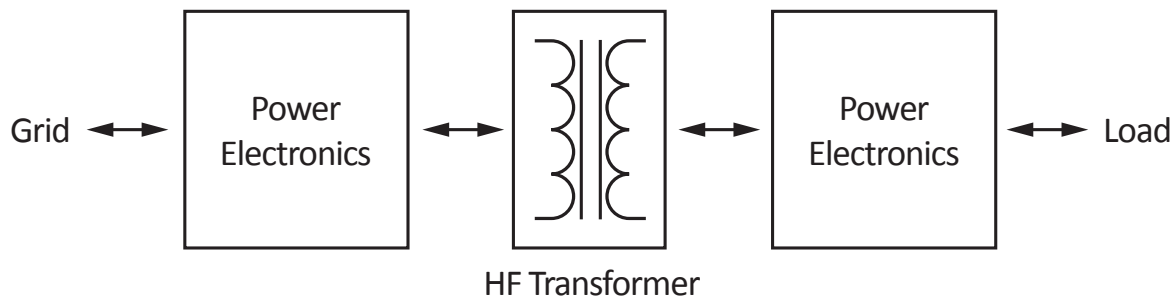
#### *Next-Generation Power Transformers*

Best-in-class LPTs can operate with up to 99.85% efficiency, but these devices are large, heavy, and expensive.<sup>44</sup> When failures occur, high costs, highly tailored specifications, lengthy production lead times, and difficult transportation and installation procedures can impact system recovery. These issues motivate the need for research in smaller, lightweight transformers that maintain or enhance reliability and efficiency. Research in core materials, winding materials, and magnetic device configuration has the potential to produce gains in this area. In addition, nearly 50% of reported LPT failures are associated with failures or degradation of insulating subcomponents, highlighting an opportunity for advanced insulators and dielectric materials.<sup>45</sup> Low-loss magnetic cores and low-resistance windings, such as high-temperature superconductors (HTS), can improve transformer efficiency. Additionally, development of new alloys can decrease the amount of iron and copper required, potentially lowering costs. To the extent possible, security enhancements should be embedded into the physical design of LPTs. Resistance to geomagnetically induced currents, electromagnetic pulses, and physical attacks should be incorporated into LPT designs.

### Solid-State Distribution Transformers

A solid-state distribution transformer (SSDT) is a design concept that combines power electronic devices and high-frequency magnetics (see Figure 3.18<sup>46</sup>) that can lead to smaller, more compact transformers and provide new control capabilities. SSDTs are not drop-in replacements for distribution transformers, but will be utilized in strategic locations for their enhanced functionality and flexibility. For instance, an SSDT can be used to mesh radial segments of the distribution network, can perform voltage regulation, supply reactive power, and be used to form hybrid alternating current (AC) and direct current (DC) systems. They can be used to manage the interaction of microgrids with utility systems, regulating the process of disconnecting and reconnecting, quickly and precisely changing the direction and magnitude of power flow, and limiting fault currents. The potential SSDT global market could grow dramatically by 2020.<sup>47</sup>

**Figure 3.18** Conceptual Diagram for Solid-State Distribution Transformer Function



SSDTs combine power electronic devices and high-frequency magnetics to lead to smaller designs.

Current SSDT designs are based on silicon insulated gate bipolar transistors (IGBTs) and face challenges associated with cost, reliability, and efficiency. Leveraging advances in wide bandgap semiconductor materials such as silicon carbide (SiC) and gallium nitride (GaN) can enable new designs and configurations that could be more cost-effective. However, significant advances in power electronic devices using these new materials are needed to achieve the high-power, high-frequency, and high-reliability requirements of an SSDT design. Trade-offs among system performance, device voltage ratings, and price must be weighed in future designs, configurations, and applications. Focused research is needed to develop new solid-state materials and components to meet these unique requirements. An SSDT can provide services in the distribution network for which current markets do not attribute a specific monetary value. This presents a difficulty in valuing the benefit of an SSDT and setting a price for competitive market entry.

### Power Flow Controllers

Electric power on the grid flows according to the laws of physics and follows the path of least resistance. During periods of high demand, bottlenecks develop on the transmission system that can prevent access to lower-cost energy resources such as wind and solar. These congestion costs can be quite significant. Greater deployment of power flow controllers can directly alleviate line congestion, increase asset utilization, and optimize generator dispatch for cost savings. Additionally, the enhanced grid flexibility can support increased penetration of variable renewable resources and improve system resilience. For example, if an area is experiencing an outage due to damaged components, power flow controllers can route power around those affected areas and continue to provide electricity to critical loads.



### *Low-Cost Flexible AC Transmission Systems*

Flexible AC transmission systems (FACTS) devices are a family of technologies that combine power electronic devices with capacitors and inductors to provide a range of control capabilities to the transmission and distribution system. FACTS devices can provide reactive power support, enhance voltage stability, increase power transfer capabilities, and improve system stability. As more variable renewable resources are deployed, these dynamic control capabilities will become more important.<sup>48</sup> The cost associated with the use of power electronic devices limits the situations in which FACTS devices are utilized. Further research geared toward new system designs and advanced power electronic devices can help to bring costs down to \$10–\$40/kVAR, making the technology competitive with other methods of power flow and voltage control.

Traditionally, FACTS installations have been large projects, comparable to substations in physical size and cost. Research efforts geared toward enhancing modularity and scalability will enable lower-cost, lower-capacity FACTS devices to be coordinated in their use. These distributed FACTS devices can address system changes, growth, and expansion in a way that is cost effective. Though several devices have been proposed, enhanced system visibility and control algorithms are required to effectively coordinate the actions of these devices.

### *High-Voltage Direct Current Converters*

High-voltage direct current (HVDC) converters can be considered a mature technology with broad deployment in transmission systems worldwide. HVDC systems have proven to be economical for transferring bulk power over long distance, for undersea applications, for isolating AC systems, and for interconnecting asynchronous networks. Voltage source converters (VSCs) based on silicon IGBTs represent a recent technological advance that provides more flexibility and simplicity in system designs. Additionally, VSCs have inherent black start capabilities, enable multi-terminal configurations, and are easier to deploy. However, this technology still faces challenges with power ratings, efficiency, and cost. Opportunities exist to improve the cost-effectiveness of VSC technology by increasing system efficiency. Reducing losses from 1.4%–1.6% per converter to 0.7% would make VSCs comparable in efficiency to the more mature line-commutated converters (LCCs) based on silicon thyristors.

Costs for HVDC converter stations can be reduced by leveraging new designs, topologies, and advanced power electronic devices based on SiC or GaN. These materials allow for higher-temperature and higher-frequency operation, which translates to smaller passive components and thermal management systems, reducing overall system costs. Additionally, new power electronic device architectures can fundamentally change the design paradigm for HVDC, because current technologies are based on vertical devices.

Research in modular multilevel converters (MMCs) can enable higher-voltage and higher-power applications, using market-available semiconductor devices. MMCs reduce stress on switching components, enhancing reliability. Multi-terminal HVDC networks (MTDC) have seen application in offshore wind collector systems, but have the potential to enhance system reliability for onshore applications as well. Controls for the coordination of MTDC terminals must be perfected before commercial systems are widely deployed. Medium-voltage direct current converter applications, such as improving resilience by connecting substations, increasing efficiency through DC distribution buses, and for nested or networked microgrids, are other areas that should be assessed.

## Protection Equipment

Undesirable or excessive current flows or over-voltages arising from natural events (e.g., lightning strikes, geomagnetic disturbance), normal system operations (e.g., switching surges, transients), or fault conditions (e.g., an unintentional short circuit or partial short circuit) can damage or destroy expensive grid components such as power transformers, HVDC converters, and FACTS devices. As power flows and system dynamics change and advanced technologies are deployed, the role, design, and configuration of protective equipment will need to evolve.

### *HVDC Circuit Protection*

HVDC protection systems must be enhanced to ensure reliability. Circuit breakers help to electrically isolate circuits and components under normal operating conditions or in emergency situations such as during sustained faults. While these technologies are mature for high voltage AC applications, they are not as mature for HVDC applications. For advanced multi-terminal HVDC networks to be realized, reliable HVDC circuit breakers with matching power ratings are needed. Initial research has been conducted in electro-mechanical, solid-state, and hybrid HVDC circuit breakers. However, material and design innovations can help drive down costs, increase power ratings, and accelerate technology deployment. In addition, MTDC networks require advanced methods for DC fault identification and location. Since many components within HVDC networks are in isolated, and even undersea, locations, these enhancements will aid in system protection, maintenance, and restoration.

### *Fault Current Limiters*

The maximum fault current in a system tends to increase over time due to more interconnections, existence of parallel conducting paths, and the additions of distributed generation.<sup>49</sup> Fault current limiters are devices that can limit these excessive currents in transmission and distribution networks to manageable levels. An additional benefit includes decreasing the required fault current rating of the equipment they are protecting, thus alleviating the need for expensive upgrades to handle growing fault currents. Systems based on power electronic devices can also be used to limit fault currents, but the technology is still in development.

### *Surge Arresters*

Increased use of power-electronics-based controllers can increase the power system's susceptibility to lightning strikes, over-voltages, and other phenomena if proper protections are not in place. Surge arresters operate by providing a path to ground when an undesirable voltage is reached in transmission or distribution systems. Most arresters are characterized by their ability to withstand lightning strikes, which can result in power-electronic-based systems with significant over-voltage margins, thereby increasing costs. Improving surge arresters with more dynamic abilities to withstand lightning strikes can help lower costs for future grid transmission and distribution components that use semiconductor devices. However, more detailed analysis is required to investigate the feasibility of using surge arresters for broader system protection.

## Advanced Cables and Conductors

Cables, conductors, and their connectors are as fundamental as transformers to the electricity delivery system. These components form the backbone of the grid, carrying power generated from centralized and distributed sources, along designated rights-of-way and distribution feeders, to customers. The U.S. Energy Information Administration estimates that 6% of all electricity generated in the United States is lost in transmission and distribution equipment.<sup>50</sup> These technologies can be improved by leveraging material advances and improved designs. These enhancements will also need to consider manufacturability to manage costs.

### *Overhead Conductors*

Overhead transmission lines are typically aluminum conductors reinforced with steel for added strength and are designed to operate at rated power/thermal levels. While carrying high currents, resistive heating will increase operating temperatures, leading to sagging. Excessive conductor sagging can result in safety hazards and increase the risk of power failures if the line contacts another object. Innovations that exhibit lower resistance, are stronger and lighter, and have better thermal management can improve the performance of overhead conductors. New materials such as ultra-conductive copper are projected to produce a 50% reduction in resistivity while simultaneously increasing strength and thermal conductivity.<sup>51</sup> Other innovations, such as coatings, to reduce corrosion, minimize icing, and increase heat dissipation can also extend the lifetime of overhead conductors.

### *Underground Cables*

Underground cables are more complicated and expensive than overhead conductors, as they need insulation, shielding, and a way to dissipate heat, and are costly to install. By reducing the conductor resistivity, more power can be delivered through similarly sized cables. For example, cables that use HTS wire can transmit up to ten times more power than conventional cables or can carry equivalent power at much lower voltages.<sup>52</sup> However, the use of this technology is limited because of the high costs associated with HTS systems. In addition to innovations for the conductor, advances in cable insulating materials can improve power rating and help dissipate heat more quickly to increase capacity. Embedded sensors and new installation techniques can also improve system maintenance and lower costs.

### *Advanced Connectors*

Connectors provide the necessary mechanical and electrical coupling between adjacent power line segments. Power transmission capacity can be limited by the connector-conductor contact resistance, and disruption can occur if the conductors pull out. Advances in connector design, surface modification to reduce oxidation, and improvements in contact strength and electrical resistance can enhance system performance. Integration of sensors to monitor connector conditions can also increase system reliability and reduce the maintenance costs.

## **3.3.3 Distributed Energy Resources**

Increased deployment of distributed generation, electric vehicles, and other new customer-sited technologies introduces operational challenges, but also presents opportunities if they are well integrated into system operations. Decentralized control paradigms and distributed approaches for the provision of grid services will need to be designed to ensure that each distributed energy resource can maximize customer benefit while providing safe and secure system integration. By leveraging advances in the design of individual devices, improved control methodologies, and telecommunication infrastructure, it is possible to use these distributed energy resources to help achieve system goals, address emerging phenomena, and provide system flexibility.

### **Grid-Enabled Customer Resources**

Grid-enabled customer resources are individual technologies connected at customer premises (within a building, campus, or industrial plant downstream of a utility meter) that can be used to provide services to the asset owner or to the grid. These technologies can be characterized as enhancements made to discrete loads, distributed generation, and other customer-owned technologies to enable connectivity and responsiveness to grid operations. Development of “smart” devices focuses on embedding local intelligence, communications, and control capabilities, which may be addressable by a utility or third party, or may be fully autonomous.<sup>53</sup> Advancing these technologies from communication-enabled resources to seamlessly integrated resources will require inherent cybersecurity, broad interoperability, proper characterization, and development of validated models.

### *Smart Loads*

There are many opportunities to make a variety of loads more “grid-friendly.” Automated responsive equipment can be designed to detect voltage and frequency or respond to signals from control systems. However, challenges remain with ensuring that these loads will be capable of providing grid services without jeopardizing the quality and reliability of their primary function. Smart loads may include building or industrial control systems that are optimized for individual services, such as lighting, heating, cooling, ventilation, pumping, and processing, but can also interact with utility or operator signals. A large opportunity exists for communications-enabled thermal energy storage systems (hot and cold), such as electric water heaters, that can provide enhanced system flexibility. Advancing smart loads will require consideration of how efficiency improvements will need to be optimized with the provision of grid services.

### *Smart Distributed Generation*

Current interconnection standards require distributed generation to disconnect when system voltage or frequency deviates from normal parameters in order to protect power system equipment and ensure the safety of line workers. Abnormal voltage and frequency conditions typically occur when contingency reserves are needed, such as when a large generator is tripped or a transmission line is disconnected. In these situations, the automatic loss of significant distributed generation can actually exacerbate the initial problem. To prevent contributing to system instability during a disturbance, smart distributed generation technologies will need to meet new operational requirements and functionality. Smart solar PV inverters have been developed to mitigate some of these challenges, but coordination with distribution system operations remains a gap. Other distributed generation resources such as back-up diesel generators, combined heat and power systems, and fuel cells can also have capabilities enabled to provide automated or coordinated control to support grid operations.

### *Smart Electric Vehicles Supply Equipment*

The projected increase in deployment of electric vehicles presents a unique challenge and opportunity for the grid. These moving “batteries” can result in very large system loads when charged in coincidence with the evening peak of residential distribution networks. Development of smart electric vehicle supply equipment can enable electric vehicles to participate in utility demand-response programs or other load-management schemes to support grid operations.<sup>54</sup> Other technology options being pursued include embedded communication and control capabilities in the electric vehicles themselves to provide grid services and vehicle-to-grid applications where the electric vehicle can serve as a source of power. As with other loads, the challenge remains with characterization, modeling, and optimizing the primary function of the technology, namely transportation, with the support of grid operations.

## **Integrated Systems**

As the number and types of smart technologies expand, they will likely grow into integrated systems consisting of multiple grid-enabled customer resources that operate as a single group. These technologies are characterized by coordination of and optimization between various individual distributed technologies—through advanced measurement, communications, modeling, and controls—that provide energy and grid services upstream of a utility meter. Integrated system technologies require close coordination with distribution control systems and present unique challenges in terms of value proposition, regulation, and operation, especially with multiple actors and multiple objectives.

### *Smart Buildings*

Buildings consume roughly 74% of total electricity and 50% of total natural gas production. This realization presents the opportunity for increasing energy efficiency, meeting customer needs and comfort levels, and supporting grid operations simultaneously. Residential and commercial buildings, as well as industrial plants,

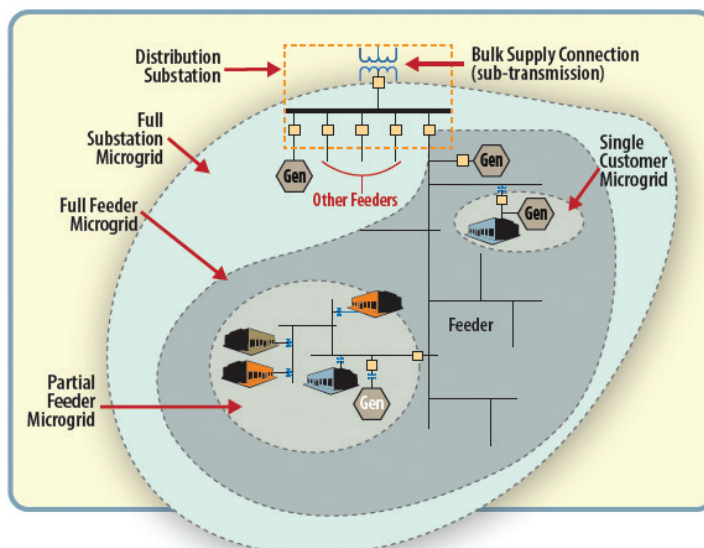
consist of many physical assets that can be regarded as an energy ecosystem. From power sources (distributed generation), to loads (appliances and machines), to storage (batteries and thermal energy), and controls (building energy management systems), buildings and industrial plants can have all the components that form an integrated electric power system.<sup>55</sup> However, communication and control capabilities are limited between these various assets, and interoperability standards are yet to be developed. This results in numerous proprietary control and communication standards developed by independent manufacturers. Proper characterization, improved interoperability, and new controls, are required to enable the optimal coordination of electrical resources housed within buildings and industrial plants.

### Microgrids

A microgrid is a group of interconnected loads and distributed energy resources within clearly defined electrical boundaries that acts as a single controllable entity with respect to the grid. It can connect and disconnect from the grid to enable it to operate in both grid-connected or island mode and can be nested one within another, as shown in Figure 3.19.<sup>56</sup> Microgrids deployed today are generally facilities with generation, such as large university campuses and military bases, or hospitals. A smart building that can island and reconnect to the distribution system would be considered a microgrid as well. One rapidly increasing role of microgrids is the shift from niche applications (e.g., energy surety) to the provision of services and benefits from the management of multiple distributed energy resources, such as electric storage, rooftop solar PV, and electric vehicles, in conjunction with building loads. Challenges exist in the development of more complex controllers for microgrids, exploring the benefits of DC microgrid designs, and coordinating nested and networked microgrids with each other and with other distributed energy resources.

**Figure 3.19** Different Microgrid Configurations

Credit: Sandia National Laboratories



Microgrids can exist in multiple configurations: independently, networked along a feeder, or nested within another.

### 3.3.4 Electric Energy Storage

Electric energy storage technologies are characterized by their bidirectional response capability to store and discharge electric power on command. These technologies can provide various benefits to the grid, such as supporting system balance, improving economic dispatch, enhancing power quality and stability, and deferring infrastructure investments. Certain electricity storage technologies can also be deployed in communities or behind the customer meter to contribute to emergency preparedness and resilience. The future grid will likely require a substantial deployment of electric energy storage to provide system flexibility and enhance control capabilities.

Pumped hydro storage (PHS) is the predominant source of grid storage today, accounting for more than 95% of storage deployed in the United States. However, siting constraints, environmental concerns, and cost make new, large-scale deployments difficult. With increasing penetration of variable renewable resources, needs for

increased operating reserves are expected, which energy storage technologies can fulfill. There are many electric energy storage technologies available, and each has its own distinctive performance characteristics that make it generally more suited for particular grid applications, as illustrated in Figure 3.20.<sup>57</sup> The applicability of a technology can be primarily determined according to its power rating and energy capacity, which are typically related as a function of time. Other technical characteristics to consider are round-trip efficiencies, cycle life, depth of discharge, and ramp rates.

One of the major challenges common across the various technologies is cost, which includes all subsystem components, installation, and integration costs. While there is a strong focus on reducing the cost of the “energy storage” component, such as battery chemistries or the spinning mass in a flywheel, this component only constitutes approximately 30%–40% of the total system cost. A total systems approach is needed to reduce balance-of-system costs and achieve the desired cost and performance targets in Table 3.4. Other common challenges include improving the safety of these technologies and assessing the appropriate value streams for the multiple services electric energy storage can provide.

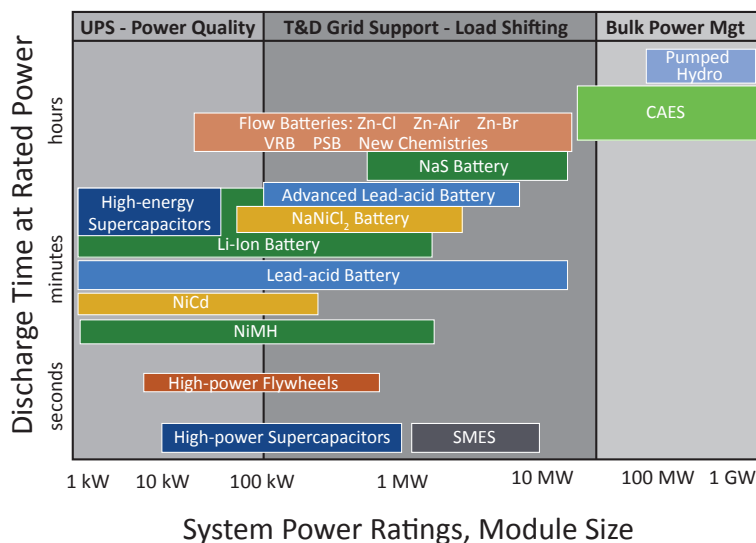
### Bulk Energy Storage Technologies

Bulk energy storage technologies are characterized by large storage capacities and long discharge times that are generally used to shift large amounts of electricity. PHS and compressed air energy storage (CAES) are two technologies capable of discharge times in tens of hours to days with power ratings that can reach 1,000 MW or more.<sup>58</sup> PHS is a mature technology currently used at many locations in the United States and around the world,<sup>59</sup> while only two operational CAES plants exist worldwide, with one in Alabama and the other in Germany.

Feasibility studies indicate PHS projects may be practically sized up to 4,000 MW and currently operate at about 76%–85% efficiency, depending on design. New capabilities of PHS, through the use of variable speed pumping, are opening up the potential for the provision of additional services to increase system flexibility. New turbine designs, optimized operations, and better controls can increase the efficiency of PHS.

**Figure 3.20** Applications of Electric Energy Storage Technologies

Credit: Sandia National Laboratories



Energy storage technologies have distinct performance characteristics that make them suited for particular grid applications.

Greater deployment of cavern-CAES technology is limited because it requires a solution-mined salt dome, a relatively rare geologic formation, in which to make sealed caverns to store the pressurized air. Porous media-CAES (PM-CAES) does not require this kind of geologic formation, making the opportunity for this technology significantly larger. As more natural gas reservoirs are depleted, PM-CAES can leverage these reservoirs, which have already demonstrated storage integrity. Fundamental research is needed for PM-CAES to understand the impact of air storage on surrounding geologic regions, as well as full system designs.

**Table 3.4** Cost and Performance Targets for Electric Energy Storage Technologies

<b>Range of baselines</b>	<b>System capital cost by energy:</b> \$805–\$10,020/kWh <b>Levelized cost:</b> \$0.01–\$0.64/kWh/cycle <b>System efficiency:</b> 75%–92% <b>Cycle life:</b> 4,500–225,000 over life of plant <b>System capital cost by power:</b> \$300–\$4,600/kW
<b>Near-term targets</b>	<b>System capital cost by energy:</b> less than \$250/kWh <b>Levelized cost:</b> less than \$0.20/kWh/cycle <b>System efficiency:</b> more than 75% <b>Cycle life:</b> more than 4,000 cycles <b>System capital cost by power:</b> less than \$1,750/kW
<b>Long-term targets</b>	<b>System capital cost by energy:</b> less than \$150/kWh <b>Levelized cost:</b> less than \$0.10/kWh/cycle <b>System efficiency:</b> more than 80% <b>Cycle life:</b> more than 5,000 cycles <b>System capital cost by power:</b> less than \$1,250/kW

## Battery Technologies

Batteries are a broad family of devices that store and release electric energy through electrochemical reactions. Battery technologies have been successfully deployed in both distributed and centralized applications in various sizes and can be used for both energy and power applications. However, they have not yet realized widespread deployment because of challenges in energy density, power performance, lifetime, charging capabilities, safety, and system life cycle cost, inclusive of waste and disposal. Many different battery chemistries and designs under investigation can be leveraged to meet cost and performance targets. For example, metal-air batteries such as zinc-air or lithium-air provide the opportunity for high energy densities and low costs because only one electrode is required. While there are many battery technologies in the market today, the scalability and technical potential for new battery chemistries and designs will continue to drive innovation.

### *Lead Acid Batteries*

Lead acid batteries are a low-cost and mature technology. However, utility-scale deployments have been limited because of their weight, large volume, cycle-life limitations, and maintenance needs. Advanced lead-carbon batteries exhibit high charge and discharge rates with no apparent detrimental effects like those typically experienced with traditional lead acid batteries. Advanced lead acid systems with design and material innovations can lead to a low-cost option for grid applications.

### *Sodium-Sulfur Batteries*

Sodium-sulfur (NaS) batteries are a commercial technology with several demonstrated grid applications. NaS batteries have significant potential for broader use because of long discharge times (~six hours), relatively high round-trip efficiencies (~75%), and quick-ramp rates. There are opportunities to improve this technology by lowering operating temperatures and exploring new sodium chemistries.

### *Lithium Ion Batteries*

Lithium-ion (Li-ion) batteries have emerged as the fastest-growing technology for electric energy storage. By leveraging the commercial availability for consumer electronic applications, Li-ion is now being positioned as the leading platform for plug-in hybrid electric vehicles (PHEVs) and all-electric vehicles. Transportation applications use large-format cells and packs with energy capacities of 15–20 kWh for PHEVs and up to 85 kWh

for all-electric vehicles. These packs can be integrated into systems for grid applications that require less than four hours of energy storage capacity. Li-ion systems dominate the current deployment landscape for grid-scale electric energy storage in the United States. However, there are many Li-ion chemistries that exist (e.g., lithium-sulfur), each with different power-versus-energy characteristics that can be explored for new system designs.

#### *Flow Batteries*

Instead of solid electrodes and a liquid electrolyte in typical batteries, the electrodes are liquid and the electrolyte is a solid in flow batteries. This configuration provides the unique ability for the energy storage capacity to scale with the volume of the liquid electrode, independent of the power rating, making this technology extremely flexible. Additionally, flow batteries have several advantages over traditional batteries, including deep discharges, high cycle-life, and extremely long unit life. However, flow batteries face challenges with low energy densities and integrated design requirements.

The most mature flow battery is based on a vanadium chemistry that suffers from cost, toxicity, and corrosive limitations. Research can help to determine the environmental risk factors of vanadium and to improve energy densities of the chemistry. Opportunities for less expensive alternatives to vanadium include chemistries based on organic chemicals such as quinones. Other chemistries such as iron-chromium, zinc-bromine, and zinc-iodide can provide system-level advantages such as simpler designs, higher energy densities, and the use of more Earth-abundant materials for reduced costs.

#### *Power Technologies*

Power technologies can be charged and discharged relatively quickly, but they tend to suffer from limited energy storage capacity. These technologies are often used in applications such as frequency regulation, power quality, and as an uninterruptible power supply.

#### *Flywheels*

Flywheels are commercially available technologies that store energy in a spinning mass called a rotor. Electric energy is converted to kinetic energy and converted back through the use of a bidirectional power conversion system. Flywheels exhibit excellent cycle-life compared to other technologies with estimates in excess of 100,000 full charge-discharge cycles. Other benefits include low maintenance, long life spans of up to twenty years, and no toxic components.<sup>60</sup> Opportunities for advanced designs and new materials can lead to reduced friction and increased rotor strength, improving efficiencies and energy capacity.

#### *Superconducting Magnetic Energy Storage*

Superconducting magnetic energy storage (SMES) is a commercial technology that stores electric energy in a magnetic field generated from a DC current circulating in a superconducting coil. SMES has the highest round-trip efficiency of any electric energy storage technology, but they are costly to manufacture and maintain. Additionally, the refrigeration system needed for the superconductor introduces large parasitic losses. Use of superconducting materials with higher-operating temperatures and efficiency improvements in refrigeration systems could lower total system costs.

#### *Electrochemical Capacitors*

Capacitors store electricity directly as electrical charge rather than converting the energy into another form (e.g., chemical energy in batteries, kinetic energy in flywheels). This principle makes the energy storage process fast, reversible, and efficient. Capacitors also have little degradation in performance over time, increasing reliability. Currently, electrochemical capacitors can store significantly more energy than dielectric and electrolytic capacitors, but are cost prohibitive. Developments in materials such as composites and nanoparticle coatings that combine low resistivity, high capacitance, and low costs could lead to next-generation electrochemical capacitors.<sup>61</sup>



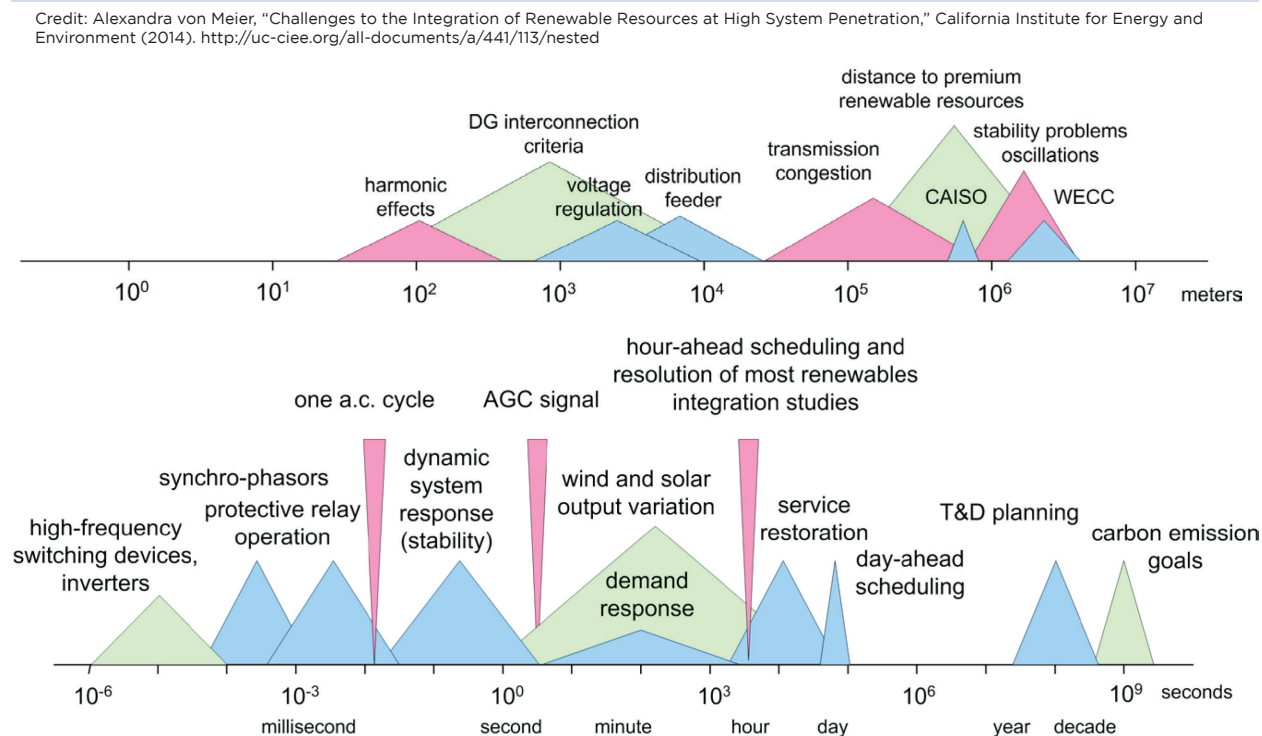
## Hydrogen Energy Storage Systems

Hydrogen energy storage (HES) systems typically involve the production of hydrogen from electricity via electrolyzers in which electrical energy is used to split water molecules into hydrogen and oxygen gas. This hydrogen can be stored or used in other sectors such as manufacturing, transportation, or end use. Running stored hydrogen through fuel cells or a combustion generator can produce electricity, reversing the process. Some life cycle cost studies indicate that HES systems can be competitive with battery systems and could be a viable alternative to PHS and CAES for bulk energy applications.<sup>62</sup> However, advances will be needed in the development of these systems to address high costs; low round-trip efficiencies; safety concerns; and the need for high-volume, high-pressure storage tanks.

### 3.3.5 Planning Tools

As the nation transitions to a modern grid, advanced planning tools and simulators will become critical to making well-informed decisions regarding system changes and infrastructure investments. From transmission expansion and production cost modeling to component designs and protection schemes, these tools are used to study various aspects of the grid and assess trade-offs between choices. Figure 3.21<sup>63</sup> depicts the spatial scale (from an individual solar panel sitting on a rooftop to the entire North American continent) and the temporal scale (from microseconds to decades) over which planning tools are needed to support decisions that have significant implications. For example, planning tools help determine operating limits and the amount of reserves needed for a particular region. Inaccuracies can lead to conservative limits that raise system operating costs or improper settings for protection schemes that could result in wide-area disturbances.

**Figure 3.21** Scales of Power Systems Operations and Planning



Planning tools are needed to support decisions over a large range of spatial scales (from an individual solar panel sitting on a rooftop to the entire North American continent) and temporal scales (from microseconds to decades).

The accuracy of any modeling or simulation result is limited by the availability and accuracy of data, the accuracy and precision of underlying models, assumptions used, computational capabilities available, and run times. Advancements in planning tools and simulators will need to address these various facets to help stakeholders evaluate the merits of technology, policy, regulatory, and market options. The growing interconnectivity, interdependencies, and complexity of the electric power system are also requiring tools with enhanced modeling capabilities.

### Improved Models and Simulators

Development of high-fidelity modeling and simulation tools can improve the accuracy of grid planning, operations, and decision making. Many recent innovations can be leveraged to capture and better reflect observed phenomena. For example, the availability of high-resolution sensors (e.g., PMUs) can be used to validate models, and advanced computing platforms (e.g., parallel processing) can be used to accelerate run times. Additionally, open-source frameworks (e.g., GridLAB-D) can be used to foster interoperability, and mathematical advancements can be used to address uncertainty and risk. If the integration of the real-world data streams can be done effectively and efficiently, models and simulators can automatically update and self-calibrate to reflect changing conditions and improve accuracy. Many of the innovations made for off-line planning tools and simulators can also be adopted or extended for use in the operational environment. As the grid transitions to one that is analytically driven and controlled, foundational improvements in operational models and simulators becomes even more critical. Validation of reduced-order models using real world data and established use cases is needed before automation and model-based control can be fully trusted. Additionally, significant amounts of information will need to be rapidly processed and fed into these models and simulators.

### Framework for Tool Interoperability

A common, systematic framework in which existing tools from disparate technical domains converge on mutual boundary conditions can help address emerging questions stemming from growing interdependencies and complexity. A prototype environment Framework for Network Co-Simulation integrates tools across multiple domains and scales.<sup>64</sup> The National Rural Electric Cooperative Association is also developing an open modeling framework based on Pacific Northwest National Laboratory's GridLAB-D. More work is needed in this area to accelerate the development and application of this environment to keep pace with the needs of the future grid. Another important aspect of tool interoperability is the development of accurate, comprehensive, and harmonized data sets that can be broadly used. Data sources that should be collected and harmonized include weather, load profiles (including composition), device models, grid asset location and specifications, generator location and performance, storm history, communications, geographic, water, and others. One major challenge in assembling data is the inconsistent naming conventions used for the same grid assets among different data sets. These discrepancies can lead to errors and limitations in modeling results. Another challenge is the costs (e.g., labor and time) associated with the collection, scrubbing, and organization of data. Mechanisms to connect offline data sets with sources from an operational environment would greatly facilitate the process.

### Decision-Making Tools

While the development of next-generation planning tools and simulators provides tremendous analytical capabilities for answering complex questions, the majority of grid stakeholders may not have the expertise to use these tools, or may have limited access to the required computational resources. Decision-making tools that are publicly accessible and user-friendly can support the transition to a future grid. These tools can also help with economic decision making by establishing a common reference for answering the often contentious

questions around valuation, costs, and benefits of particular technologies or options. Dashboards and Web-based tools that can run on desktops and are sufficiently accurate can help regulators, policymakers, energy developers, and other institutional entities quickly understand the impact of their choices. Future opportunities include developing simple interfaces that can link with the more complex planning tools and simulators to blend ease of use and analytical rigor, and leveraging cloud-based computing to permit broader access to advanced analytical capabilities.

### 3.3.6 Physical and Cybersecurity

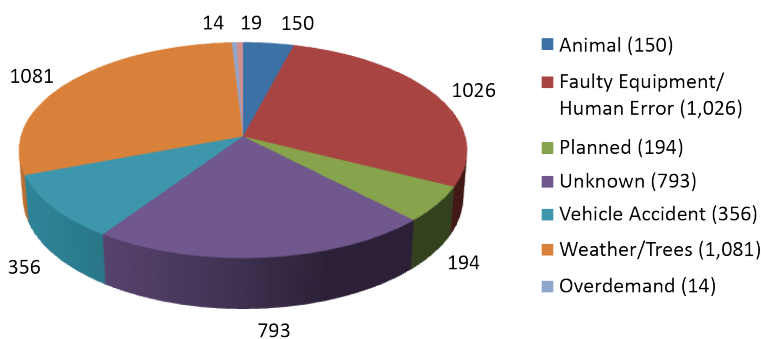
Ensuring the nation’s electric power system is adequately protected against physical and cyber threats is a shared public and private sector responsibility. While the private sector has the primary responsibility, long-term or widespread outages can have severe consequences for human health and safety and national security. Coordinated actions are needed to ensure appropriate, timely, and effective allocation of resources.

In the face of more frequent and intense weather events, along with potential for cyber and physical attacks, there are growing expectations for a resilient and responsive power system to meet not only reliability objectives, but also security concerns. The resilience and responsiveness is enabled by the introduction of information and communication technologies, and their integration with advanced and legacy devices in ways not previously envisioned can increase vulnerabilities, given the emerging threat landscape. Since 2010, the international energy cybersecurity environment has experienced an increase in cyber attacks. The sophistication and effectiveness of this new era of malware mark a significant change in state actor-level threats to the energy sector and the U.S. economy. There is also evidence that nation-states are increasing cyber-spying and attacks on U.S. utilities and equipment suppliers. These threats demand energy delivery control systems that are secure in every aspect and resilient during a cyber incident.

Simultaneously, the increased frequency and intensity of extreme weather events and potential attacks on electrical infrastructure require more careful consideration of physical security. While the Metcalf Substation attack in 2013 gained national attention because of the apparent military tactics used, attacks on electric power systems are not new. Utilities have faced physical threats from copper theft at substations to the occasional individual shooting insulators or conductors. It is important to consider that theft and vandalism rank fairly low when compared to outages caused by weather, faulty equipment, or unknown circumstances (see Figure 3.22<sup>65</sup>).

**Figure 3.22** 2014 Reported Power Outages by Eight Possible Causes

Credit: Eaton



The highest number of unplanned outages are caused by weather, faulty equipment, and unknown circumstances.

Utilities will only adopt security measures that align with their risk-management strategy. Physically hardening and protecting the entire electric power system—with more than 5,800 major power plants, 55,000 substations, and more than 642,000 miles of high-voltage transmission lines<sup>66</sup>—is impractical. Solutions that are developed will need to balance between the risks an entity is willing to accept and the risks that it must address. As threats will not go away, it is important that the future electric power system be designed and operated to be more resilient so that it can continue its critical functions after an event. It is also important that measures developed will not interfere with the energy delivery functions of the devices and components they are meant to protect.

Based on recommendations developed by energy asset owners and operators, suppliers, government entities, national laboratories, and academics,<sup>67</sup> security activities should focus on the following:

- Building a culture of security
- Assessing and monitoring risk
- Developing and implementing new protective measures to reduce risk
- Managing incidents
- Sustaining security improvements

The objective of these activities is to position the energy sector at an advantage over adversaries or natural threats and reduce the risk that an incident will result in disruption of electricity delivery.

### Cybersecurity

Cybersecurity is a serious and ongoing security, safety, and economic challenge for the electricity sector. The sector comprises organizations that vary significantly in their size, functions, capabilities, and criticality. The electric power system is mostly owned and operated by the private sector, but is critical to the nation's security. While electricity service providers address threats and vulnerabilities associated with their assets, systems, and networks on a daily basis, effective collaboration with the public sector is needed to address the scale of threats, sharing of information, and RDD&D to develop systems that are inherently resistant to disruption.

Cybersecurity in the electricity sector is often broken down into measures for systems with operational technology (OT) or information technology (IT). IT systems are typically used to support business, human resources, and other non-operational functions, whereas OT systems are typically used to transfer data and commands that are critical to operating and protecting the grid itself. OT systems differ from IT systems with regard to data availability challenges. High-speed data transfer is needed for reliable electricity operations. Protection schemes require precise timing and therefore may not tolerate the latency that might be injected by encryption or other security measures. Another challenge unique to OT systems is that patches and upgrades require extensive testing and validation to ensure that the change does not jeopardize operations. As these technologies evolve, there is also an increasing need to consider the vulnerabilities arising from the convergence of IT and OT. Some of the key parameters to guide effective cybersecurity RDD&D for energy delivery systems are shown in Table 3.5.

The North American Electric Reliability Corporation (NERC) Critical Infrastructure Protection standards provide mandatory standards for protecting the bulk power system against cyber events. These standards are enforced by the Federal Energy Regulatory Commission. No such standards exist for distribution system assets and systems.

Spurred by funding under ARRA, significant progress has been made in developing and implementing comprehensive methodologies to better protect the power system from cyber attacks. The National Institute of Standards and Technology launched the Smart Grid Interoperability Panel (SGIP). The SGIP is a public-private partnership to foster the development of interoperability and cybersecurity standards. The SGIP developed *Guidelines for Smart Grid Cyber Security*, which has been instrumental in guiding the deployment of cybersecurity protections for the smart grid.

In 2005, DOE, the U.S. Department of Homeland Security, and Natural Resources-Canada worked with the energy sector to develop the *Roadmap for Energy Delivery Control Systems Cybersecurity* (originally called the *Roadmap to Secure Energy Sector Control Systems*). The roadmap provides a guide for public and private activities to enhance cybersecurity across the energy sector with a vision for resilient energy delivery control systems that can survive a cyber incident while sustaining critical functions.

**Table 3.5** Cybersecurity R&D Parameters

<b>Time latency</b>	<ul style="list-style-type: none"> <li>■ ≤ Four milliseconds for protective relaying</li> <li>■ Sub-seconds for transmission wide-area situational awareness monitoring</li> <li>■ Seconds for substation and feeder SCADA</li> <li>■ Minutes for monitoring noncritical equipment and some market pricing information</li> <li>■ Hours for meter reading and longer-term market pricing information</li> <li>■ Days/weeks/months for collecting long-term data, such as power quality information</li> </ul>
<b>Integrity assurances</b>	<ul style="list-style-type: none"> <li>■ Data have not been modified without authorization</li> <li>■ Source of data is authenticated</li> <li>■ Timestamp associated with the data are known and authenticated</li> <li>■ Quality of data is known and authenticated</li> </ul>
<b>Confidentiality</b>	<ul style="list-style-type: none"> <li>■ Privacy of customer information</li> <li>■ Electric market information</li> <li>■ General corporate information, such as payroll, strategic plans, etc.</li> </ul>

Since 2005, DOE has been working with the electricity industry, federal partners, and academia to implement the roadmap. Significant progress has been made in using the roadmap to develop and commercialize tools and guidance. Some recent examples include the following:

- **SIEGate** (Secure Information Exchange Gateway) provides secure, flexible, real-time, and reliable information exchange for electric grid applications. It consolidates data exchange to reduce the external attack surface and costs of maintaining multiple data exchange systems.
- **Padlock** is a cybersecurity gateway device that provides strong access controls, central collection of log data, enhanced serial and Ethernet data communication security, and password management for field devices.
- **exeGuard** protects energy delivery computers from unexpected cyber activity, including attempts to inject malicious code or alter settings without proper authentication.
- **NetAPT** (Network Access Policy Tool) helps energy utilities map their control system communication paths, including for critical cyber assets, in minutes rather than days, and verifies that these paths conform to the utility's security policy.

However, many other technical advances are needed to address gaps and evolving challenges.

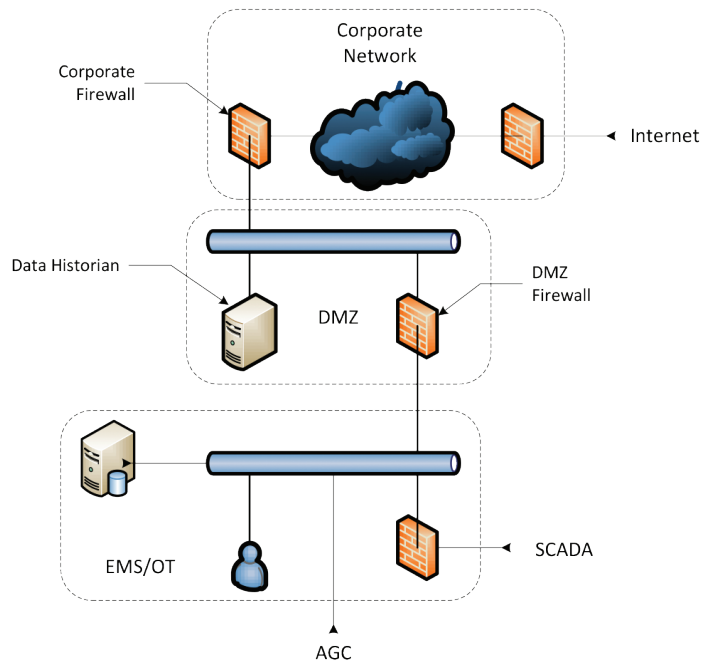
#### *Improved Situational Awareness*

As cyber and physical threats evolve, technologies and capabilities to assess the “state of security” for the grid will be needed. Cyber-physical models, analytical tools, and performance metrics can help enable this capability. Moving to real-time analytics and the ability to co-simulate cyber and physical systems are both methods that can be used to perform non-traditional contingency planning. While not used directly for operations, information on electricity prices and capacity provides a gateway that can impact power flow management. Identifying other aspects of nontraditional contingency planning, increasing the speed of detecting compromises, and improving the situational awareness of the security posture, both cyber and physical, are all important areas to investigate.

### Scalable Secure Communications

Communicating at speed with thousands (even millions) of devices is unachievable with today's technology. The use of cloud computing by the electric sector and the trend toward the "Internet of things" can support the scaling issue, but present unique challenges for cybersecurity measures. For example, the utilization of public

**Figure 3.23** Cross-Organizational Chain of Trust



DMZs segment corporate and operational networks, yet trusted communications still allow information and data to pass across domains and between organizations.

### Trusted Data Exchanges

Today utilities employ demilitarized zones (DMZs) that segment corporate and operational networks. However, electricity sector information and data are still required to be passed across domains and between organizations for efficient operations. Figure 3.23 shows a schematic of this architecture. Organizations should be able to move customer data without compromise, securely exchange corporate or operational data with other organizations if required, and be able to rely on data transfers for operations even if part of the system has been compromised by cyber attacks. Importantly, the operational networks that control electricity delivery must be designed to reject, and be resilient to, a cyber incident that may have penetrated the corporate network defenses. Cybersecurity technologies should consist of end-to-end data delivery, computation, and power applications that are able to respond jointly, quickly, and seamlessly across the various domains.

### Real-Time Investigation, Mitigation, and Recovery

Resilient control systems should be able to survive a cyber incident while sustaining critical functions and be able to "ride through" or adapt to a cyber incident. In a modernized grid, control systems should be able to operate with part(s) of the system or its component devices, including applications and data, compromised by malicious intrusion. Critical electricity delivery functions should be sustained while forensic investigations

key infrastructures may not be practical for large-scale deployments. Another aspect of secure communications is the physical security of the assets associated with the underlying IT and OT systems. Technologies that can enable manufacturing of inherently secure devices can facilitate adoption of advanced security technologies. High-performance data management techniques, and analytics that can handle the growing amount of data transfers for security purposes are other areas to investigate. Another challenge is that protocols engineered for legacy IT and OT components may not operate as intended in current computing and networking environments and are vulnerable to manipulation.

proceed to understand the extent and consequence of the compromise, followed by development of mitigations and recovery to normal operations. Another potential response to a threat is logical islanding, which extends the classical islanding concept to cyber assets, refusing or distrusting connections from peer systems that appear to be compromised or malfunctioning.

#### *Cybersecurity Capabilities and Efforts Database*

Identifying available cybersecurity capabilities is a necessity to ensure gaps in cybersecurity technology development are addressed and not overlooked. This will reduce redundancy of efforts, yet identify potential areas of overlap that would ensure greater cybersecurity. A repository of efforts currently resides on the ieRoadmap website,<sup>69</sup> which is searchable by organization and maturity. However, there currently is no capability to identify redundancies and gaps, or to have confidence that all available technology is identified.

### Physical Security

Physical security measures include activities that can harden assets, improve situational awareness, deter and respond to man-made threats, and mitigate risks. Winter storms, earthquakes, vandalism, and numerous other physical threats can be addressed through RDD&D efforts. Key needs are risk assessment tools and processes to determine the most vulnerable portions of the grid and the most appropriate solution to implement to manage costs. Efforts will require consideration of operations and the impacts of physical threats on the cyber domain, such as attacks and disruptions to critical communication channels.

#### *Smart Materials*

Many substation components are exposed because they require heat transfer to the surrounding air to maintain normal operations and may require access for maintenance. Concrete barriers may protect assets but would not prevent an intruder from walking inside the substation. RDD&D of smart materials that can be used in electrical transmission and distribution components that prevent or self-heal from damage would be valuable. Components that can benefit from smart materials include insulators (bushings and transmission line), transformers (conservators, cooling vanes, and tanks), circuit breakers (bushings and tanks), and voltage stability components (capacitors and inductors). Other smart material innovations that could be applied to transmission and distribution lines include super-hydrophobic coatings that facilitate deicing during winter storms.

#### *Operational Response to Intrusion/Damage*

Protection relays for physical components are typically set so the system will go to its safest state, de-energized, in the event a threshold limit is exceeded. These schemes occur primarily at the transmission level and are critical for reliable operations. However, if a fault occurs due to vandalism or an attack, protection relays may not be set appropriately and other components can remain energized or exceed thresholds, resulting in permanent damage. Automatic operational schemes could be armed after an intelligent adversary was detected within the boundaries of a substation or switchyard and identify resilient configurations for the remaining system to survive the loss of this particular substation. Other predictive system configurations, including adaptive relaying, topological switching, and intentional islanding with microgrids, are areas of investigation.

#### *High-Impact, Low-Frequency Events*

The electricity industry has long studied the effects of high-impact, low-frequency (HILF) events, such as risks posed by coordinated attacks, pandemics, and geomagnetic disturbance or electromagnetic pulses.<sup>69</sup> Work published by NERC in 2012 made thirty-three recommendations in the areas of operations, monitoring, communications, short/long-term system planning, protection and control, interdependencies with other critical infrastructures, and others.<sup>70</sup> Many of these recommendations currently have R&D efforts at national laboratories.

Another area that could be investigated is HILF events on other sectors or sub-sectors where the second order impact would be to the electrical subsector. Examples include inadequate transportation of fuel for electric generation such as coal by rail or constraints on the natural gas supply, such as during the recent polar vortex. As the electric power system becomes more interconnected, understanding and analyzing the impact of interdependencies from these events is a critical area of research.

### System Recovery

While cyber- and physical-security measures can mitigate and prevent the impact of incidents, there will be times when the system will fail from known or unknown threats. RDD&D into technologies and mechanisms that can accelerate system recovery are critical to improving the resilience of the grid. While improvements to control systems and distribution automation can facilitate recovery from disruptions, there are steps in the resoration process that will require human intervention, such as the replacement of damaged cyber and physical assets.

#### *Damage Assessment and Predictions*

Analysis and prediction of how a storm or an event (e.g., HILF scenarios) may damage assets in an area can facilitate preparation and prioritization of resources to respond to the event. These capabilities can be extended to include the assessment and prediction of compromised assets resulting from a cyber incident. Proper preparation, staging, and training can accelerate restoration, but advanced analytics after an event can also facilitate recovery. Opportunities exist to integrate data from various channels and sources that may be limited or incomplete to support system restoration. Examples include using social media, integrating weather forecasting with outage management systems, and considering flood and transportation models into logistics and planning.

#### *Large Power Transformer Availability*

LPTs are critical assets with lead times of thirty-five weeks or more after receipt of order. In the event LPTs are damaged, the availability and suitability of a replacement becomes the priority. Standardization of transformer specifications can reduce this lead time to approximately twenty weeks and cut costs by 15% or more.<sup>71</sup> While standardization can help system recovery of LPTs, many legacy substations face challenges from customized solutions. Industry currently has transformer-sharing programs, but opportunities exist to identify new mechanisms to ensure transformer availability. For example, retrofit of transformers from coal plant retirements can serve as a temporary supply of LPTs and could shorten the time of replacement from months to weeks for critical facilities.

#### *Portable Power Delivery Equipment*

As with transformers, damage of other critical electricity delivery assets can impact the time it takes to recover from an event. Portable power delivery equipment that can be used to help restore power to communities may be a useful area to explore. A prototype for a recovery transformer has been demonstrated and concepts of mobile substations have been explored.<sup>72</sup> While not a permanent replacement, these technologies could allow power plants to come online at a reduced capacity until an actual replacement could be manufactured, shipped, and installed. Other options for portable power delivery equipment can be explored.



### 3.4 Conclusion

The traditional electricity infrastructure has provided reliable electricity for more than a century, but today's energy requirements are rapidly changing. Changes in the supply and generation mix, evolving demand loads, and the transition of consumers to active “prosumers” are all creating technical challenges for an aging electricity infrastructure. The proliferation of new digital control and communication devices brings new opportunities for managing distributed generation and storage, but creates new security and integration challenges. Simultaneously, growing dependence on highly reliable electricity for national and economic security makes electricity resilience a top priority. A modern electric grid must be more flexible, agile, and dynamic—able to integrate and optimize a wide mix of generators, loads, and storage capabilities.

These trends create new technical requirements for the power grid and redefine its fundamental design and operational structures. Profoundly different generation and load characteristics will affect power system behavior and overall operational performance. These changes in operational characteristics help to define the RDD&D requirements of modern electric power systems (see Table 3.6).

From the technology assessments presented in this chapter, RDD&D opportunities were identified in seven high-impact areas needed to build the fundamental capabilities required for a modern electric power grid. Table 3.7 summarizes the opportunities for RDD&D to meet the technical challenges of a grid in transition.

**Table 3.6** Fundamental Changes in Power System Characteristics

Historical	Emerging
<ul style="list-style-type: none"> <li>■ Rotational inertia</li> <li>■ Dispatchable generation</li> <li>■ Passive and predictable loads</li> <li>■ Static transmission and distribution structure</li> </ul>	<ul style="list-style-type: none"> <li>■ Fast dynamics with reduced stability</li> <li>■ Stochastic generation</li> <li>■ Engaged customers</li> <li>■ Adaptive transmission and distribution structure</li> <li>■ Agile and precise control for distributed generation</li> <li>■ Highly efficient, reliable, and resilient system</li> </ul>

**Table 3.7** Summary of RDD&D Opportunities

Area	RDD&D opportunities
Grid design and interoperability	<ul style="list-style-type: none"> <li>■ Development, analysis, and refinement of grid architecture, designs, and associated structures</li> <li>■ Standards to ensure interoperability between various resources and with control systems</li> </ul>
Control systems for transmission and distribution	<ul style="list-style-type: none"> <li>■ Development of advanced software, models, and visualization tools using high-speed data from PMUs and other sensors to provide robust “real-time” monitoring, control, detection, and mitigation of system conditions</li> <li>■ New distribution-level technologies and tools to interpret and visualize data, predict conditions, and enable faster control to ensure reliability and safety</li> <li>■ Innovative control approaches to coordinate and manage distributed resources in conjunction with transmission system operations</li> </ul>
Transmission and distribution components	<ul style="list-style-type: none"> <li>■ Material innovations for high-power, high-frequency, and high-reliability grid applications, including wide bandgap semiconductors</li> <li>■ Component designs, topologies, and systems based on solid-state devices that lead to higher performance, increased reliability, resilience, and lower costs</li> </ul>
Distributed energy resources	<ul style="list-style-type: none"> <li>■ Advanced “smart” technologies (e.g., loads, generators, electric vehicles) with embedded local intelligence, communication, and control capabilities</li> <li>■ Controllers for integrated systems such as smart buildings and microgrids</li> </ul>
Electrical energy storage	<ul style="list-style-type: none"> <li>■ Materials research to lower costs, increase energy density; increase capacity; improve performance; and reduce lifetime impacts, including disposal</li> <li>■ Full system designs that address costs (e.g., subsystem, installation, and integration) along with round-trip efficiencies, cycle life, depth of discharge, ramp rates, and safety</li> <li>■ Solid-state control systems to better integrate storage in the grid</li> </ul>
Planning tools	<ul style="list-style-type: none"> <li>■ High-fidelity models, tools, and simulators that are user-friendly and accessible to decision makers</li> <li>■ Common framework for modeling and co-simulation of tools from disparate technical domains (e.g., power flow, communications, and markets)</li> </ul>
Physical- and cybersecurity	<ul style="list-style-type: none"> <li>■ Tools for nontraditional contingency planning and situational awareness of the security posture, both cyber and physical</li> <li>■ Resilient and adaptive control systems that can survive an incident while sustaining critical functions</li> <li>■ Innovative technologies to assess system trust, identify and eradicate embedded malware, and techniques to validate security of supply chain</li> </ul>

# Chapter 3: Enabling Modernization of the Electric Power System

## Technology Assessments

- 3A** Cyber and Physical Security
- 3B** Designs, Architectures, and Concepts
- 3C** Electric Energy Storage
- 3D** Flexible and Distributed Energy Resources
- 3E** Measurements, Communications, and Control
- 3F** Transmission and Distribution Components

[See online version.]

### Endnotes

- <sup>1</sup> Energy Information Administration. "Monthly Energy Review." DOE/EIA-0035(2015/05), May 2015. Available at: <http://www.eia.gov/mer>.
- <sup>2</sup> Energy Information Administration. "Annual Energy Outlook 2015 with Projections to 2040." DOE/EIA-0383(2015), Washington, DC: EIA. Office of Integrated and International Energy Analysis, April 2015. Accessed August 2015: <http://www.eia.gov/forecasts/aeo/>.
- <sup>3</sup> GridWise Alliance and U.S. Department of Energy (DOE). "The Future of the Grid: Evolving to Meet America's Needs." No. GS-10F-0103J, Subtask J3806.0002. Work performed by Energetics Incorporated, Columbia, MD: DOE, December 2014. Accessed March 27, 2015. Miller, C.; Martin, M.; Pinney, D.; Walker, G. "Achieving a Resilient and Agile Grid." NRECA, April 2014. Edison Electric Institute. "Disruptive Challenges: Financial Implications and Strategic Responses to a Changing Retail Electric Business." Prepared by Peter Kind, January 2013. Available at: <http://www.eei.org/ourissues/finance/documents/disruptivechallenges.pdf>.
- <sup>4</sup> GridWise Alliance and U.S. Department of Energy (DOE). "The Future of the Grid: Evolving to Meet America's Needs. No. GS-10F-0103J, Subtask J3806.0002. Work performed by Energetics Incorporated, Columbia, MD: DOE, December 2014. Accessed March 27, 2015.
- <sup>5</sup> International Energy Agency. "Technology Roadmap: Smart Grid." OECD/IEA. Paris, France, 2011. Accessed March 27, 2015: [http://www.iea.org/publications/freepublications/publication/smartgrids\\_roadmap.pdf](http://www.iea.org/publications/freepublications/publication/smartgrids_roadmap.pdf).
- <sup>6</sup> Electric Power Research Institute. "Estimating the Costs and Benefits of the Smart Grid. 2011. Available at: <http://ipu.msu.edu/programs/MIGrid2011/presentations/pdfs/Reference%20Material%20-%20Estimating%20the%20Costs%20and%20Benefits%20of%20the%20Smart%20Grid.pdf>.
- <sup>7</sup> Droop curves reflect the changes in system frequency on the load.
- <sup>8</sup> U.S. Energy Information Administration. "Monthly Energy Review." February 2015. Available at: <http://www.eia.gov/totalenergy/data/monthly/#electricity>.
- <sup>9</sup> California ISO. "Fast Facts: What the Duck Curve Tells Us About Managing a Green Grid. 2013. Accessed March 27, 2015: [http://www.caiso.com/Documents/FlexibleResourcesHelpRenewables\\_FastFacts.pdf](http://www.caiso.com/Documents/FlexibleResourcesHelpRenewables_FastFacts.pdf).
- <sup>10</sup> One example is as follows: Black and Veatch. "San Diego Distributed Solar PV Impact Study, July 9, 2013." Accessed March 27, 2015: <http://catcher.sandiego.edu/items/usdlaw/pv-impact-study-2013-draft.pdf>.
- <sup>11</sup> Kiefer, T. A. "Ike: Disruptions to Utility Business Models." *T&D World Magazine*, May 15, 2014. Accessed March 27, 2015: <http://tdworld.com/generation-renewables/disruptions-utility-business-models>.
- <sup>12</sup> Solar Energy Industries Association. "Solar Industry Data, December 2014." Accessed March 27, 2015: <http://www.seia.org/research-resources/solar-industry-data>.
- <sup>13</sup> U.S. Energy Information Administration. "Monthly Energy Review: February 2015." Available at: <http://www.eia.gov/totalenergy/data/monthly/>.
- <sup>14</sup> U.S. Department of Energy (DOE). "2014 Smart Grid System Report." Washington, DC, August 2014. Accessed March 27, 2015: <http://energy.gov/sites/prod/files/2014/08/f18/SmartGrid-SystemReport2014.pdf>.
- <sup>15</sup> Accenture. "Achieving High Performance in Smart Grid Data Management." 2010. Accessed March 27, 2015: [https://www.smartgrid.gov/sites/default/files/doc/files/Achieving\\_High\\_Performance\\_in\\_Smart\\_Grid\\_Data\\_Management\\_201012.pdf](https://www.smartgrid.gov/sites/default/files/doc/files/Achieving_High_Performance_in_Smart_Grid_Data_Management_201012.pdf).

- <sup>16</sup> U.S. Department of Energy. “Office of Electricity Delivery and Energy Reliability. Summary of the North American Synchronphasor Initiative (NASPI) Activity Area.” June 2012. Accessed March 27, 2015: <http://www.energy.gov/oe/downloads/north-american-synchronphasor-initiative-naspi-program-information>.
- <sup>17</sup> LaCommare, K.; Eto, J. “Cost of Power Interruptions to Electricity Consumers in the United States.” Ernest Orlando Lawrence Berkeley National Laboratory for the U.S. Department of Energy, 2006. <http://emp.lbl.gov/sites/all/files/REPORT%20lbnl%20-%2058164.pdf>. Lineweber, D.; McNulty, S. “The Cost of Power Disturbances to Industrial & Digital Economy Companies.” Prepared by Primen for the Electric Power Research Institute, 2001.
- <sup>18</sup> Executive Office of the President. “Economic Benefits of Increasing Electric Grid Resilience to Weather Outages.” Prepared by the President’s Council of Economic Advisers and the U.S. Department of Energy Office of Electricity Delivery and Energy Reliability, with assistance from the White House Office of Science and Technology, August 2013. Available at: [http://energy.gov/sites/prod/files/2013/08/f2/Grid%20Resiliency%20Report\\_FINAL.pdf](http://energy.gov/sites/prod/files/2013/08/f2/Grid%20Resiliency%20Report_FINAL.pdf).
- <sup>19</sup> U.S.-Canada Power System Outage Task Force. “Final Report on the August 14, 2003, Blackout in the United States and Canada: Causes and Recommendations.” April 2004. Accessed March 27, 2015: <http://energy.gov/sites/prod/files/oeprod/DocumentsandMedia/BlackoutFinal-Web.pdf>.
- <sup>20</sup> U.S. Department of Energy and the North American Electric Reliability Corporation. “High-Impact, Low-Frequency Event Risk to the North American Bulk Power System.” June 2010.
- <sup>21</sup> Global Environment Fund and Center for Smart Energy. “The Emerging Smart Grid: Investment and Entrepreneurial Potential in the Electric Power Grid of the Future.” October 2005. Available at: [http://assets.fiercemarkets.net/public/smartgridnews/sgnr\\_2007\\_0801.pdf](http://assets.fiercemarkets.net/public/smartgridnews/sgnr_2007_0801.pdf).
- <sup>22</sup> Monitoring Analytics. “2012 Quarterly State of the Market Report for PJM: January through March.” Section 10: “Congestion and Marginal Losses.” 2012; pp. 167-188. Accessed March 27, 2015: [http://www.monitoringanalytics.com/reports/PJM\\_State\\_of\\_the\\_Market/2012/2012q1-som-pjm-sec10.pdf](http://www.monitoringanalytics.com/reports/PJM_State_of_the_Market/2012/2012q1-som-pjm-sec10.pdf). Monitoring Analytics. “2014 State of the Market Report for PJM.” March 2015, p. 397. Accessed May 2015: [http://www.monitoringanalytics.com/reports/PJM\\_State\\_of\\_the\\_Market/2014/2014-som-pjm-volume2-sec11.pdf](http://www.monitoringanalytics.com/reports/PJM_State_of_the_Market/2014/2014-som-pjm-volume2-sec11.pdf).
- <sup>23</sup> U.S.-Canada Power System Outage Task Force. “Final Report on the August 14, 2003, Blackout in the United States and Canada: Causes and Recommendations.” April 2004. Accessed March 27, 2015: <http://energy.gov/sites/prod/files/oeprod/DocumentsandMedia/BlackoutFinal-Web.pdf>.
- <sup>24</sup> U.S. Department of Energy. “Office of Electricity Delivery and Energy Reliability, Synchronphasor Technologies & their Deployment in the Recovery Act Smart Grid Programs. August 2013, p. 2. Accessed March 27, 2015: [https://www.smartgrid.gov/sites/default/files/doc/files/Synchronphasor%20Report%2008%2009%202013%20DOE%20%282%29%20version\\_0.pdf](https://www.smartgrid.gov/sites/default/files/doc/files/Synchronphasor%20Report%2008%2009%202013%20DOE%20%282%29%20version_0.pdf).
- <sup>25</sup> Staffs of the Federal Energy Regulatory Commission and North American Electric Reliability Corporation. “Arizona-Southern California Outages on September 8, 2011: Causes and Recommendations.” April 2012, Staff Report. Available at: <http://www.ferc.gov/legal/staff-reports/04-27-2012-ferc-nerc-report.pdf>.
- <sup>26</sup> U.S. Department of Energy, Office of Electricity Delivery and Energy Reliability. “Synchronphasor Technologies & Their Deployment in the Recovery Act Smart Grid Programs.” August 2013. Accessed March 27, 2015: [https://www.smartgrid.gov/sites/default/files/doc/files/Synchronphasor%20Report%2008%2009%202013%20DOE%20%282%29%20version\\_0.pdf](https://www.smartgrid.gov/sites/default/files/doc/files/Synchronphasor%20Report%2008%2009%202013%20DOE%20%282%29%20version_0.pdf).
- <sup>27</sup> North American Electric Reliability Corporation. “Real-Time Application of Synchronphasors for Improving Reliability.” October 2010. Available at: <http://www.nerc.com/docs/oc/rapirtf/RAPIR%20final%20101710.pdf>.
- <sup>28</sup> California Independent System Operator. “Demand Response and Energy Efficiency Roadmap: Maximizing Preferred Resources.” December 2013. Available at: <http://www.caiso.com/Documents/DR-EERoadmap.pdf>.
- <sup>29</sup> Additional details associated with American Recovery and Reinvestment Smart Grid Investment Grants are available at [www.smartgrid.gov](http://www.smartgrid.gov).
- <sup>30</sup> U.S. Energy Information Administration. “Today in Energy: Natural Gas and Renewable Shares of Electricity Generation to Grow, Coal Still Largest.” February 10, 2012. <http://www.eia.gov/todayinenergy/detail.cfm?id=4950>.
- <sup>31</sup> North American Electric Reliability Corporation. “Potential Bulk System Reliability Impacts of Distributed Resources.” August 2011. Available at: [http://www.nerc.com/docs/pc/ivgtf/IVGTF\\_TF-1-8\\_Reliability-Impact-Distributed-Resources\\_Final-Draft\\_2011.pdf](http://www.nerc.com/docs/pc/ivgtf/IVGTF_TF-1-8_Reliability-Impact-Distributed-Resources_Final-Draft_2011.pdf).
- <sup>32</sup> Miller, C.; Martin, M.; Pinney, D.; Walker, G. “Achieving a Resilient and Agile Grid.” NRECA Cooperative Research Network, April 2014, version 1.0. Available at: [http://www.nreca.coop/wp-content/uploads/2014/05/Achieving\\_a\\_Resilient\\_and\\_Agile\\_Grid.pdf](http://www.nreca.coop/wp-content/uploads/2014/05/Achieving_a_Resilient_and_Agile_Grid.pdf).
- <sup>33</sup> The Edison Foundation Institute for Electric Innovation. “Utility-Scale Smart Meter Deployments, Plans, and Proposals.” May 2012. Available at: [http://www.edisonfoundation.net/iee/documents/iee\\_smartmeterrollouts\\_0512.pdf](http://www.edisonfoundation.net/iee/documents/iee_smartmeterrollouts_0512.pdf).
- <sup>34</sup> U.S. Department of Energy. “Demand Response Defers Investment in New Power Plants in Oklahoma.” April 2013. Available at: <https://www.smartgrid.gov/sites/default/files/doc/files/OGE%20CBS%20case%20study.pdf>.
- <sup>35</sup> U.S. Department of Energy. “Office of Electricity Delivery and Energy Reliability, Synchronphasor Technologies & Their Deployment in the Recovery Act Smart Grid Programs.” August 2013, p. 2. Accessed March 27, 2015: [https://www.smartgrid.gov/sites/default/files/doc/files/Synchronphasor%20Report%2008%2009%202013%20DOE%20%282%29%20version\\_0.pdf](https://www.smartgrid.gov/sites/default/files/doc/files/Synchronphasor%20Report%2008%2009%202013%20DOE%20%282%29%20version_0.pdf).
- <sup>36</sup> North American Synchronphasor Initiative (NASPI). “PMUs and Synchronphasor Data Flows in North America, as of March 19, 2014.” p. 5. Accessed March 27, 2015: [https://www.smartgrid.gov/sites/default/files/doc/files/naspi\\_pmu\\_data\\_flows\\_map\\_20140325.pdf](https://www.smartgrid.gov/sites/default/files/doc/files/naspi_pmu_data_flows_map_20140325.pdf).
- <sup>37</sup> For detailed RE applications for synchronphasors, see U.S. Department of Energy, Office of Electricity Delivery and Energy Reliability, and North American Synchronphasor Initiative (NASPI), “NASPI Technical Report—Synchronphasor Technology and Renewables Integration.” June 7, 2012. Accessed March 27, 2015: [https://www.smartgrid.gov/sites/default/files/doc/files/NASPI-NREL\\_renewables\\_integration\\_with\\_synchronphasors.pdf](https://www.smartgrid.gov/sites/default/files/doc/files/NASPI-NREL_renewables_integration_with_synchronphasors.pdf).

- <sup>38</sup> U.S. Department of Energy. “Synchrophasor Technologies & Their Deployment in the Recovery Act Smart Grid Programs.” August 2013, p. 6. Available at: [https://www.smartgrid.gov/document/synchrophasor\\_technologies\\_and\\_their\\_deployment\\_recovery\\_act\\_smart\\_grid\\_programs](https://www.smartgrid.gov/document/synchrophasor_technologies_and_their_deployment_recovery_act_smart_grid_programs).
- <sup>39</sup> Southern California Edison. “Technology Performance Report #1—Irvine Smart Grid Demonstration: A Regional Smart Grid Demonstration Project.” Available at: [https://www.smartgrid.gov/sites/default/files/doc/files/SCE-ISGD-TPR-1\\_Final.pdf](https://www.smartgrid.gov/sites/default/files/doc/files/SCE-ISGD-TPR-1_Final.pdf).
- <sup>40</sup> U.S. Department of Energy, Office of Electricity Delivery and Energy Reliability. “Smart Grid Investment Grant Program: Application of Automated Controls for Voltage and Reactive Power Management—Initial Results.” December 2012. Accessed March 27, 2015: <https://www.smartgrid.gov/sites/default/files/doc/files/VVO%20Report%20-%20Final.pdf>.
- <sup>41</sup> GridWise Architecture Council. “GridWise Transactive Energy Framework Version 1.1.” January 2015. Accessed March 27, 2015: [http://www.gridwiseac.org/pdfs/te\\_framework\\_report\\_pnnl-22946.pdf](http://www.gridwiseac.org/pdfs/te_framework_report_pnnl-22946.pdf).
- <sup>42</sup> Ibid.
- <sup>43</sup> Southern California Edison. “Technology Performance Report #1—Irvine Smart Grid Demonstration: A Regional Smart Grid Demonstration Project.” p. 70. Available at: [https://www.smartgrid.gov/sites/default/files/doc/files/SCE-ISGD-TPR-1\\_Final.pdf](https://www.smartgrid.gov/sites/default/files/doc/files/SCE-ISGD-TPR-1_Final.pdf).
- <sup>44</sup> ABB. “Power Transformers: Built for Reliability and Efficiency.” 2011. Available at: [http://www05.abb.com/global/scot/scot252.nsf/veritydisplay/a2492a9e17a69c1a83257984002ada63/\\$file/Global\\_low%20res.pdf](http://www05.abb.com/global/scot/scot252.nsf/veritydisplay/a2492a9e17a69c1a83257984002ada63/$file/Global_low%20res.pdf).
- <sup>45</sup> U.S. Department of Energy, Office of Electricity Delivery and Energy Reliability. “Large Power Transformers and the U.S. Electric Grid. April 2014, Update. Accessed March 27, 2015: <http://energy.gov/sites/prod/files/2014/04/f15/LPTStudyUpdate-040914.pdf>.
- <sup>46</sup> Rathod, D. K. “Solid State Transformer (SST) Review of Recent Developments.” *Advance in Electronic and Electric Engineering*, ISSN 2231-1297, (4:1), 2014; pp. 45-50. Accessed March 27, 2015: [http://www.ripublication.com/aeer\\_spl/aeer4n1spl\\_07.pdf](http://www.ripublication.com/aeer_spl/aeer4n1spl_07.pdf).
- <sup>47</sup> MarketsandMarkets, “Solid State (Smart) Transformer Market is expected to reach \$5,043.39 million at CAGR of 82.3% by 2020.” PRWeb, February 23, 2013. Accessed March 27, 2015: <http://www.prweb.com/releases/solid-state-smart/transformer-market/prweb10458931.htm>.
- <sup>48</sup> Fairley, P. “Flexible AC Transmission: The FACTS Machine.” *IEEE Spectrum*, December 30, 2010. Accessed March 27, 2015: <http://spectrum.ieee.org/energy/the-smarter-grid/flexible-ac-transmission-the-facts-machine>.
- <sup>49</sup> Electric Power Research Institute (EPRI). “Superconducting Fault Current Limiters: Technology Watch 2009.” EPRI, Palo Alto, CA, 2009. 1017793. Accessed March 27, 2015: <http://www.smartgridnews.com/artman/uploads/1/000000000001017793.pdf>.
- <sup>50</sup> U.S. Energy Information Administration. “Frequently Asked Questions: How Much Electricity Is Lost in Transmission and Distribution in the United States?” Last Updated: May 7, 2014. Accessed March 27, 2015: <http://www.eia.gov/tools/faqs/faq.cfm?id=105&t=3>.
- <sup>51</sup> Hjortstam, O.; et al. “Can We Achieve Ultra-Low Resistivity in Carbon Nanotube-Based Metal Composites?” *Appl. Phys. A* (78), 2004; p. 1175.
- <sup>52</sup> American Superconductor (AMSC). “Superconductor Cable Systems.” 2013. Accessed March 27, 2015: [http://www.amsc.com/gridtec/superconductor\\_cable\\_systems.html](http://www.amsc.com/gridtec/superconductor_cable_systems.html).
- <sup>53</sup> Ruth, M. F.; Kroposki, B. “Energy Systems Integration: An Evolving Energy Paradigm.” *The Electricity Journal* (27:6), July 2014; pp. 36–47. Accessed March 27, 2015: <http://www.sciencedirect.com/science/article/pii/S1040619014001195#vt0010>.
- <sup>54</sup> Argonne National Laboratory. “Smart Grid EV Communication Module.” Accessed March 27, 2015: <http://www.anl.gov/technology/project/smart-grid-ev-communication-module>.
- <sup>55</sup> Basu, C.; Ghatikar, G.; Bansal, P. “Enabling Efficient, Responsive, and Resilient Buildings: A Collaboration Between the United States and India.” Presented and published at the IEEE Proceedings on Smart Grid and the New Energy Economy, Chicago, IL, September 2013. LBNL-6594E.
- <sup>56</sup> DOE Microgrid Exchange Group. “Microgrid Definition.” October 2010.
- <sup>57</sup> Sandia National Laboratories. “DOE/EPRI, 2013 Electricity Storage Handbook in Collaboration with NRECA.” SAND2013-5131, Albuquerque, NM, and Livermore, CA: July 2013. Accessed March 27, 2015: <http://energy.gov/sites/prod/files/2013/08/f2/ElecStorageHndbk2013.pdf>.
- <sup>58</sup> Sandia National Laboratories. “DOE/EPRI, 2013 Electricity Storage Handbook in Collaboration with NRECA.” SAND2013-5131, Albuquerque, NM, and Livermore, CA: July 2013. Accessed March 27, 2015: <http://energy.gov/sites/prod/files/2013/08/f2/ElecStorageHndbk2013.pdf>.
- <sup>59</sup> Yang, C.-J.; Jackson, R. B. “Opportunities and Barriers to Pumped-hydro Energy Storage in the United States.” *Renewable and Sustainable Energy Reviews* (15: 1), 2011; pp. 839-844.
- <sup>60</sup> Sandia National Laboratories. “DOE/EPRI, 2013 Electricity Storage Handbook in Collaboration with NRECA.” SAND2013-5131, Albuquerque, NM, and Livermore, CA, July 2013. Accessed March 27, 2015: <http://energy.gov/sites/prod/files/2013/08/f2/ElecStorageHndbk2013.pdf>.
- <sup>61</sup> Leonard, K.C. “Ultracapacitors for Off-Grid Solar Energy Applications.” SolRayo, LLC. Available at: [http://www.solrayo.com/SolRayo/Off-Grid\\_Solar\\_Energy\\_Applications\\_files/Ultracapacitors%20for%20Off-Grid%20Solar%20Applications.pdf](http://www.solrayo.com/SolRayo/Off-Grid_Solar_Energy_Applications_files/Ultracapacitors%20for%20Off-Grid%20Solar%20Applications.pdf).
- <sup>62</sup> Steward, D.; Saur, G.; Penev, M.; Ramsden, T. “Lifecycle Cost Analysis of Hydrogen versus Other Technologies for Electrical Energy Storage.” National Renewable Energy Lab, Technical Report NREL/TP-560-46719, November 2009.
- <sup>63</sup> von Meier, A. “The Supple Grid: Challenges and Opportunities for Integrating Renewable Generation.” Presented at the UC Center Sacramento, May 9, 2013. Accessed March 27, 2015: [http://ucss.ucdavis.edu/VonMeier\\_SuppleGrid\\_5\\_9\\_13.pdf](http://ucss.ucdavis.edu/VonMeier_SuppleGrid_5_9_13.pdf).
- <sup>64</sup> Kalsi, K.; Fuller, J. C.; Tuffner, F. K.; Lian, J.; Zhang, W.; Marinovici, L. D.; Fisher, A. R.; Chassin, F. C.; Hauer, M. L. “Integrated Transmission and Distribution Control.” No. PNNL-22157. Pacific Northwest National Laboratory (PNNL), Richland, WA (US), 2013.

- <sup>65</sup> Eaton. “Power Outage Annual Report: Blackout Tracker: United States Annual Report 2014.” Available at: [www.eaton.com/blackouttracker](http://www.eaton.com/blackouttracker).
- <sup>66</sup> U.S. Government Accountability Office. “Transmission Lines: Issues Associated with High-Voltage Direct-Current Transmission Lines Along Transportation Rights of Way.” GAO-08-347R. Published February 1, 2008. Publicly Released February 1, 2008. Accessed March 27, 2015: <http://www.gao.gov/products/GAO-08-347R>.
- <sup>67</sup> Energy Sector Control Systems Working Group. “Roadmap to Achieve Energy Delivery Systems Cybersecurity.” September 2011. Accessed March 27, 2015: [http://energy.gov/sites/prod/files/Energy%20Delivery%20Systems%20Cybersecurity%20Roadmap\\_finalweb.pdf](http://energy.gov/sites/prod/files/Energy%20Delivery%20Systems%20Cybersecurity%20Roadmap_finalweb.pdf).
- <sup>68</sup> Energy Sector Control Working Group. “Interactive Energy Roadmap to Achieve Energy Delivery Systems Cybersecurity.” 2015. Accessed March 27, 2015: <https://www.controlsroadmap.net/Pages/default.aspx>.
- <sup>69</sup> North American Electric Reliability Corporation and the U.S. Department of Energy. “High-Impact, Low-Frequency Event Risk to the North American Bulk Power System.” June 2010. Accessed March 27, 2015: <http://energy.gov/sites/prod/files/High-Impact%20Low-Frequency%20Event%20Risk%20to%20the%20North%20American%20Bulk%20Power%20System%20-%202010.pdf>.
- <sup>70</sup> North American Electricity Reliability Corporation. “Severe Impact Resilience Task Force, Severe Impact Resilience: Considerations and Recommendations.” May 9, 2012. Accessed March 27, 2015: [http://www.nerc.com/docs/oc/sirtf/SIRTF\\_Final\\_May\\_9\\_2012-Board\\_Accepted.pdf](http://www.nerc.com/docs/oc/sirtf/SIRTF_Final_May_9_2012-Board_Accepted.pdf).
- <sup>71</sup> Dvorak, P. “How Standardized Power Transformers Step up More than Voltage for Wind Farms.” Wind Power Engineering & Development, June 26, 2014. Accessed March 27, 2015: <http://www.windpowerengineering.com/construction/transportation/standardized-power-transformers-step-voltage-wind-farms/>.
- <sup>72</sup> U.S. Department of Energy. “Benefits of Using Mobile Transformers and Mobile Substations for Rapidly Restoring Electrical Service.” August 2006.





## Issues and RDD&D Opportunities

- Electric power generation technologies are maturing to a new level of integration and interdependence that requires an expanded system approach and a global view to optimize integration, minimize risks, and maintain reasonable costs.
- There is potential in each of the technologies: more efficient coal and natural gas generation with carbon capture; advanced nuclear reactors; rapidly advancing renewable technologies, such as wind and solar; and developing technologies, such as fuel cell and marine hydrokinetic power.
- Common component developments offer opportunities for breakthroughs: advances in high temperature and pressure steam turbines, new supercritical carbon dioxide power cycles, hybrid systems matching renewables with nuclear or fossil, and energy storage.
- Advanced capabilities in materials, computing, and manufacturing can significantly improve electric power technologies cost and performance.
- A systems approach for the power sector (as described in Chapter 3) also enables innovation at the technology level, such as by identifying key characteristics needed in supply technologies to meet the changing requirements of the grid, including such factors as cost, efficiency, emissions, ramping rates, turn-down ratios, water use, and others. These can be approached through multivariable portfolio analysis.
- International cooperation greatly expands the collective research, development, demonstration, and deployment (RDD&D) investment in clean power technologies by governments and industry, accelerating the successful completion of demonstrations and full commercial deployment.



# 4

## Advancing Clean Electric Power Technologies

### 4.1 Introduction

Clean electric power is paramount to today's mission to meet our interdependent security, economic, and environmental goals. While supporting aggressive emission reductions, the traditional market drivers such as reliability, safety, and affordability must be maintained and enhanced. The current portfolio of electric production includes a combination of reliable, but aging, baseload generation, evolving renewable resources, and new natural gas resources. Complementing this evolving generation mix are technologies to enable higher efficiencies and pollution control.

This chapter describes the current status and future outlook for power generation technologies and identifies a portfolio of RDD&D directions and opportunities that can be available to meet future regional demands. A combination of flexible technology options will be required to meet increasing power needs and the security, economic, and environmental challenges outlined in Chapter 1. The International Energy Agency (IEA) projects that world primary energy demand could grow by 37% between 2012 and 2040, assuming existing and planned government policies,<sup>1</sup> and during this period electricity demand is projected to grow by 78%. This review will not make regulatory and market policy recommendations as these are addressed by the Quadrennial Energy Review (QER).

Through 2050, most of the increased energy demand and carbon dioxide (CO<sub>2</sub>) emissions are projected to be in non-Organisation for Economic Co-operation and Development (OECD) countries.<sup>2</sup> There will be interactions between energy technologies, international policies, and global market competitiveness. The Quadrennial Technology Review (QTR) focuses on technological advances to meet U.S. energy needs and challenges, recognizing that these also offer opportunities for cooperative research that will expedite the international deployment of these technologies. For example, there is significant ongoing cooperative research with China in pre-competitive areas on technologies such as carbon capture and storage (CCS), and there is progress toward cooperation in large-scale demonstrations that are expected to be complex and expensive, with long lead times.

#### 4.1.1 Progress since the Last Review

The development of a robust portfolio of clean power technologies has seen major progress. Investments made through the American Recovery and Reinvestment Act (ARRA) are demonstrating returns in record levels of efficiency, flexibility, and lowered emissions. The ability to take on costly demonstration projects to advance technology, decrease developmental risks, and provide baselines for future deployment has been critical in making headway toward advanced technologies that require significant investment for demonstration, such as CCS and small nuclear reactors. Four years ago, only a single large-scale CCS demonstration project had begun construction in the United States. As of August 2015, one project is operational and three more are under construction. Globally, the number of large-scale CCS demonstration projects has doubled in this time frame, many with U.S. involvement, providing a wealth of data on CO<sub>2</sub> capture systems and CO<sub>2</sub> storage.

Since 2011, two passively-safe reactor designs have received certification from the U.S. Nuclear Regulatory Commission (NRC) under a new regulatory framework that requires a single approval for construction and operation. Three utilities received combined construction and operating licenses that are enabling the construction of the first four new reactors in more than thirty years in the United States. Additionally, renewable energy technologies have seen dramatic cost reductions, which have supported rapidly gaining market share as shown in Table 4.1. This increase in scale is bringing down costs further and leading to next-generation advancements which will result in even greater deployment.

**Table 4.1** Electric Power Capacity and Production, 2010 and 2014

	Generation capacity 2010 (GW)	Generation capacity 2014 (GW)	Power production 2010 (TWh)	Power production 2014 (TWh)
Coal	316.8	300.4	1,847	1,586
Gas	409.7	430.3	999	1,122
Nuclear	101.2	99.2	807	795
Hydropower	78.8	79.2	260	258
Wind	39.1	66	95	182
Biopower	11.4	13.4	53	64
Solar	0.86	9.3	1.2	18.3
Geothermal	2.4	2.6	15	17
Fuel cell	0.06	0.2	0.3	1
Marine and hydrokinetic	0	0	0	0

Data from U.S. Energy Information Administration (EIA) *Electric Power Monthly* Feb 2015 Tables 1.1, 1.1a, and 6.1; 2010 Capacity from EIA *Electric Power Annual* Report 2013 tables 4.2a and 4.2b. Fuel cell data through June 2014 from Breakthrough Technologies Institute. EIA solar reporting does not represent about 8.5 gigawatts (GW) of distributed systems reported by SEIA in December 2014.

### 4.1.2 Balancing Drivers

To produce electricity, power companies assemble a portfolio of generation technologies that are selected in the context of myriad considerations, which are changing over time. The central requirement is that the power system must provide reliable power; to do this it must have the flexibility to respond to changes in demand and the resiliency to restore service following perturbations. Additionally, the power system must operate safely while protecting the environment and at a reasonable cost to the consumer.

Investment in the deployment of power technology is made on the local scale by power companies with state and federal review. In the past, selection of technologies was traditionally based on balancing regional customer demand, transmission availability, and resources of fuel and water. These siting characteristics would be evaluated based upon a specific location and the technology being considered. In recent decades, the need to address traditional criteria air pollutants, and more recently mercury and air toxics, was factored into the decision making around technology deployments. The evolving criteria for selecting power technologies is depicted in Figure 4.1.

**Figure 4.1** Requirements and criteria have expanded over time.

Siting Characteristics				Environmental Criteria				Electric System		
<i>Traditional Pollutants</i>	<i>Local Resources</i>	<i>Transmission Connection</i>	<i>Water Availability</i>	<i>GHG Footprint</i>	<i>Minimal Land Use</i>	<i>Water Impacts</i>	<i>Manage Waste</i>	<i>Load Following</i>	<i>Dispatch-ability</i>	<i>Security</i>

As the electricity system evolves to address increased security, economic, and environmental challenges, the drivers that shape technology deployment decisions have expanded. The electricity system as a whole must be able to respond to variations in the level of output produced, maintain the ability to reliably generate power when needed, and do so while maintaining security against physical and cyber threats. Economic requirements motivate increased reliability and lowered costs. Environmental requirements include land impacts, water consumption and quality, waste management, and greenhouse gas (GHG) emissions. Finding a realistic balance between competing drivers (security, cost, environment, and societal energy demand versus acceptance) motivates new technology solutions that can match regional resources and local requirements.

Advancing clean electric power generation requires developing a full set of options, being cognizant of complementing strengths and weaknesses, and finding optimal system combinations to meet basic requirements and future criteria. Progress consists of advancements in technologies currently deployed, such as coal or nuclear; rapidly advancing renewable technologies, such as wind and solar; and technologies entering deployment, such as CCS, fuel cells, and, on the horizon, enhanced geothermal. The following sections review the strengths, challenges, and emerging opportunities for each electric power generation technology.

### 4.1.3 Technology Options in a Clean Electric Power Portfolio

For the electricity sector to meet all of its varied requirements, the characteristics of the individual technologies that comprise the generation system must be considered. Nuclear energy, for example, is capable of providing non-GHG emitting power, but is not well-suited to vary its output in response to the needs of the grid, and it generates nuclear waste that requires careful management. The development of coal with CCS addresses concerns about GHG emissions, but in doing so, significantly increases the water required for plant operations unless dry cooling is used. Wind power does not directly emit GHGs and requires little water, but the areas that have the most favorable resources may have limitations in their ability to access established transmission lines, and variation of power output also presents challenges. All of the technologies addressed in this chapter have differing attributes across these and other criteria.

While some shortcomings are inherent in the technologies themselves, RDD&D in these technologies can help to improve their performance characteristics. Nuclear fission will always produce radioactive wastes, but the development of new reactor technologies may make them more manageable. Feedstocks for biopower will need large areas for production, but RDD&D may lead to approaches that require less of it or use marginal lands. The discussion of the technologies in this chapter along with the accompanying technology assessments will provide a more complete picture of the RDD&D opportunities available.

The societal need for the electricity system to be cleaner and more robust and the market failure that arises from these externalities not being internalized by industry creates a role for government support through RDD&D. This builds upon long-established recognition that the public sector has an important role to play in advancing electricity technologies owing to the centrality of electricity to the national economy and the long timelines necessary to realize the benefits from investments in RDD&D. The government role in RDD&D for electricity technologies varies based upon the level of maturity and involves collaboration with the national labs and universities, and direct engagement with industry to identify and overcome the challenges facing technology development.

### 4.1.4 Portfolio Management

Even with RDD&D to improve the performance of electricity generation technologies, each technology still possesses strengths and weaknesses relative to the other. These varying attributes can be used to complement one another as they will be deployed as part of a portfolio of technologies that will comprise an electricity generation system. In this context, the shortcomings of one technology can be offset by the strengths of another in the system. Nuclear and coal as currently deployed are generally best-suited to run in full-time baseload operation rather than vary their output in response to changing wind or solar production, while the inclusion of natural gas or hydro in the portfolio leaves the system better suited to accommodate these changes. Ensuring stable and secure operation of the grid sets functional requirements of the entire system. A major change in the system could be achieved by different modes of operation including microgrids, hybrid systems, and energy storage. Utility-scale energy storage would address many of the shortcomings of variable power sources, as well as increase security and resiliency of the power system.<sup>3</sup>

The private sector generally makes the decisions about which technologies to deploy in the electricity generating portfolio. These companies must respond to the needs of the market, including customers' and shareholders', while operating within regulations established to govern the power sector. Depending upon these factors and the access to and availability of energy resources, the composition of regional energy portfolios, both domestically and globally, varies widely. In the United States, the federal government does not make deployment choices, but it can help shape them through regulation and policy. Environmental and reliability regulations can require companies to emphasize or value certain attributes of a technology, and subsidies or credits established in policy are intended to incentivize deployment of certain technologies. State governments often play a role in guiding deployment decisions, especially those that have regulated electricity markets, which require companies to receive state approval of plans to manage the electricity system.

### 4.1.5 Portfolio Approach

Electric power generation technologies are maturing to a new level of integration and interdependencies that require a system approach and a global view. As the industry evolves to meet growing electrification and GHG-reduction goals, challenges arise in optimizing the system, minimizing risks, and maintaining reasonable cost. Domestic choices on clean energy technologies also interface with global energy choices. Technologies are

**Figure 4.2** SaskPower Boundary Dam CCS Project: Pushing CCS Forward Internationally

Credit: SaskPower



needed that will provide a portfolio of options for reliable, affordable, and clean power generation; available to meet regional needs; provide future flexibility; and enable a U.S. leadership role in global energy and environmental dialogue and markets. This chapter will identify key technical challenges and opportunities in RDD&D that can come to fruition by 2030 and be commercialized with significant impacts by 2050.

## 4.2 Clean Power Technologies

The 2011 QTR stated that “Recent power generation deployment trends show that economics, technology, incentives, and regulation are already driving the nation to new and more diverse generating technologies, and there is every indication that, even absent new energy or emissions policies, the next decades’ deployed generation will be very different from the incumbents’. RDD&D will be most productive if it is conducted in a manner cognizant of these trends.” This still remains the case, although the advent of abundant and affordable domestic natural gas supplies is having a significant near-term impact on new generation deployments.

### 4.2.1 Fossil Power with Carbon Capture and Storage

Fossil fuels currently supply 80% of the world’s electric power. Globally, the demand for coal is projected to continue growth, but slowing to a rate of just 0.5% per year to reach 6,350 metric tonnes carbon equivalent in 2040, while natural gas has seen a near 50% rise in global production with recent advances in unconventional sources following a near-linear growth to 5,400 billion cubic meters in 2040.<sup>4</sup> Domestic projections for energy use are provided by the Energy Information Administration.<sup>5</sup> Domestically, coal and natural gas plants provide power generation and drive numerous industrial processes. However, it is critical to minimize CO<sub>2</sub> emissions from fossil power generation, while maintaining cost-effective power generation.

CCS technology is used to separate, capture, transport, and permanently store CO<sub>2</sub> emissions from power plants and industrial facilities. The IEA projects that CCS will be required for 14% of the global cumulative CO<sub>2</sub> emissions reductions by 2050, for a scenario with less than a 2°C rise in global temperatures.<sup>6</sup> In fact, without a CCS mitigation option, the United Nations Framework Convention on Climate Change projects that the costs of achieving this global goal would increase by 138%.<sup>7</sup>

The primary challenges to full implementation are experience and commitment to commercial-scale demonstration, establishing the basis for financial support through confidence in the technology and lowering costs, and implementing effective policy drivers to increase deployments. First-generation, large-scale CCS demonstrations are being demonstrated around the world. One example is the SaskPower Boundary Dam Project, shown in Figure 4.2. Another is the Southern Company Kemper Project shown in Figure 4.3. Such demonstrations establish that CCS can be integrated at commercial scale while maintaining reliable, predictable, and safe plant operations. As a positive

**Figure 4.3** Southern Company Kemper Project

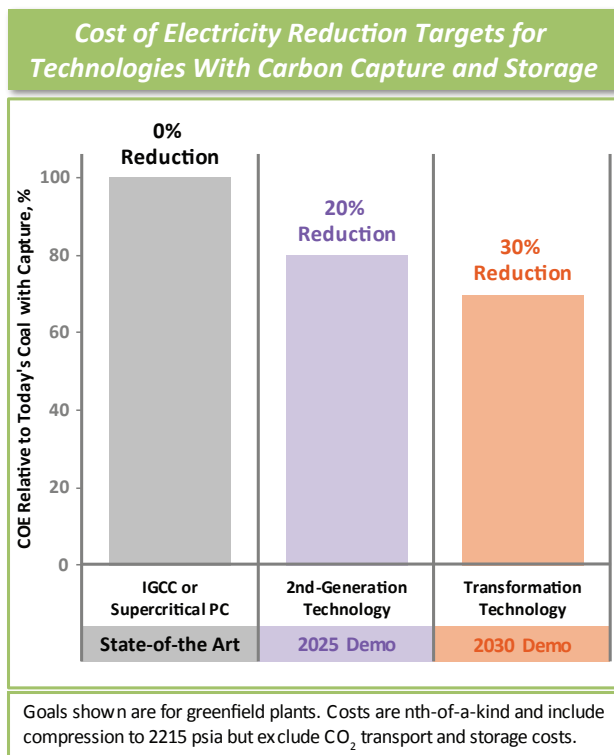
Credit: Mississippi Power



Southern Company Services, Inc. of Birmingham, Alabama, is developing an air-blown IGCC power plant large-scale demonstration project utilizing a coal-based transport gasifier. The project will deploy the Selexol physical solvent technology to demonstrate about 67% CO<sub>2</sub> removal, roughly three million tons per year. A sixty-mile CO<sub>2</sub> pipeline has been built to connect to an existing CO<sub>2</sub> pipeline used for enhanced oil recovery.

movement toward the next step, the SaskPower Boundary Dam project is the world's first large-scale, coal-fired, post-combustion carbon capture plant. The capture unit, based on Shell's Cansolv process, is a retrofit of Unit 3 at the Boundary Dam plant, and captures 90% of its CO<sub>2</sub> emissions, more than 1.1 million metric tonnes of CO<sub>2</sub> per year. The CO<sub>2</sub> is transported and used in the Weyburn oil fields for enhanced oil recovery. As shown in Figure 4.4, building upon these successes, technologies for coal power with CCS are pursuing aggressive leveled cost of electricity (LCOE) reduction targets.

**Figure 4.4** Potential for Bringing Down Nth-of-a-Kind Cost Compared to First-Generation CCS Technology (as evaluated to define DOE CCS program targets)



Second-generation CCS technology includes a suite of improvements in capture performance, plant efficiencies, and component cost, and expanded characterization of storage options. These technologies are expected to become commercially available in the mid-2020s. Analyses of coal power with CCS conducted by the National Energy Technology Laboratory (NETL) show a 20% decrease in costs of mature units compared to first-generation CCS technology.<sup>8</sup>

Modeled deployment of transformational technology shows potential for a 30% reduction in LCOE. RDD&D of transformational technologies will make significant use of emerging capabilities such as integration of advanced manufacturing methods into supply chains for a variety

of new technologies under development (e.g., high temperature alloys, high performance ceramics, and integration of ceramic to metal elements) to reduce cost and improve processing time. Advanced simulation will increasingly be employed to rigorously screen and evaluate new technologies and accelerate scale-up processes.

### Large-Scale Integrated Demonstration and Deployment

Large-scale integrated technology demonstrations enable deployment of advanced CCS technologies by reducing technology risk at-scale. There are currently twenty-two large-scale CCS projects globally in the “operate” or “execute” stages (i.e., between detailed design and commissioning), and thirty-three projects in earlier stages.<sup>9</sup> Data on CO<sub>2</sub> capture systems and CO<sub>2</sub> storage are accumulating through these global CCS projects, which span power generation and industrial platforms representing various technology configurations, utilizing a diverse set of feedstocks, producing a variety of commodities, and accessing a range of permanent storage solutions.

U.S. private-public partnerships include the largest portfolio of large-scale integrated CCS demonstration projects in the world. Southern Company's Plant Barry has demonstrated the integrated performance of capture and storage on a portion of a coal plant's exhaust stream.<sup>10</sup> A 240 megawatt (MW) post-combustion project

designed to capture 90% of its CO<sub>2</sub> flue gas emissions is under construction at NRG Energy's WA Parish facility. Southern Company's 582 MW Kemper Project (see Figure 4.4) plans to integrate CCS with advanced Integrated Gasification Combined Cycle (IGCC) units. Industrial sector projects include Air Products (CO<sub>2</sub> capture from steam methane reformers), Archer Daniels Midland (CO<sub>2</sub> capture from ethanol production), and Skyonics (mineralize CO<sub>2</sub> for saleable products).

## CO<sub>2</sub> Capture Technology

Two approaches to carbon capture are post-combustion and pre-combustion capture. Post-combustion capture is applicable to the pulverized coal (PC) combustion and natural gas systems used in typical fossil fueled power plants today, while pre-combustion capture can be designed with an IGCC for a highly efficient, flexible-operation, advanced power generation system. Both separation techniques use solvents, sorbents, or membranes to separate CO<sub>2</sub>. Key challenges for solvents and sorbents are reducing the energy required for releasing the CO<sub>2</sub> to regenerate the solvent or sorbent, increasing reaction speed, and reducing material cost. Improving durability and tolerance to contaminants, and CO<sub>2</sub> selectivity are critical for membranes. Advancements in manufacturing and process chemistry, integration with the power plant, and engineering and design all offer opportunities. In addition, novel research currently explores technologies such as electrochemical-based approaches, direct CO<sub>2</sub> phase change using passive nozzle designs, supersonic gas separation, and electrochemical capture. Such advanced concepts are focused on developing transformational systems that have the potential to realize step-change improvements in cost and performance beyond those seen using the more conventional solvents, sorbents, and membranes. First-generation systems, such as the Boundary Dam project, are operating now.

Small pilot-scale tests (e.g., one megawatt electrical [MWe]) of second-generation capture technologies, such as advanced solvents, sorbents, and membranes, are currently being conducted. Promising technologies, successful at the smaller scale, could be tested at large pilot-scale (10+ MWe) to advance the technology for possible first-of-a-kind demonstration by 2020. Additionally, transformational technologies, which have the potential for further cost reductions, are being tested at laboratory- and bench-scale and could be ready for commercial demonstration by as early as 2025.

## High Efficiency, Low Cost Energy Systems, and Integrated Capture Concepts

Efforts to improve base plant costs and efficiencies are integral to CCS, and in some cases (e.g., gasification-based technologies) can have a greater impact on LCOE reduction for a fossil plant with CCS than improved capture technology. The non-capture components of a power plant offer opportunities for improving fuel conversion efficiencies, increasing plant availability, reducing water consumption, and achieving ultra-low emissions of traditional pollutants. For gasification and natural gas technologies, this includes low-cost air separation membranes, high efficiency hydrogen turbines, more efficient gas cleanup, and high temperature fuel cells. For pulverized coal plants, it includes advanced turbines, supercritical CO<sub>2</sub> (sCO<sub>2</sub>) power cycles, and high-temperature durable materials.

Alternative combustion processes are being explored. Oxy-combustion, which burns coal directly with oxygen creating highly concentrated CO<sub>2</sub>, and chemical looping, in which oxygen is separated from air as an inherent part of the combustion process, are examples. Reducing the water footprint is of critical importance through the deployment of highly efficient power generation systems, development of novel systems that require very little water, and water treatment and reuse within the power generation industry. In addition, fossil energy plants may serve as sources or supplies for fresh water through application of novel and emerging technologies.

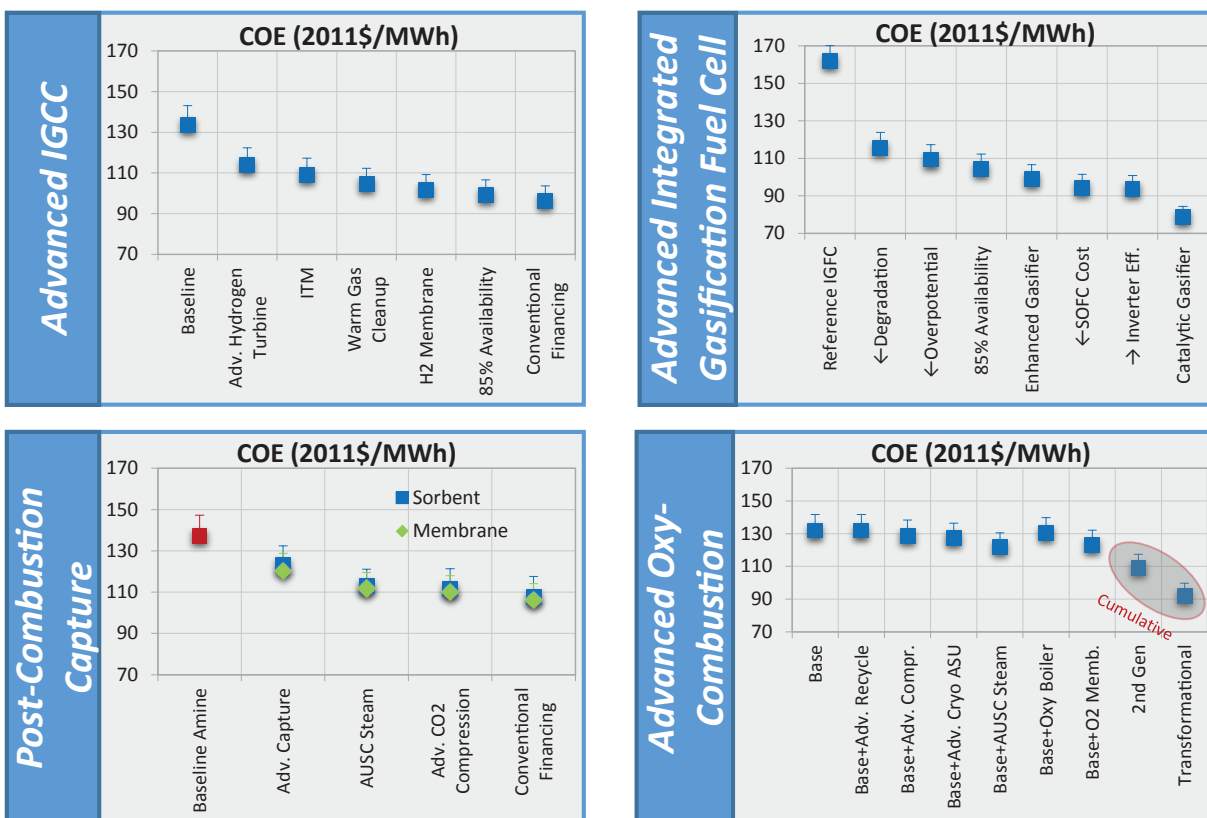
Examples of advanced systems include turbine-based cycles that operate at temperatures up to 3100°F with the potential to achieve 65% combined cycle efficiencies, but require advanced materials, system modeling,

transition strategies and low nitrogen oxides ( $\text{NO}_x$ ) combustion. Supercritical  $\text{CO}_2$  power cycles have the potential to reduce the cost of coal-based power generation by 5%–15%. The goal is to pilot test a pre-commercial scale 50 MW  $\text{sCO}_2$  power cycle unit, demonstrate reliable operation, and integrate with CCS and other transformational technologies to reduce the cost of CCS by 30% by 2025.

Analysis of the cumulative effects as multiple advanced components are integrated into a plant are used to evaluate the potential impacts, demonstrating that the pursuit of multiple combustion and gasification pathways is key to significantly improving the efficiency and decreasing the cost of electricity (COE) of fossil plants with CCS.<sup>11</sup> Figure 4.5 shows several such integrated evaluations of COE improvements, achieved along a variety of technology development pathways being pursued in CCS RDD&D. In this analysis advanced technologies have each been assessed individually and cumulatively in the appropriate combustion and gasification pathways to assess the impact to key metrics such as net plant efficiency and COE. Technologies evaluated are at varying technology readiness levels; thus, both the cost and performance data available to perform the evaluation and the anticipated date for commercial readiness vary significantly, and require RDD&D across multiple advanced technologies to be successful. Key conclusions include the following:

- Technologies providing improvement in power cycle efficiency (absorption heat transformer, solid oxide fuel cells, advanced ultra supercritical steam conditions) are key to each pathway through reducing operating and fixed costs per unit of net power generated.
- Reduction of auxiliary loads and cost improvements of supporting systems, such as oxygen production and gas cleanup, are critical to advanced oxy-combustion and IGCC.

**Figure 4.5** Cost Projections for Advanced Fossil-CCS Plants. Integrated technology improvements and parallel pathways are required to drive down the cost of CCS on fossil plants and reflects nth-of-a-kind cost and performance. (Source: Gerdes et al. Energy Procedia 63 [2014] 7541–7557)



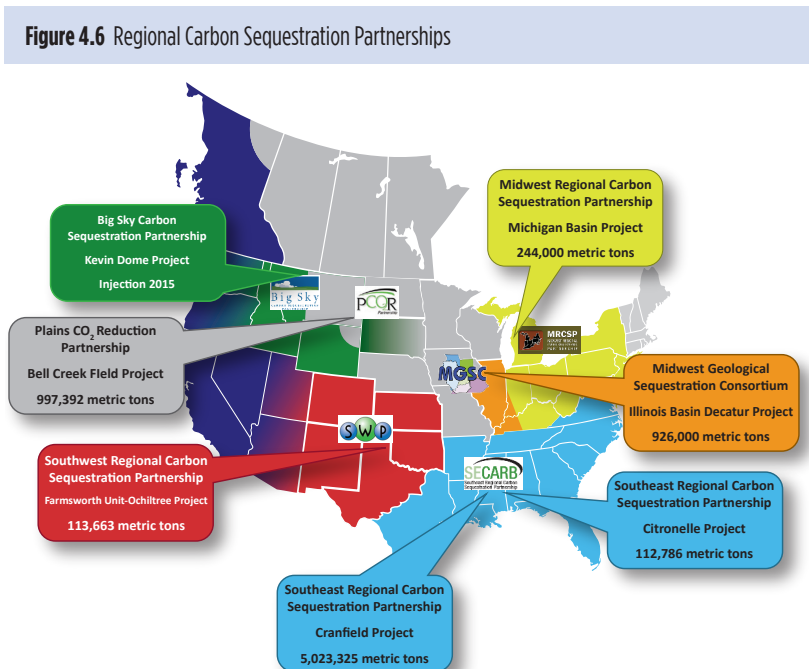


- Improvements in the energy penalty and cost associated with CO<sub>2</sub> capture technology play a significant role in the post-combustion capture pathway and are applicable to both greenfield and retrofit applications.

## CO<sub>2</sub> Storage Technology

Development of a successful CO<sub>2</sub> storage industry will require storage that is safe and permanent. Both globally and in the United States, deep saline formations offer the greatest potential for the CO<sub>2</sub> storage necessary to provide meaningful reductions in carbon emissions. As the state-of-the-art technology for CO<sub>2</sub> storage has advanced, a growing number of CO<sub>2</sub> injection projects have been established around the world. In North America alone, more than 10 million metric tonnes of CO<sub>2</sub> have been successfully stored in large-scale field projects. While great progress has been made in saline formation storage over the past decade, work remains to be done.

CO<sub>2</sub> storage RDD&D leverages decades of experience from a range of industries such as oil and gas, industrial process fluid injection, and municipal fluid disposal and storage, which provide a basis of geologic characterization, modeling, and monitoring tools. Durable, robust, and cost-effective technologies are needed for geologic storage of CO<sub>2</sub>, and field tests are necessary to validate technologies and address critical challenges such as long-term wellbore integrity, geomechanics (i.e., stress state), adaptive control of fluid flow and pressure management, and higher resolution characterization and mapping of the subsurface to identify fractures and faults that are natural or are a result of other subsurface activity. In addition, improved tools are needed to monitor and verify permanent storage of CO<sub>2</sub>, mitigate potential risks, and increase storage efficiency. CCS subsurface challenges are closely aligned with those faced by other sectors that utilize the subsurface for energy production and storage or disposal of energy waste streams (see also the Supplemental Information for Chapter 7 on *Subsurface Science and Technology*). Activities such as the Regional Carbon Sequestration Partnerships (RCSP) conduct large-scale field projects in different storage types in various formation classes, distributed over different geographic regions, to provide a sound basis for commercial-scale CO<sub>2</sub> storage projects. The RCSP has seven partnerships encompassing forty-three states, four provinces and more than 400 organizations (see Figure 4.6).



## Value-Added Products to Drive Down Cost

While technology advances are being pursued to decrease the cost to capture and store CO<sub>2</sub>, there are opportunities for the utilization of CO<sub>2</sub> to help reduce CCS costs as an interim solution in moving toward full-scale storage. Enhanced oil recovery (EOR) is currently the largest and most profitable market for CO<sub>2</sub>.<sup>12</sup>

A significant number of the oil reservoirs in the lower 48 are amenable to CO<sub>2</sub>-EOR. In fact, 205 out of the 217 large reservoirs of the gulf coast hold as much as 17.7 billion barrels of 'residual oil in place' (ROIP) which is favorable to CO<sub>2</sub>-EOR.<sup>13</sup> Crude oil production includes three phases: primary, secondary, and tertiary (or enhanced) recovery. Primary recovery, using natural pressure, produces about 10% of a reservoir's original oil. Secondary recovery can access 20%–40% of oil using injected water or gas. Tertiary, or EOR, techniques can increase output to 60%. As an example, the Dakota Gasification Company's Great Plains Synfuels Plant in Bismarck, North Dakota, has been capturing more than 1.5 million tons of CO<sub>2</sub> per year from a coal gasification plant and selling it for use in EOR for more than fifteen years. With technical validation and assessment, residual oil zones may offer a new opportunity for combined oil production and CO<sub>2</sub> storage.<sup>14</sup> However, additional research on technology and techniques of surface and groundwater monitoring and storage verification for anthropogenic CO<sub>2</sub> used for EOR is necessary for widespread adoption. Other CO<sub>2</sub> utilization options include mineralization and incorporation into building and construction materials (i.e., calcium carbonate or magnesium carbonate), CO<sub>2</sub> curing of concrete products to conserve energy and capture CO<sub>2</sub>, and conversion into plastics and polymers. In addition, CO<sub>2</sub> can be used to promote indirect carbon storage through enhanced photosynthesis of algae for biofuels.

### Emerging Opportunities

CCS RDD&D activities in the United States have historically focused on new-build coal-fired power plants, but there is opportunity in broadening this focus. All ongoing CO<sub>2</sub> storage and many CO<sub>2</sub> capture-related activities are applicable to CCS retrofit of existing coal power plants, natural gas-fueled power plants, and application to large industrial facilities.

**Retrofit of plants with CCS technology:** Post-combustion capture technologies represent the greatest potential for CCS retrofits and the development of second-generation and transformational CO<sub>2</sub> capture retrofit technology could enable the continued use of these existing assets with simultaneous reduction of CO<sub>2</sub> emissions. Existing post-combustion systems make use of processes such as amine-based scrubbing that can achieve CO<sub>2</sub> capture rates of 90% or more from flue gas. These are capital intensive and require significant thermal energy to drive the solvent regeneration process.<sup>15</sup> Nearly all of the current global growth in coal electric power generation is in non-OECD countries, creating a large, coal-based capacity projected to be less than twenty years old in 2030.<sup>16</sup> Close collaboration with China and India in demonstrating coal CCS retrofit technologies in those countries would support achievement of global climate goals.

**Natural gas plants with CCS:** CCS-based RDD&D has advanced the field of carbon capture for all fossil fuel applications. The technology transfer to natural gas for both new plants and retrofits would be relatively straightforward, though those plants will pose challenges due to lower concentrations of CO<sub>2</sub> (3%–4%) in the flue gas that could increase capture cost/tonne CO<sub>2</sub>, and greater oxygen concentrations which can lead to degradation of solvents. Large-scale pilot test and demonstration projects are a natural next step in the application of CCS technologies to natural gas processes. With the abundance of natural gas from both conventional and now unconventional sources and the tightening environmental standards, natural gas plants are replacing many aging coal plants in the United States. Europe and other parts of the world, in collaboration with industry, are developing and demonstrating first- and second-generation carbon capture technologies for full-scale, natural gas-fired units.

**Industrial plants with CCS:** Industrial CO<sub>2</sub> emissions are produced both directly from fossil fuel combustion and indirectly from the generation of electricity that is consumed by industry. In the United States, as much as 27% of CO<sub>2</sub> from fossil fuel combustion in 2013 was from the industrial sector.<sup>17</sup> This is recognized as an area with potential for CCS application. The IEA projects that CCS in industrial applications can reduce CO<sub>2</sub> emissions by up to four gigatons (Gt) annually by 2050. Achieving this would require 20%–40% of all industrial and fuel transformation plants to be equipped with CCS by 2050.<sup>18</sup> Some industrial plants, such as ammonia

and natural gas processing, produce high purity CO<sub>2</sub> streams that will enable lower capture cost and may already deploy carbon capture and separation as an inherent part of the process. However, other industrial CO<sub>2</sub> emissions sources such as cement, iron/steel, and refinery hydrogen production are attractive targets for advanced CO<sub>2</sub> capture technologies that will also provide greater opportunities for other technologies to contribute to overall CO<sub>2</sub> mitigation. For example, RDD&D to reduce the cost of oxygen used in gasification and PC oxy-combustion could also benefit potential use of oxygen in cement kilns, refinery fluidized catalytic crackers, and blast furnaces. The challenges for industrial processes are due to the smaller equipment sizes and reduced economies of scale, which can increase capture costs compared to power plant applications.

**International cooperation addressing near-term CCS challenges:** International collaborations offer opportunities for sharing data, testing transformational CCS technology, and demonstrating technologies. Activities like the International Test Center Network<sup>19</sup> facilitate the exchange of knowledge and expertise among the world's carbon capture test centers. These test centers, which are located in the United States and other countries, enable long-term, independent validation and verification of advanced capture technologies under real-world conditions, and thus play a vital role to bridge the gap between R&D and commercial deployment. International collaboration will likely play a key role in integrated demonstrations. Large-scale CCS demonstrations are complex and expensive, with long lead times. Working through international partnerships such as the Climate Change Working Group,<sup>20</sup> China, and the United States have agreed to coordinate on large-scale demonstrations for both CO<sub>2</sub>-EOR and deep saline reservoir storage.

A great deal of progress has been made in advancing the state-of-the-art for CO<sub>2</sub> storage through RDD&D and the RCSP activities, which have culminated in ongoing million tonne CO<sub>2</sub> injection projects. However, the high cost of CO<sub>2</sub> capture has resulted in most large-scale injections focusing on EOR applications, as opposed to the deep saline injections that will be necessary for the development of a large-scale global CCS deployment. It will be important to develop sustained million tonne/year CO<sub>2</sub> saline injection projects in the United States and elsewhere where advanced storage technologies can be tested. The twenty-two countries of Carbon Sequestration Leadership Forum<sup>21</sup> are engaged in an initiative to identify potential test sites. In November 2014, President Barack Obama and Chinese President Jinping Xi jointly announced that the United States and China will lead a major new carbon storage project based in China and work together on a new Enhanced Water Recovery (EWR) pilot project to purify saline water extracted to control formation pressure during the process of injecting CO<sub>2</sub> into deep saline reservoirs.

#### 4.2.2 Nuclear Power

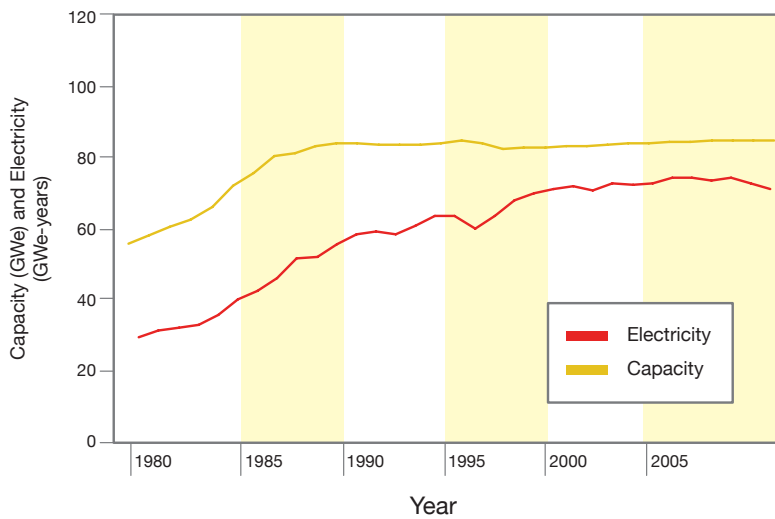
Nuclear power provides 19% of the electricity in the United States and 60% of the non-emitting generation.<sup>22</sup> The U.S. nuclear fleet consists of ninety-nine operating reactors at sixty-one sites providing approximately 99 gigawatts (GW) of capacity, as shown in Table 4.2. Five reactors are also under construction. The operating plants have demonstrated a fleet-wide capacity factor of 89% over the last decade.<sup>23</sup> While the number of operating reactors

**Table 4.2** Nuclear Power Capacity and Production, 2010 and 2014

	2010	2014
Reactors	104	99*
Capacity (GW)	101.2	99.2
Generation (TWh)	807	799
Capacity factor	91.1%	91.1%

\*Value from 2015 (100 reactors were operating in 2014.)

All 2010 data and 2014 capacity and capacity factor data are from EIA *Electric Power Monthly*, Feb 2015, Table 8.1; Generation data for 2014 and reactors in 2015 from World Nuclear Association, *World Nuclear Power Reactors and Uranium Requirements*, June 2015 (<http://www.world-nuclear.org/info/Facts-and-Figures/World-Nuclear-Power-Reactors-and-Uranium-Requirements/>).

**Figure 4.7** U.S. Nuclear Capacity and Generation Since 1980

Even without additional new builds, the capacity and generation of nuclear power continued to increase due to power uprates and improved efficiencies.<sup>26</sup>

stainless steel canisters placed in concrete casks prior to the anticipated eventual disposal of nuclear waste in a geologic repository.<sup>24</sup>

Nuclear power technology has attributes that make it attractive as a significant contributor in a transition to a low-carbon electricity system. Nuclear plants can provide significant quantities of baseload electricity production—a single 1,000 MW reactor can generate around eight million megawatt hours (MWh) of electricity annually without emission of GHGs. IEA's *World Energy Outlook 2014* forecasts global nuclear capacity as more than doubling by 2040 in its 2°C climate stabilization scenario. Reaching this level would entail deployments of up to 30 GW per year by the end of the next decade,<sup>25</sup> rates that have been seen historically but not in recent decades.

For nuclear energy to fulfill this potential, it must simultaneously address four key challenges that would otherwise limit its ability to widely expand. First, reactors must be recognized by regulators and the public as being a technology that will not pose a danger to nearby communities. This has been a primary driver for technology development for new nuclear reactor designs, a concern that has been heightened in the aftermath of Fukushima. Second, nuclear power plants must be economically attractive for companies making decisions about their generating portfolio. Nuclear plants require very large capital investments that can pose a significant financial risk for many companies. Advanced nuclear designs seek to create reactors that are more economical to construct, operate, and eventually decommission. Third, nuclear fission produces radioactive wastes that must be safely managed over a very long time horizon. While some nations have made progress on waste management either through recycling used nuclear fuel (UNF) or advancing geologic repositories for permanent disposal, the deployment of full-scale approaches to address this issue has proven difficult in many countries including the United States. Fourth, the widespread deployment of nuclear technology must not result in the proliferation of nuclear weapons. This is a particular concern with technologies used to produce nuclear fuel.

The RDD&D needed to address these challenges and enable continued nuclear deployment vary in relation to the time horizon of different nuclear technologies. The construction of large light water reactors (LWRs) that feature advanced safety attributes is underway, as are efforts to reduce costs that could expand their market potential. Small modular reactors (SMRs) currently being evaluated by the NRC seek to extend the safety

has not increased for the last few decades, through power uprates and efficiency gains the contribution of nuclear energy to clean electricity generation continued to increase until 2014 (see Figure 4.7). As the new reactors start operation, the contribution of nuclear power will increase. The fuel cycle that supports these reactors is built around low-enriched uranium oxide fuel that will reside in the reactor for four to six years before being removed. Slightly more than 2,000 tons of used fuel are generated each year by the entire fleet. It is first stored in pools of water until it has cooled enough to be air-cooled above ground in welded

and economic attributes of LWRs with the intent of commercial operation by the mid-2020s. Looking toward the 2030 time frame, RDD&D efforts are underway to develop advanced reactor designs that will enable new fuel cycles and widen the range of commercial applications for nuclear power—perhaps to be followed by fusion technologies (addressed in Chapter 9). Research on advanced reactors is an international endeavor, and collaborations such as the Generation IV International Forum have been established to leverage RDD&D capabilities. Fuel cycle RDD&D is to be pursued to facilitate the management of nuclear waste, while addressing concerns about proliferation. New approaches to integrate nuclear power are being investigated to allow better alignment with variable generation through more flexible operations. These will be addressed in greater detail below and in technology assessments.

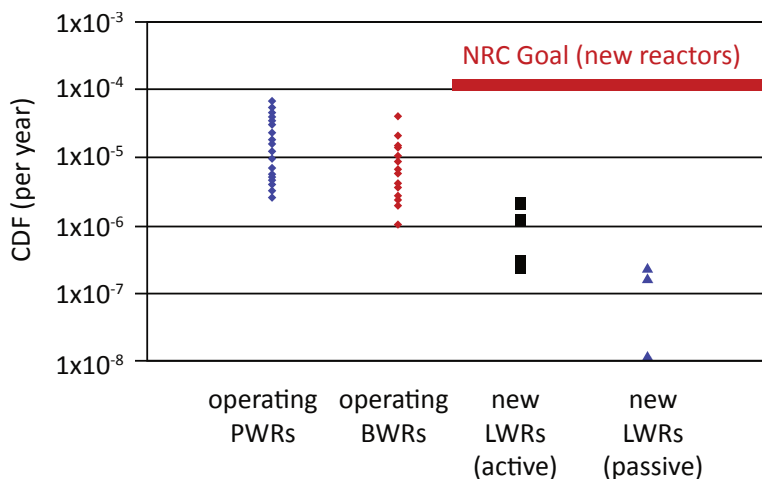
### Light Water Reactors

The predominant nuclear reactor technology is the LWR. In addition to the ninety-nine reactors in the United States, LWRs represent 259 of the 340 reactors deployed elsewhere in the world, as well as sixty-two of the sixty-nine units under construction.<sup>27</sup> LWR technology has seen consistent improvement from the current fleet through the reactors being developed today. In most electricity generation technologies, comparable technological advancements can be seen in reductions in cost or improvements in performance that translate into better economics. While there have been enhancements in LWRs that have translated into improved economics, a second dimension of advances is aimed at improving the safety performance of nuclear reactor systems. A key metric to

measure safety performance is the core damage frequency (CDF) from internal events, as estimated through the probabilistic risk assessment methodology. Figure 4.8 shows that the effort being put into new designs, especially the passively safe LWRs, reflects significant improvements in the safety assessment of the reactors.<sup>28</sup> Additional RDD&D is underway investigating novel fuel options with enhanced safety characteristics (shortly referred to as accident tolerant fuels) and improved performance under normal operations.

**Figure 4.8** Core Damage Frequency (CDF) Estimates of U.S. Reactor Types

Credit: U.S. Nuclear Regulatory Commission



Values for new light water reactor designs with more passive safety features are one to three orders of magnitude lower.

### Current LWR Fleet

The current fleet of LWRs was built during a period in which reactor sizes escalated quickly. The oldest units in the fleet entered service before 1970 and are on the order of 600 MWe, though the units were quickly scaled up to over 1,000 MWe by 1978. Reactors have been deployed in both single- and multi-unit power plants ranging up to 4,000 MWe in total. These reactors (generally referred to as Generation 2 reactors) featured little standardization and increasing costs as designs became increasingly complex to enable larger capacities and respond to changing safety requirements. Though a downturn in the reactor orders began in the wake of the recession in the late 1970s, no new orders were placed following the accident at Three Mile Island though some of the units that were under construction were eventually completed.

The operational performance of the fleet was mediocre through the 1980s with capacity factors averaging 60% for the decade. Improved management and better fuels enabled a steady improvement in performance with capacity factors more than 88% by the late 1990s.<sup>29</sup> Improved performance and profitability led to additional investments to add capacity at existing units (uprates) and enable the long-term operation of the plants beyond the original forty-year license. The increased expenses to respond to newer safety and security requirements have put economic stress on plants in regions with low wholesale power prices stemming from inexpensive natural gas and renewable penetration. Five reactors have closed in the last three years as a result of economic pressures.

The technical challenge to the continued operation of the current LWRs stems from the need to understand and assess the effects of aging in a nuclear reactor. Many of the major components in a nuclear plant can be replaced as they wear out, but that is not the case for the entire system. DOE conducts cost-shared RD&D to understand the material degradation characteristics of the reactor pressure vessel and structural components under a high-temperature radiation environment. The experimentation and modeling done in this work will inform the analysis to determine the feasibility of extending reactor operation beyond the sixty years for which seventy-one of the U.S. reactors have already been licensed to operate.<sup>30</sup> If all of the reactors in the U.S. fleet operate for sixty years, the first units will begin retiring by 2030, and only a handful will remain after 2050.

#### *New Builds*

Four of the five reactors being built in the United States are modernized LWRs sold by Westinghouse as the AP1000. These Generation (Gen) 3+ reactor designs offer improved safety and economic attributes. These designs build, in part, upon R&D sponsored by DOE in the 1980s and 1990s, as well as DOE financial support to reach commercialization by completing the licensing process. In addition to the reactors being built in the United States, four more AP1000s are under construction in China with additional units expected.

A key safety advance for Gen 3+ designs was to simplify the safety-related systems and rely more on natural phenomena, such as gravity and natural circulation to ensure reactor cooling. This design approach minimizes the number and complexity of backup safety systems and substantially reduces the number of actions that an operator must take to ensure cooling in accident scenarios.<sup>31</sup> Rather than rely upon pumps that require electrical power to operate emergency cooling systems, water will circulate as a result of natural forces thereby obviating the need to keep pumps operating if external power is not available.

These designs are still large reactors and though the simplification of key systems has reduced costs, they are still expensive to build. All deployments of the 1,100 MWe AP1000 have been in two-unit configurations, while other systems such as GE Hitachi Nuclear Energy's are more than 1,500 MWe. With overnight construction costs in excess of \$4,000/kWe, the total investment cost of a new Gen 3+ plant can be in excess of \$10 billion. The development priority for the Gen 3+ systems is to reduce the costs to make them more economically attractive. The AP1000, in particular, has attempted to build upon modular construction techniques that enable more work to be performed away from the reactor site with major components manufactured in factories and delivered to the plant site. Supply chain issues have inhibited fully realizing the promise of this approach in the first Gen 3+ units being built in the United States. The identification of RDD&D opportunities to reduce construction costs is inhibited by the lack of publicly available data on cost components that would enable a more granular understanding of where RD&D could provide significant benefits. An effort to assess the costs of new nuclear plants would contribute to energy analyses and RD&D planning.

#### *Small Modular Reactors*

If the key advance with Gen 3+ designs was to take advantage of natural forces to enable the inclusion of passive safety systems, then SMRs are an extension of this approach that result in a different way of thinking about a nuclear power plant. Light water-based SMRs reduce the reactor capacity (small core) and increase

the availability of water to make it even easier for the reactor to remain cooled in upset conditions. Some of these concepts, such as the NuScale design, go so far as to rely upon natural circulation for normal operations as well, eliminating the need for pumps entirely along with any risk that might come if they failed to work. Furthermore, key components that are external to the reactor in large designs, such as the steam generators and pressurizer, are integrated into the reactor vessel in many of the SMR designs, eliminating the possibility of certain failure modes such as large piping breaks that would inhibit the ability to cool the reactor fuel. In general, in the case of a potential upset condition in an SMR, the accident would progress more slowly due to the ability to cool the core with the relatively larger water volume, require few, if any, operator actions, and result in a lower off-site radiation dose due to the smaller radionuclide inventory. The smaller physical size of these units also permits a re-evaluation of how security at nuclear plants would be maintained. Many SMR designs feature below-grade construction to reduce the accessibility to the plants and to provide additional barriers to external threats. The principal challenge for SMRs is to determine whether power plants with smaller reactors can be built and operated at a cost that is economically attractive.

### High-Temperature Reactors

This category of reactors would be operated at high temperatures that would permit more efficient generation of electricity. These designs would convert about 50% of the thermal energy into electricity compared to the 33% for LWRs. An additional potential market could be opened by new plant designs in a nontraditional application of using nuclear power for industrial process heat needs. Some industrial process heat applications require temperatures substantially above the 300°C–325°C outlet temperature of today's LWRs. High-temperature reactors could be deployed to meet more than 600 GW-thermal (more than 25%) of this process heat demand enabling the displacement of the emissions associated with this production.<sup>32</sup> Achieving higher outlet temperatures requires switching to a new coolant technology using gas, liquid metal, or molten salt. With these coolants, it may be possible to achieve outlet temperatures ranging from more than 500°C for liquid metal coolants to more than 900°C for helium or molten salt coolants.

Achieving high temperatures requires the development and qualification of fuels, materials, and instrumentation, particularly at the higher end of the temperature range. Ongoing research to qualify high temperature fuels and the graphite applicable to some of the designs is scheduled to be completed in the 2020 to 2022 time frame with additional testing and experimentation to follow. In addition, the use of coolants other than water will require the advancement of a variety of plant components and systems such as electromagnetic pumps for liquid metal coolants, compact heat exchangers for gas coolants, and chemical purification systems for molten salt coolants. These factors will impact the licensing process, including the current codes and standards.

### Fast-Spectrum Reactors

Some advanced reactor technologies aim to change the reactor design to enable different characteristics of the fuel to run the reactor and to alter how the irradiated fuel is managed after it is removed. Fast reactors enable approaches that could reduce the waste disposal challenge by eliminating materials that provide long-term disposal issues. Transmutation is a process of turning some of the chemical elements in used nuclear fuel into elements with more desirable disposal attributes,<sup>33</sup> while keeping the fissile and fertile materials within the fuel cycle. Because of their neutronic characteristics, fast reactors make it easier to use recycled actinides in the fuel.<sup>34</sup> These approaches would produce power from fissile and fertile uranium and transuranic elements that otherwise would have required permanent geologic disposal. This category of reactors includes the more mature sodium-cooled fast reactor and the less mature lead-cooled fast reactor and gas-cooled fast reactor.

Key areas of RD&D for future systems include the following: high-performance materials compatible with the proposed coolant types and capable of extended service at elevated temperatures; new fuels (especially fuels using recycled actinides); and claddings capable of withstanding irradiation at high burnup.

## Fuel Cycle

Nuclear fuel cycles encompass a number of system components and operational approaches, starting from the mining and milling of uranium, and ending with the sustainable disposal of used fuel and/or various waste forms. All elements of the nuclear fuel cycle are intended to support the commercial operation of nuclear plants and are critical to the sustainability of nuclear energy. A large number of technologies have been explored in the past, and based on the results of these studies and systems and options analyses,<sup>35</sup> DOE focuses on a number of activities that support the development and ultimate deployment of a sustainable fuel cycle.

**Uranium resources:** Historically, RDD&D on uranium resources has focused on improved methods for land-based uranium extraction and recovery of fissile isotopes from used fuel. Novel approaches of extracting uranium from seawater (which contains a large integrated quantity of uranium at very low concentrations) are currently under investigation.<sup>36</sup> Though uranium supplies have proven sufficient to date, if this technology proves to be economically feasible, it would greatly extend uranium resources worldwide. RDD&D work is continuing on advanced separation techniques that might enable economic recovery and possible recycling of key fissile isotopes and the removal of waste constituents for disposal.

**Waste management:** Nuclear waste management is a particular focus of DOE as the government bears the responsibility to safely manage these materials. The government strategy to address waste management<sup>37</sup> includes a call for a consent based siting approach for one or more interim storage facilities for spent nuclear fuel and the longer term development of a permanent geologic repository. A number of technical options have been explored for waste management, including using full recycle or limited recycle fuel cycles for transmutation of specific isotopes, developing waste forms for specific types of materials, used fuel storage, and used fuel disposition. To this end, DOE pursues a number of activities, including RD&D on separation techniques and advanced fuel forms for transmutation, waste forms adapted to these fuel cycles, and a safeguards development program, the latter in collaboration with the National Nuclear Security Administration, to support these initiatives. These RD&D activities are closely coordinated with the design and development of advanced nuclear reactors for energy production and waste management missions. Building upon decades of research into the safe long-term disposal of nuclear waste, DOE is also developing the technical basis for ultimate development of geologic repositories to be implemented as part of any future fuel cycle including the investigation of deep boreholes for certain types of material.

**Used fuel storage and transportation:** In response to the Administration's strategy, DOE has initiated a significant RD&D program on used fuel storage and transportation, including the characterization of used fuels and their behavior in long term storage media, and the development of logistics strategies for transportation, storage, (and ultimate disposal) of used fuel. This effort builds upon the commercial experience in moving used fuel between nuclear power plants to best manage the existing stocks.

## Hybrid Energy Systems

The increased introduction of renewable sources (especially wind and solar) into the electricity grid may require nuclear plants to interface with a very dynamic grid. Nuclear power plants built around current technology are not well-suited to vary their output in response to the conditions of the grid. In periods of low demand and high variable renewable generation, nuclear systems are challenged to respond in an economically efficient manner. This RD&D is aimed at developing technologies and control systems that can follow the demand. An alternative is to be able to switch between electric and nonelectric (process heat) applications while maintaining steady and economical reactor power levels. While this effort is being pursued with nuclear as the focus for the energy production, this technology could well be applied to other power types that are suited to run full-time, such as coal with CCS.



## Nuclear Energy Summary

The traditional approach to nuclear energy research is lengthy and expensive, discouraging most private investors from investing in innovative technologies without government support. To realize the full potential for nuclear technology development, it is important to create an RD&D paradigm that enables faster readiness for commercialization of innovative technologies. This will likely require the further development and demonstration of advanced reactor concepts before they will be adopted commercially. The RD&D paradigm also needs to be complemented by a consistent licensing paradigm that fosters commercialization of novel safe and efficient concepts.

DOE has recognized that demonstrations of nuclear technologies are often expensive endeavors and advanced modeling and simulation tools are being used in conjunction with smaller-scale, phenomenon-specific experiments informed by theory to reduce the need for large, expensive integrated experiments. Insights gained by advanced modeling and simulation combined with a strong verification and validation program can lead to new theoretical understanding and, in turn, can improve models and experimental design. Though the use of modeling and simulation may serve to reduce the need for experiments and demonstrations, it cannot supplant the need entirely. These facilities are beyond the capabilities of the private sector to develop and maintain. DOE maintains access to hot cells and test reactors as well as smaller-scale radiological facilities, specialty engineering facilities, and non-radiological laboratories. DOE core capabilities rely on irradiation, examination, chemical processing, and waste from development facilities. These are supplemented by university capabilities ranging from research reactors to materials science laboratories. However, not all capabilities exist within the United States. International partnerships have been developed to maximize the use of facilities in other countries that can be used to support RDD&D needs. The drive to develop advanced reactor designs may well require additional capabilities to test the fuels, coolants, and materials that will enable non-water reactor systems. DOE is assessing the future testing needs for advanced reactors and the attributes that a 21<sup>st</sup> century test reactor would need to possess to meet those needs.

### 4.2.3 Hydropower Technology

U.S. hydropower technology has provided reliable and affordable power for over a century, contributing on average 10.5% of cumulative U.S. power sector net generation over the past six and one-half decades (1949-2013).<sup>38</sup> With 78 GW of installed capacity and 22 GW of pumped-storage hydropower capacity, hydropower provides approximately half of all U.S. renewable power sector generation (47% in 2014),<sup>39</sup> and provides many strategically valuable ancillary benefits that are uniquely suited to support further integration of other variable renewable energy technologies.

#### Major Challenges

**Market challenges:** Hydropower development and operations are intertwined with water resources development and management, which presents unique deployment challenges among renewable energy sources. Metrics for sustainability of hydropower development and operations within this broader water resources context of the United States are neither well-defined nor universally accepted. In addition, competing uses for water resources besides hydropower—including species protection and restoration, drinking water supply, navigation, and recreational uses—impact hydropower development and operational decisions. Much of the existing hydropower infrastructure in the United States will evolve from an energy-production role to a mixed role of production and provision of ancillary services to enable integration of variable renewables. This mixed role for hydropower is at risk due to lack of investment in aging infrastructure and increasing environmental and multiple-use constraints on water releases. Large-scale pumped-storage development is constrained by the absence of market signals and assured revenue streams needed to support financing of initial construction costs.<sup>40</sup> Hydropower development has historically been a site-specific design, permitting,

construction, and commissioning process with little standardization to reduce costs and uncertainty of development. Addressing siting, permitting, and environmental concerns result in long planning cycles and time to deployment.

**Technology challenges:** Large hydropower turbine-generator technologies are highly optimized, robust, and cost-effective designs, with peak energy conversion efficiencies of more than 93%.<sup>41</sup> However, they require economies of scale for energy revenues to support the cost of civil works. Advancements for small-scale turbine-generators must reduce technology cost and enable more compact support structures and smaller physical and environmental footprints to achieve economic feasibility. The remaining hydropower potential in the United States is comprised primarily of small-scale development opportunities that will require such advancements. The environmental performance of turbine designs continues to improve, in the form of blade shape enhancements to reduce injury to fish and aeration into turbine flow passages to improve the water quality of releases. However, these evolving designs engender trade-offs between energy conversion performance, environmental performance, and technology cost that are not thoroughly understood. They also require field testing to validate their environmental performance and achieve acceptance.

### Current Status

Hydropower currently provides 7% of annual total U.S. electricity generation.<sup>42</sup> Pumped-storage hydropower provides vital grid reliability services for the U.S. power system and enables grid integration of new variable resources. Approximately half of U.S. hydropower capacity is owned and operated by federal agencies. The remaining half is owned and operated by investor-owned utilities, state and municipal utilities, and independent power producers. This diversity of ownership requires active cooperation among stakeholders to identify and accelerate technology advancement opportunities and to coordinate water management and hydropower scheduling in multiple U.S. river basins.

### Factors Driving Change in Hydropower Technology

Environmental impact mitigation remains the overarching factor that drives hydropower technology advancement. Continued operation of existing facilities and new deployment will depend upon demonstration and acceptance of environmental mitigation technologies for facilities of all sizes—within the turbine and external to the turbine. Future drivers for hydropower and water storage could be impacts of climate change, with potentially increased water shortages—especially in the western states. There is approximately 65 GW of undeveloped stream resource hydropower potential in the United States.<sup>43</sup> Much of this potential capacity will require low-cost turbines operating at less than twenty-five feet of elevation difference. Small hydropower technology must become less expensive to manufacture, install, and operate if it is to see widespread deployment. Traditional powertrain, powerhouse, dam, and reservoir designs have footprints that may be too expensive with too many environmental impacts to be acceptable. There is opportunity to add up to 12 GW of capacity to existing non-powered dams.<sup>44</sup>

### Hydropower Technology RDD&D Opportunities

With technology innovation, cost reductions, and favorable market mechanisms, hydropower could substantially contribute to emissions reductions of CO<sub>2</sub> and criteria pollutants as a substantial part of the U.S. power portfolio. Design, siting, and operation will also need to take into account potential changes in precipitation and evaporation under climate change. Technology RDD&D can help to sustain and enhance existing hydropower capabilities and achieve market-competitive LCOE for new hydropower development in the following four areas:

**Integration of environmental mitigation technology into turbine designs:** Environmental performance optimization requires advanced computational models of flow dynamics, fish kinematics, and gas transfer within turbine flow passages, as well as laboratory and field scientific experiments to inform those models. Such design tools will require advanced physics-based turbulence modeling and will need high-performance computing (HPC) power to incorporate fish passage and water quality objectives into the turbine design process.

**Advanced powertrains:** Innovations can reduce direct costs of low-head turbine components, as well as reduce the physical footprint of small low-head turbines that influence overall costs and environmental impacts of low-head hydropower project development. Key areas of interest include advanced materials and manufacturing for powertrain components, innovative hydrodynamic and mechanical concepts to reduce integrated turbine-generator size (diameter and length) and increase speed, embedded condition monitoring sensors, and powertrain design innovations that afford flexibility in selection of design objectives such as initial cost minimization, efficiency over a range of head and flow rates, and durability or ease of replacement.

**Market acceleration and deployment:** Opportunities exist for reduction of the cost and duration of market barriers, including fish and wildlife, environmental, and multiple-use concerns such as navigation and water supply. Potential market barrier technology solutions include: a) standardized technology packages and site civil layouts to reduce the uncertainty and complexity of environmental and safety reviews for new development, and b) decision support tools that integrate fish passage, water quality, and other environmental objectives more robustly into hydropower and power system scheduling.

**Advanced grid integration:** Large-scale studies of power systems can choose to include hydropower and pumped-storage facilities as a part of solutions to integrate variable renewables into the grid. The capabilities and operational constraints of existing and future hydropower technologies must be accurately represented in such studies and within the operational and planning models that electric utilities and other stakeholders rely upon for decision making. Further, the impact of altered operational strategies for hydropower will have operations and maintenance (O&M) impacts and costs that must be projected as part of decision making and O&M planning.

#### 4.2.4 Wind Power Technology

Wind power has become a mainstream power source in the U.S. electricity portfolio, supplying 4.4% of the nation's electricity end use demand in 2014.<sup>45</sup> With more than 65 GW installed across thirty-nine states at the end of 2014,<sup>46</sup> utility-scale wind power is a cost-effective source of low-emissions power generation throughout much of the nation. There are more than 70,000 U.S. jobs in the wind industry at more than 500 manufacturing companies located in forty-three states in the U.S. wind energy supply chain.<sup>47</sup> Wind technology is cost-competitive today, without subsidization, in specific high wind speed locations with access to transmission capacity. The United States has significant sustainable land-based and offshore wind resource potential, greater than ten times current total U.S. electricity consumption, and various opportunities have been analyzed in future scenarios of high integrations of wind energy. Recent analysis highlights that through continued innovation in technologies and markets, wind technology can support large scale deployment in the U.S. power sector portfolio and could provide up to 35% of U.S. power requirements with high grid reliability by 2050.<sup>48, 49</sup>

##### Major Challenges

**Market challenges:** Varied wind capacity at traditional tower heights and electric energy value in utility markets across the U.S. strongly influence the competitiveness of wind power. With an increased ability to reach effective wind regimes, most regions would have wind energy capable of entering the regional market. Market valuation for carbon and criteria pollutant impacts would spur investment during periods of minimal demand growth. Increased transmission capacity from high quality wind resource locations is required.

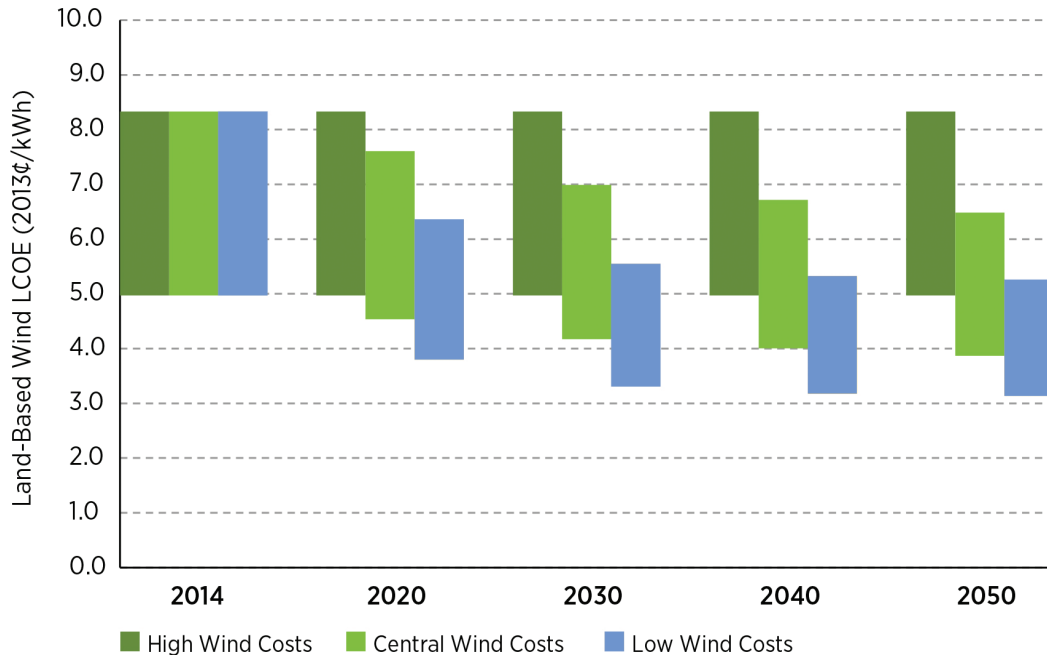
**Technology challenges:** Advanced understanding of fundamental atmospheric and turbine interaction physics, with optimized component designs, advanced sensors, higher hub heights, and plant controls have the potential to reduce LCOE.

### Wind Power Technology RDD&D Opportunities

Technology RDD&D opportunities to achieve market competitive LCOE for both land-based and offshore wind exist in the following five areas:

**Wind plant optimization:** Optimization of wind plant performance involves minimizing wind plant cost of energy through wind resource characterization, complex wind plant aerodynamics R&D, advanced plant-level controls development, improved numerical weather prediction and power forecasts, and improved design and operation standards to enhance plant reliability. Considerations include access to high resolution weather data and leveraging HPC assets for high-fidelity atmospheric and wind plant modeling and data integration efforts; comprehensive scaled and full-scale measurement campaigns to validate model development; holistic plant design that includes innovative plant control strategies to enhance energy capture, improve reliability, and reduce LCOE; and characterization of risk and uncertainty to maximize the financial investment potential of wind plants. Figure 4.9 illustrates the range of land-based wind LCOEs represented in the 2015 *DOE Wind Vision* scenario framework for the interior region and related changes from 2014 to 2050.<sup>50</sup> Data shown represent the plant-level LCOE, excluding potential intraregional transmission needed to move the power to the grid and interregional transmission to move the power to load.

**Figure 4.9** Land-Based Wind Changes in LCOE by Sensitivity (2014–2050, Interior Region)

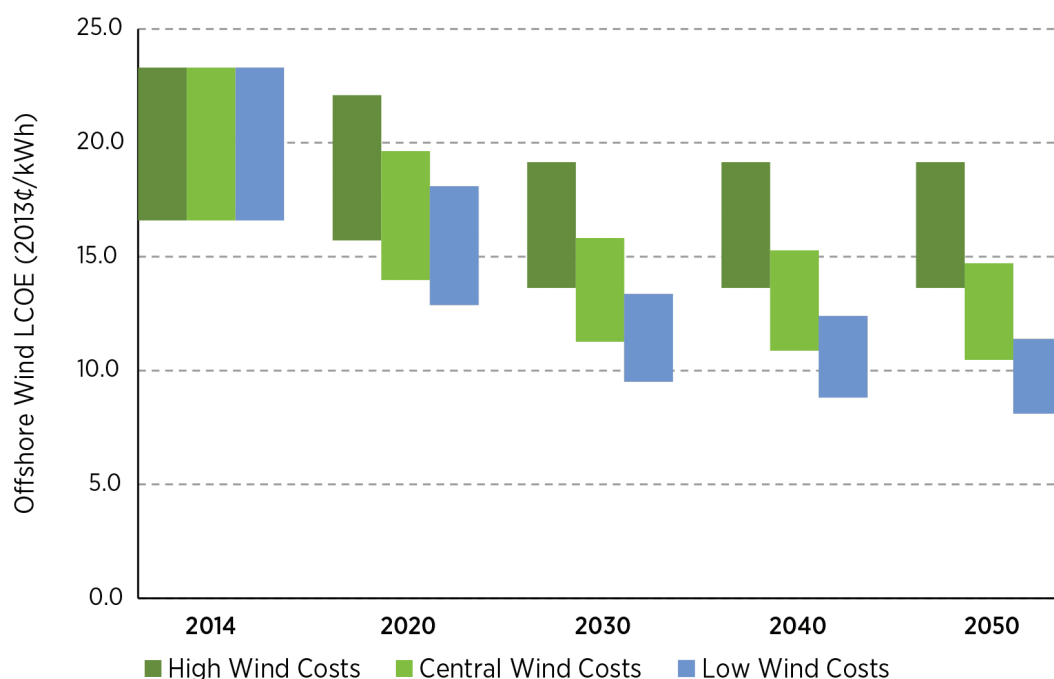


**Wind turbine components and materials:** Development of next-generation wind turbine components and materials requires research on advanced materials and key components to improve performance and reliability; development of new architectures for larger, light-weight turbines that reduce overall mass (reducing costs) and provide access to better wind resources (larger rotors, taller towers), and improved systems performance

(capacity factor); improvements in turbine cost, strength, weight, and fatigue to reduce operations and maintenance (O&M) costs and reduce the failure rate for large components, such as blades, gearboxes, generators, power electronics, and collection systems; and innovations to solve transport and installation cost limitations for large scale turbine systems and components. Research in advanced materials and innovative manufacturing techniques such as additive manufacturing that show potential to address issues specific to wind turbine components could be useful.

**Offshore wind technology:** Expedited development of a U.S. offshore wind energy industry requires advanced technology demonstration projects to validate innovative technologies to reduce LCOE. Figure 4.10 illustrates the range, as a function of wind resource quality and water depth, of offshore wind LCOEs in the 2015 *DOE Wind Vision* scenario framework, and how these LCOEs change from 2014 to 2050. Data shown represent the plant-level LCOE, excluding the marine export cable, potential intraregional transmission needed to move the power to the grid, and interregional transmission to move the power to load. In 2012, DOE funded development of proposals for seven offshore wind advanced technology demonstration projects.<sup>51</sup> Three project proposals were competitively down-selected in 2014 for continued funding and are required to be grid-connected and producing power by the end of 2017. These proposed projects would demonstrate features such as innovative, U.S.-developed twisted jacket foundations, hurricane-resilient design, and floating semi-submersible foundations. These projects are currently seeking financing. As of the end of 2014, the U.S. Department of Interior has issued seven commercial wind energy leases on the Outer Continental Shelf, including those offshore of Delaware, Maryland, Massachusetts, Rhode Island and Virginia.<sup>52</sup>

**Figure 4.10** Offshore Wind Changes in LCOE by Sensitivity (2014–2050)



**Market acceleration and deployment:** Reducing the cost and impact of market barriers that limit wind deployment involves resolution of considerations related to potential wildlife impacts, radar interference, workforce development, and public awareness. Opportunities exist to develop new scientific capabilities and technology solutions to enable sustainable wind deployment in more locations, including development of monitoring and mitigation tools necessary for the industry to obtain new permits required under the Bald and

Golden Eagle Protection Act; compliance with provisions of legislation such as the Endangered Species Act and offshore wind-specific legislation such as the Magnuson-Stevens Fishery Conservation and Management Act, and the Marine Mammal Protection Act; collaborations to help mitigate wind turbine interactions with civilian and military radar; and completion of national public acceptance baseline studies to provide the first quantitative assessment of the factors associated with public acceptance of wind energy development across the country.

**Advanced grid integration:** Optimizing grid integration (distributed and utility) and transmission for wind systems requires integration studies and operational forecasting tool development, including development of grid management and control systems that enable high penetrations of wind with high grid reliability. These tools would ensure reliable and economic system operations under high penetration levels of wind generation. Integration studies to fully understand the effect of wind on the U.S. power system would support the adoption of effective operational practices. Additional tool development would support planning and development of new infrastructure to allow access to high quality wind resources, evaluation of system response to uncertainties and electrical phenomena associated with wind power and development of operations practices for system operator use, and improvements to wind power controls to benefit grid power quality through activities such as voltage ride-through and frequency control.

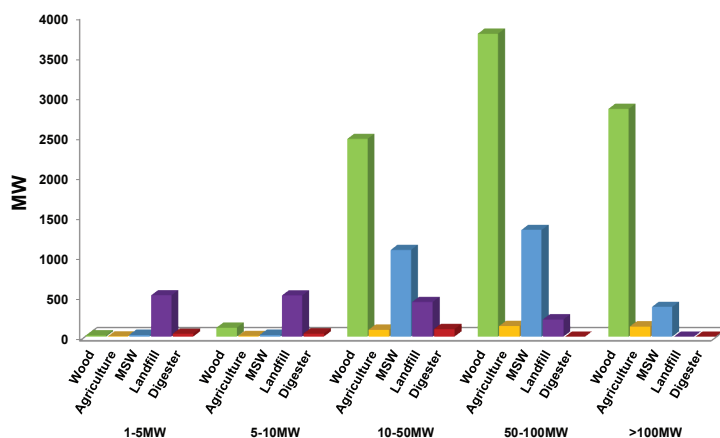
**Deployment:** Technology innovation and LCOE reductions, along with policy stability and transmission availability, are necessary to enable U.S. wind power to sustainably contribute to the reductions of CO<sub>2</sub> and criteria pollutants with reduced water consumption as a substantial part of the U.S. power portfolio. U.S. wind power could achieve up to 35% of U.S. power generation by 2050,<sup>53</sup> with benefits in reduction of lifetime GHG emissions of U.S. power generation; reduction of criteria air pollutants (e.g., sulfur oxides [SO<sub>x</sub>], NO<sub>x</sub>, and fine particulate matter [PM]<sub>2.5</sub>); reductions of water consumption by power plants; reductions in U.S. electricity rates; and additions of U.S. wind-related jobs in U.S. manufacturing, operations, and induced jobs.

#### 4.2.5 Biopower

The use of biomass to generate heat and power when coupled with CCS has the potential to be a significant source of carbon-negative renewable energy in the United States.<sup>54</sup> The IEA GHG R&D Programme found that biopower via gasification with CCS has the potential to reduce global GHG emissions by more than 2.5 Gt per year by 2050.<sup>55</sup> The forest products industry has been using biomass for heat and power for many decades, yet the use of biomass to supply electricity to the U.S. power grid and other applications is still limited, contributing 1.7% of total generated electricity in the United States according to the U.S. Energy Information Administration. In 2012, the nation-wide portfolio of biopower included 13.4 GW of installed capacity that

**Figure 4.11** Scale of Biopower Plants in the United States

Credit: National Renewable Energy Laboratory



produced 64 million MWh of electricity. These units are typically fired with opportunity fuels such as sorted municipal solid waste (MSW), agriculture and wood residues, sewage sludge, and pulp and paper industry black liquor. The heat produced by the combustion of this biomass is converted to steam, which is typically used to drive simple Rankine power cycles. The typical rating for these plants ranges from 2–100 MWe as seen in Figure 4.11.<sup>56</sup>

Biopower, as a baseload or dispatchable technology, has been considered as a potential electricity supply option in all past Intergovernmental Panel on Climate Change (IPCC) assessments. Under the right circumstances, biopower can accomplish three goals: 1) provide secure electricity using domestically-sourced biomass, 2) provide low-cost power when the cost of feedstock is competitive with alternative clean power generation sources, and 3) reduce atmospheric CO<sub>2</sub> emissions, compared to conventional fossil power, when biomass is obtained from managed plantations. Further, CO<sub>2</sub> that is taken up during the growth of biomass could be effectively fixed in a geological reservoir following combustion in a power plant equipped with CCS. If combined with CCS, the potential exists for reduction of atmospheric CO<sub>2</sub>.

## Major Challenges

Expansion of biopower in the U.S. is currently limited by the 1) availability and cost of feedstock, 2) reliability and consistent quality of feedstock, 3) combustion behavior in existing and advanced power plants, and 4) economies of scale (i.e., logistics) that are financially feasible with or without CCS. There are significant RDD&D opportunities to address all of these factors. Expansion of domestic biopower may be viable when biomass production in the United States increases significantly to ensure a reliable and economic feedstock source. Costs may also decrease with improvements to biomass production and supply logistics, or incentives to expand renewable energy, including the potential to reduce atmospheric CO<sub>2</sub> concentrations through biopower linked to CCS. Therefore, biopower will continue forward, drawing on the benefits of feedstock development for biofuels (see Chapter 7).

## Current Status

The present opportunity for utility-scale biopower with CCS involves co-firing in CCS ready coal-fired power plants where preconditioned biomass is fed along with coal into the power plant through the existing coal conveyance and milling/grinding operations, or through a dedicated biomass feed system that requires a retrofit of the existing plant burners and burner registers. The biomass must be pretreated to meet the combustor specifications with respect to particle size, grindability, heating value, and ash content. The industry has investigated a series of biomass/coal cofiring tests over the past twenty years. Boiler feedrates of 5%-10% biomass have been successfully demonstrated. Recent research evaluated the technical feasibility and the cost/benefits of co-firing biomass ratios up to 20% in boiler units rated up to 500 MWe. The projected LCOE was 18% higher for co-firing wood with coal in a typical power plant in Alabama, while the projected LCOE rose 54% when co-firing switchgrass with coal in a power plant in Ohio.<sup>57</sup> These cost increases resulted from the higher production and preprocessing costs of biomass.

## Factors Driving Change

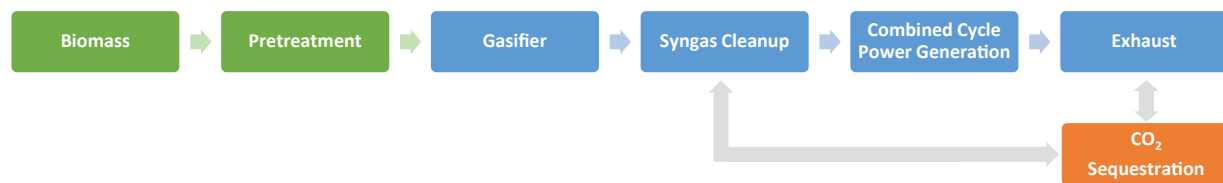
Given the promise of significantly higher efficiencies of combined gas combustion/steam turbine power cycles, combined cycle power generation is a target technology for biopower. Biomass gasification with CCS (BGCCS) could be developed in the 2025 to 2035 time frame by leveraging transformational technology supported by DOE's Office of Fossil Energy. The technology developed for coal could be progressively developed for biomass. As the amount of biomass cofiring increases, the coal conversion technology could be adapted or re-engineered to best exploit the characteristics of biomass feedstock in consideration of supply logistics and costs.

Biomass also offers the benefit of reducing SO<sub>x</sub>, NO<sub>x</sub>, and CO<sub>2</sub> emissions. Biopower plants release very little SO<sub>x</sub> because of the low sulfur content of biomass; biopower plants may apply a selective non-catalytic reduction system for NO<sub>x</sub> reduction. A mechanical collector and baghouse or electrostatic precipitator can be equipped to control PM emissions.<sup>58</sup>

## Technology RDD&D Opportunities

Among the more promising biopower with CCS technologies is integrated gasification/combined cycle with CCS. However, gasification of biomass is uniquely different from coal due to feedstock characteristics that impact feed injection into a pressurized reactor, higher biomass thermal conversion reactivity, and mineral matter behavior that may impact reactor fouling and slagging behavior. Biopower gasification could therefore leverage ongoing advanced combustion and gasification technology development for coal to address specific biomass technical development challenges. Feed systems and reactor design may be adapted and optimized for higher biomass feedrates, leading up to 100% biomass feed as seen in Figure 4.12.

**Figure 4.12** Biomass Gasification with CO<sub>2</sub> Capture and Combined-Cycle Power Generation



In consideration of the costs/benefits of BGCCS, feedstock format development should focus on the nominal supply for approximately a 200 MWe scale biomass gasifier. This scale of gasifier could meet the power requirements of a community of 100,000–200,000 persons, while co-producing a stream of CO<sub>2</sub> that is large enough to accomplish CO<sub>2</sub> storage. An LCOE of <\$75/MWh (2014\$) is a reasonable goal for utility-scale biopower. This amounts to approximately a 30% cost reduction from the average of current, limited-scale biopower co-firing studies.

### 4.2.6 Solar Power Technologies

For 2014, the EIA reports 9.3 GW of solar capacity and 18.3 TWh of generation, which does not include distributed systems (see Table 4.1). Other analysts report that solar energy provided 2% (20 GW) of the U.S. electricity-generating capacity in 2014, an eleven-fold increase since 2008, when distributed systems are included.<sup>59</sup> As Figure 4.13 shows, hardware prices for solar photovoltaics (PV) have dropped by more than 60% since 2010; however, additional reductions, particularly surrounding the “soft costs” of solar will be required for solar to be cost competitive with traditional energy resources. Solar is being deployed on both utility and distributed scales to provide peak load power, and concentrating solar thermal power (CSP) plants have been coupled with thermal energy storage to provide power into the evening hours. Challenges for solar technologies include reducing “soft costs” (e.g., permitting, financing, interconnection), improving integration into the grid, and increasing reliability, while continuing to lower hardware costs.

#### Major Challenges

Several challenges for solar PV exist across the technology spectrum. In the near term, continued module cost reductions of roughly 30% by 2020 and power soft-cost reductions indicated in Figure 4.13 would fuel continued growth of the industry.<sup>60</sup> In the longer term, increasing cell and module efficiencies and reliability, addressing integration-related challenges associated with high penetration, and streamlining installation through plug-and-play designs will be important. Improving the efficiency of converting sunlight to electricity has the benefit of both reducing the cost per watt (W) of PV modules and many soft costs as well. Building integrated photovoltaics (BIPV) also has the potential to reduce costs by reducing installation labor and building materials costs. Additionally, improving the life-cycle sustainability of



PV modules and system components, through either improved recycling techniques or modules made from earth abundant materials, will contribute to reducing the LCOE from PV systems and minimizing the long-term environmental impact of PV as the technology becomes more mature.

For CSP, the largest barriers to adoption are the high overall costs of the systems (in particular the collector field and thermal storage systems), and the cost of capital, which increases the overall LCOE

of a system. In the long term, technical challenges, including increasing the temperatures at which CSP plants operate, as well as the thermal efficiency of plant materials, such as heat exchangers and receivers, need to be addressed in order to significantly reduce costs. Additionally, increasing the lifetime of plant materials, either through more resilient materials or less corrosive heat transfer fluids, has the potential to significantly decrease O&M costs.

Finally, significant challenges exist with respect to integrating solar into the grid and reducing non-hardware “soft costs.” A combination of developments in PV and CSP technology and changes to the electric grid will need to be implemented in order to accommodate high penetration levels of solar on both distribution and transmission networks. Additionally, by developing innovative and scalable solutions to streamline processes and enable robust and sustainable market solutions, the soft costs of solar, which in 2012 represented 64% of a distributed PV system’s total cost, can likewise be reduced.<sup>61</sup>

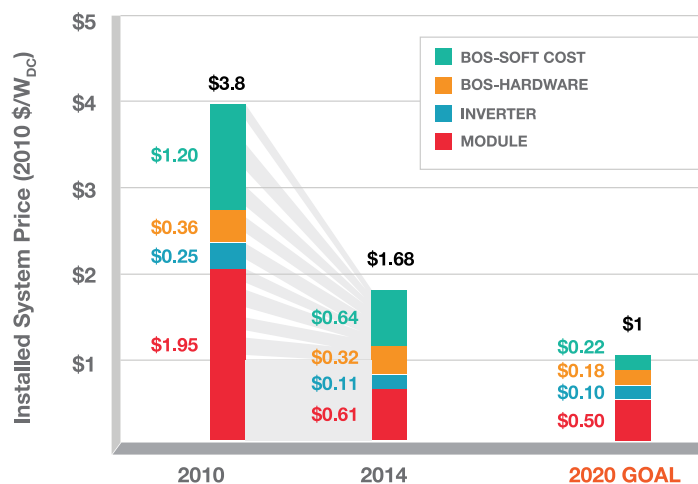
### Current Status

Solar deployment has been growing rapidly. From 2009 to 2014 the compound annual growth rate was 31%, and currently there is more than 20 GW of solar, 18.3 GW of PV and 2.7 GW of CSP, operational across the United States, representing about 2% of the nation’s generating capacity. These systems produce roughly 33 terawatt-hours (TWh) annually, about 0.9% of U.S. demand. Additionally, solar has proven to be a significant job creator. By the end of 2014, 174,000 workers in the United States were documented as employed by the solar industry.<sup>62</sup>

### Factors Driving Change in the Technologies

Significant investments in technology innovation, both in the private and public sectors, have advanced technology in recent years. The installed costs of a PV system declined more than 50% between 2010 and 2013. Module price reductions have played a key role in driving system-level cost reductions and overall growth in the PV market. Module prices declined from approximately \$1.95/W in 2010 to \$0.67/W in 2013 (66% reduction).<sup>63</sup> Financial subsidies and loan guarantees have made new CSP technologies commercially viable. Since 2010, four trough plants have come online, and the Ivanpah Project became the first operational CSP tower on a commercial scale in the United States.

**Figure 4.13** Utility PV Cost Reductions Since 2010 and Required Reductions for Cost Competitiveness (Source: SunShot 2014 Portfolio Book)



## Technology RDD&D Opportunities

Despite the rapid increase in deployment, significant work remains before solar achieves unsubsidized cost competitiveness with conventional energy sources. Novel processes for integrating solar generation into the grid must be developed. Supporting advanced inverter technologies, using next-generation storage, and developing electricity market solutions to ensure that solar energy can be utilized in a safe and reliable manner will become an increasingly important area of focus, as larger amounts of solar energy is deployed. “Soft costs” represent an increasingly large fraction of system cost (64% as of 2012) and must be reduced.<sup>64</sup> Hardware innovations also have the potential to significantly increase solar deployment. For PV, manufacturing improvements could increase efficiencies and reliabilities, and lower costs. CSP has a very large technical potential, as described below, but needs to realize significant improvements in performance and cost reductions to be competitive in the near-term. Lowering capital costs (e.g., heliostats field and construction costs) and increasing access to low cost financing would impact CSP deployment.

## Solar Power Opportunities

Solar power has a vast resource base and incredible technical potential. For example, PV panels on 0.6% of the nation’s land could supply enough electricity to power the entire United States.<sup>65</sup> PV is flexible in size and deployment and can be integrated into the built environment on building rooftops and facades, parking lots, and abandoned or degraded land close to population centers. Additionally, placing CSP in suitable and available land in seven southwest states could theoretically provide four times the current U.S. annual electricity demand. CSP also provides a stable and cost-effective form of energy storage, and it can cogenerate with on-site fossil energy sources.<sup>66</sup>

## Target Outcomes

Solar will become economically competitive nationally when the unsubsidized LCOE of solar energy reaches roughly \$0.06/kilowatt-hours (kWh) at the utility scale (PV and CSP), \$0.08/kWh at the commercial scale, and \$0.09/kWh at the residential scale.<sup>67</sup> In addition, finding ways to integrate variable generation into the electric grid will enable widespread deployment. This outcome would require installed costs to reach roughly \$1/W for utility-scale PV systems, \$1.25/W for commercial rooftop PV, and \$1.50/W for residential rooftop PV, and \$3.60/W for CSP (including thermal energy storage).<sup>68</sup> Since 2010, the industry has progressed by more than 60% of the way toward these targets, and costs continue to drop year after year.<sup>69</sup>

### 4.2.7 Geothermal Technology Development

Geothermal power taps into Earth’s internal heat as an energy resource. While geothermal power generation currently constitutes less than 1% of total U.S. electricity generation,<sup>70</sup> it is regionally much more significant in the western United States, supplying 4.4% of total system power in California in 2012.<sup>71</sup> Geothermal power plants have a small surface footprint and produce low-carbon baseload electricity. The challenges for geothermal power are to discover new resources, translate resources to reserves, lower early stage risk, and reduce costs in order to increase the scale of power generation and make geothermal a viable source of power in more regions.

Vast amounts of heat are contained in the interior of the earth from the slow decay of radioactive elements and the heat remaining from Earth’s formation. Specific locations have a favorable combination of high heat flow and natural fluid circulation that make them suitable for geothermal power generation. The naturally circulating, hot fluid can be tapped into to generate power in these naturally occurring hydrothermal systems. Enhanced geothermal systems (EGS) are engineered reservoirs created to produce electricity from geothermal systems that are not otherwise economical due to lack of water and/or permeability.<sup>72</sup> In an EGS, fluid is injected into the subsurface, which causes pre-existing fractures to reopen. This increases permeability

and allows fluid to circulate throughout the rock and transport heat to the surface, where electricity can be generated. The U.S. Geological Survey (USGS) estimates that there are nine gigawatt-electric (GWe) of identified geothermal resources and an additional 30 GWe of undiscovered geothermal resources.<sup>73</sup> With EGS, the USGS estimates a mean electrical power resource of 517 GWe in the United States.<sup>74</sup>

## Major Technological Challenges

In geothermal energy development, two areas are identified as major technological challenges: 1) developing the subsurface engineering technologies and practices necessary for economic deployment of EGS, and 2) reducing the cost and risk associated with accessing the subsurface through characterization technologies that can improve drilling success rates and/or developing technologies to directly reduce drilling costs.<sup>75</sup> The high upfront costs, particularly drilling costs, are a major challenge for geothermal development because they occur when risk is still high. The result is that it is difficult to obtain financing for new geothermal developments.<sup>76</sup> These challenges have close ties to those faced by other energy sectors that utilize the subsurface for fuel extraction or for storage and disposal of energy waste streams, leading to opportunities for cross-sector collaboration.<sup>77</sup>

## Current Status of Geothermal Technologies

The majority of the geothermal systems that can be readily identified by their surface expression have been developed or are in development. The future of geothermal in the United States lies in identifying “blind” hydrothermal systems through new innovative exploration technologies and in advancing technologies for EGS. Adopting technologies and practices from the oil and gas industry is a promising strategy to improve geothermal exploration. One example is translating the Play Fairway Analysis concept to inform the exploration decision-making process. The application of EGS techniques has been expanded from developing new geothermal sites to enhancing existing hydrothermal sites. Success has been achieved in stimulating noncommercial or “dry” wells within or on the margins of existing hydrothermal fields to increase their productivity and make them commercially viable.<sup>78</sup> These successes are an important step toward achieving the ultimate goal of EGS: to create a geothermal system where none existed before.

## Factors Driving Change in the Technology

The need to translate more resources to reserves, reduce early-stage risk, and lower costs for development are driving changes in geothermal technology. Some of the key areas of RDD&D that have the potential to impact geothermal deployment are: resource characterization and exploration technologies, purposeful control of subsurface fracturing and flow, improved subsurface access technologies, and additional value added to operations through mineral recovery and hybrid systems. The Frontier Observatory for Research in Geothermal Energy (FORGE) is a new DOE initiative that will address some of these areas. Informed by foundational Hot Dry Rock experiments<sup>79</sup> and the current DOE demonstration portfolio, DOE has launched the FORGE initiative, which will become a dedicated test site.

## Technology RDD&D Opportunities

To address the challenges summarized above RDD&D is needed in the following key areas:

- **Subsurface characterization:** Efficiently and accurately locate target subsurface geologic environments and quantitatively infer their evolution and enhance their operation over time. Advances in downhole tools that can withstand high temperatures (>300°C) could improve the ability to characterize geothermal systems. New technologies to measure stress in the subsurface are needed.

- **Accessing:** Safely and cost-effectively construct wells in challenging subsurface conditions. High-impact technology advancements, such as advanced and tailored drilling methods, new casing and zonal isolation materials, and high-temperature directional drilling could facilitate improvements for the geothermal and other sectors.
- **Engineering:** Create the desired subsurface conditions in challenging high-pressure/high-temperature environments. For EGS to succeed, methods are needed to create or enhance fracture networks that allow enough fluid flow through the subsurface to allow requisite production rates but avoid uneconomically rapid thermal drawdown.
- **Sustaining:** Maintain these conditions over multidecadal time frames throughout complex system evolution. The ability to control fluid movement in the reservoir is essential to EGS and will require advanced wellbore methods to control injected and produced fluids.
- **Monitoring:** Improve observational methods to advance understanding of the multi-scale complexity throughout system lifetimes. Improved surface-based and downhole diagnostics methods and tools (hardened for severe geothermal conditions) are being developed and are needed.

Another potentially important technology option is utilizing CO<sub>2</sub> as the geothermal working fluid, or heat transmission fluid; previous and current attempts to create and operate EGS in the United States, Japan, Europe, and Australia have all employed water. A number of studies indicate that CO<sub>2</sub> is superior to water as a heat transmission fluid, achieving somewhat larger heat extraction rates when the same injection pressure is applied. An ancillary benefit to CO<sub>2</sub> EGS is the potential for CO<sub>2</sub> sequestration as precipitated carbonate minerals and feldspar to clay conversion at the fringes of a CO<sub>2</sub> EGS reservoir. An anticipated RDD&D challenge associated with the use of CO<sub>2</sub> as a working fluid lies in the likely requirement that the reservoir needs to be completely dried before CO<sub>2</sub> is injected in order to avoid problems associated with the formation of carbonic acid.

#### 4.2.8 Stationary Fuel Cells

Fuel cells are well-suited to stationary applications because they are efficient even at small scale, have low emissions, are scalable from a few kilowatts (kW) to multi-megawatts,<sup>80</sup> operate quietly, have low maintenance, and can use a gamut of fuels (various hydrocarbons, hydrogen). Several types of fuel cells are applicable for stationary power generation, including polymer electrolyte membrane fuel cells (PEMFCs), phosphoric acid fuel cells (PAFCs),<sup>81</sup> molten carbonate fuel cells (MCFCs), and solid oxide fuel cells (SOFCs) (see Technology Assessment supplement for more information).

- PEMFCs are good for quick startup and transients and operate at 50°C–100°C, a relatively low temperature range with a solid electrolyte, conditions that reduce the risk of corrosion.
- PAFCs operate at 150°C–200°C and are more expensive than PEMFCs, but have increased tolerance to fuel impurities.
- MCFCs (600°C–700°C) are highly efficient with higher fuel flexibility than the previous two fuel cell types.
- SOFCs (500°C–1000°C) have even higher efficiency, scalability, and fuel flexibility, but their higher operating temperatures affect durability.

Both MCFCs and SOFCs can be integrated with a gas turbine in an ultra-high efficiency (>70%) combined cycle configuration. The challenge for fuel cells is achieving cost parity with conventional technologies through increased durability, higher power density, reduced cost of contaminants removal, and manufacturing cost reductions.

Distributed generation (DG) is an attractive pathway to fuel cells deployment with electric power applications (e.g., grid strengthening, prime power for data centers, and online backup power), and combined heat and power (CHP) for commercial, institutional, municipal, and residential buildings. The Technology Assessment discusses synergy with electrolyzers and reversible fuel cells for producing and using hydrogen in support of the electric grid.

## Major Challenges

Technical challenges, beyond the need to reduce capital costs,<sup>82</sup> are listed in Table 4.3.

**Table 4.3** Technical Challenges for Fuel Cell Types

Fuel cell (FC) type	Technical challenge
Polymer electrolyte membrane (PEMFC)	Very high cost for contaminant removal from fuel streams; durability needs to increase; efficiency needs to increase to MCFC and SOFC levels
Phosphoric acid (PAFC)	Low power densities; cost for contaminant removal from fuel streams; high cost of balance-of-plant; efficiency needs to increase to MCFC and SOFC levels
Molten carbonate (MCFC)	High system costs due to stack life and low power densities; cost for contaminant removal from fuel streams; high cost of balance-of-plant; long start-up
Solid oxide (SOFC)	Stack lifetime; performance stability (e.g., seals, interconnects, active materials); cost for contaminant removal from syngas; limited ability to thermal cycle; long start-up

## Current Status

Production costs have come down from \$6,000/kW in 2006 to projected high volume costs as low as \$2,400/kW<sup>83</sup> in 2013. Customers have realized up to 60% reduction in GHG emissions compared to coal power and 20% compared to natural gas combined cycle. Other benefits driving demand for fuel cell power include high electrical efficiency (>60% lower heating value [LHV] in some cases<sup>84</sup>), nearly silent and vibration-free operation, high reliability, and low maintenance. Grid-scale deployment started with Dominion's 14.9 MW fuel cell plant in Bridgeport, Connecticut. U.S. exports enabled the world's largest fuel cell park (59 MW) in South Korea.<sup>85</sup>

## Factors Driving Changes in the Technologies

Cost-effective gas cleanup is an increasing priority with the growing use of low-carbon biogas. For stationary PEMFCs, a growing market for PEMFC-based material handling equipment, backup power and fuel cell vehicles would synergistically accelerate the rate of manufacturing cost reduction. For grid modernization application, R&D is also needed on advanced sensors, controls, and associated system architectures needed to manage a diverse set of resources and grid assets.

## Technology RDD&D Opportunities

Table 4.4 shows the cost targets resulting in under \$0.10/kWh LCOE<sup>86</sup> for deployment in commercial and multifamily residential buildings.

**Table 4.4** Cost Targets versus Current Status – Medium-Scale (0.2–5 MW) Fuel Cells

	2020 targets	Current (2013) status
Installed costs	\$1,500/kW (natural gas) \$2,100/kW (biogas)	\$2,400–\$5,500 /kW <sup>87</sup> (natural gas) \$4,900 <sup>88</sup> –\$8,000/kW (biogas)
Durability	80,000 hours	40,000–80,000 hours (depending on fuel cell types)

For large SOFCs, targets for industrial-scale DG and utility-scale generation (natural gas, coal, etc.) include high-volume production at \$900/kW and durability >50,000 hours. SOFC power systems have the potential to achieve greater than 60% electrical efficiency and more than 97% carbon capture. The NETL projects that SOFC power systems could become cost-competitive by 2020.<sup>89</sup>

For the various fuel cells, RDD&D is needed on materials, stack components, balance-of-plant, and integrated fuel cell systems—targeting increased power density, lower cost, and enhanced durability, with an emphasis on science and engineering at the cell level and also on overall system integration.

While hydrogen production is covered in Chapter 7, high temperature fuel cells operating in trigeneration mode can also be used to produce hydrogen, heat, and power. However, cost reduction and durability, particularly in the case of internal reforming, need to be addressed. International collaboration should continue since progress is being made also outside the United States. Complementary activities should be pursued (e.g., codes and standards, demonstrations, and performance data collection and analysis of pre-commercial technologies).

#### 4.2.9 Marine and Hydrokinetic Power Technology

Marine and hydrokinetic (MHK) technologies convert the energy of waves, tides, and river and ocean currents into electricity. With more than 50% of the U.S. population living within fifty miles of the nation's coasts,<sup>90</sup> MHK technologies hold significant potential to supply renewable electricity to consumers in coastal load centers, particularly in areas with high costs of electricity. MHK resource assessments identify a continental U.S. technical resource potential<sup>91</sup> of up to 538–757 TWh of generation per year from ocean wave,<sup>92</sup> ocean current,<sup>93</sup> ocean tidal,<sup>94</sup> and river current energy.<sup>95</sup> For context, approximately 90,000 homes can be powered by one TWh of electricity generation each year.<sup>96</sup> A cost-effective MHK industry could provide a substantial amount of electricity for the nation due in large part to its unique advantages as a source of energy, including its vast resource potential, its close proximity to major coastal load centers, and its long-term predictability and near-term forecastability.

##### Major Challenges

The following describe the major challenges to commercial deployment of MHK technology in the United States:

- Capital cost reductions and performance improvements are challenges for MHK to be competitive on a regional basis. The high initial costs of today's MHK prototypes are due in large part to the cost structure per unit power generation.
- Cost-competitiveness of MHK energy will require that individual devices capture more than double the amount of energy than current prototypes for the same device size.<sup>97</sup>
- Lack of available test facilities, in particular multiberth, full-scale, grid-connected open water test facilities for wave energy devices, to support the anticipated acceleration in U.S. MHK market growth.
- Lack of scientific information, for example baseline environmental data, and high monitoring costs can drive environmental and regulatory expenses to 30%–50% of total early-stage MHK project cost.

##### Current Status

- While tidal barrage energy has been employed for several decades, overall MHK technologies are in the early stages of development, with a wide variety of designs and architectures.
- Despite a significant increase in renewables generation and a diverse set of MHK technologies, there are currently no commercial MHK technologies deployed in the United States.

- As of the end of 2014, four companies held licenses from the Federal Energy Regulatory Commission for MHK technology deployment projects, with eleven other projects in the development pipeline (holding a preliminary permit or in pre-filing for a license).<sup>98</sup>
- Internationally, the first phase of the Meygen tidal energy project in Scotland's Pentland Firth, with four turbines totaling six megawatts, is scheduled for commercial handover in the final quarter of 2016.<sup>99</sup>

### Factors Driving Change in MHK Technology

Improving performance and reducing cost through technology advancements, demonstrating reliability and survivability, and addressing uncertainties regarding potential environmental impacts in order to reduce permitting barriers are key focus areas in reaching commercialization.

### MHK Power Technology RDD&D Opportunities

MHK has significant opportunities to provide a substantial amount of electricity for the United States in areas where it is needed most. Opportunities exist for RDD&D in the technologies with the most abundant resources that have potential for techno-economic viability and can be deployed in markets with high energy costs, while supporting next-generation, game-changing technologies. Critical technology RDD&D can generate breakthrough technology innovations and identify the most promising ones, improve their performance, lower the costs, and accelerate their deployment. Opportunities for MHK RDD&D include the following four areas:

**Technology advancement and demonstration:** Provide the ingredients for and incentivize incubation of revolutionary concepts. Prove technical credibility, catalyze device design evolution, and optimize performance through, for example, application of optimized controls, power takeoff, and structure components to double annual energy production and increase availability.<sup>100</sup>

**Testing infrastructure and instrumentation:** Strengthen MHK device quality and reliability, provide affordable access to facilities for testing, and develop robust instrumentation and sensors.

**Resource characterization:** Classify the U.S. MHK resource, disseminate resource data among stakeholders, and develop numerical modeling tools to predict loading conditions. Quantify and classify environmental conditions to reduce siting risk.

**Market acceleration and deployment:** Environmental research and risk mitigation boost investor confidence and reduce regulatory barriers. Research of effects on aquatic organisms (blade strike, collision, entanglement, noise, electromagnetic fields, species behavior) and research of effects on physical systems (hydrodynamic and sediment transport dynamic modeling for both wave and current) are needed.

Specific opportunities for MHK power technology RDD&D include:

- Applied RDD&D to greatly improve today's technology through innovation in energy capture, operational efficiency, structural performance and reliability, and demonstrate capabilities through testing to prove readiness for early, near-term markets.
- Development of next-generation component technology designed specifically for the challenges of the marine environment. These technologies would drive the costs down for multiple energy conversion system solutions, including advanced controls to tune devices to extract the maximum energy from each sea state, compact high-torque, low-speed generator technologies, and corrosion- and biofouling-resistant materials and coatings.
- Development of fully-validated MHK open source advanced engineering/physics-based codes and design tools for modeling and simulation, and improved controls to spur innovation and collaboration in the MHK technology development community.

- RDD&D efforts to minimize the cost and time associated with permitting and deploying MHK projects, including RDD&D on new instruments to identify, mitigate, and prioritize environmental risks, providing data to accelerate permitting time frames and drive down costs, and engage in ocean planning.
- Provision of access to testing facilities that would enable a systematic progression toward commercialization, thereby reducing the cost and risk of technology demonstration for developers.
- Development of a wave classification scheme analogous to the resource classifications used by the wind industry. This would allow device developers to understand the operating conditions they would face in different regions and which regions to target for deployment in order to capture the maximum amount of energy with the minimum amount of load on the MHK device, maximizing the lifetime of the device and reducing LCOE and investor risk.

### 4.3 Creating Crosscutting Technology Solutions

As the industry develops to meet growing electrification and carbon reduction goals, there is a recognition of the value of increasing coordination, connections, and interdependencies. Opportunities exist in advancing common technologies, such as turbines and power cycles, in utilizing advanced capabilities, such as computing and advanced manufacturing, and also in sharing approaches, such as private-public and international partnerships. Technologies being developed for a specific energy source may be applicable to a broader range of energy systems. An example could be the hybrid energy systems presented in Section 4.2.2 that are being developed with a focus on nuclear technologies, but could well be expanded to address other thermal power sources.

#### 4.3.1 Advancing Common Technologies

Technologies that can be applied to electrical generators share a number of common challenges, which are being addressed by creative solutions that cross the boundaries of specific technologies. Improved energy conversion systems in thermal power, expanding subsurface knowledge and manipulation capabilities, and water usage technologies are a few examples.

##### Supercritical Carbon Dioxide in Thermal Power

The sCO<sub>2</sub> Brayton Cycle energy conversion system is an innovative concept that transforms heat energy to electrical energy through the use of a supercritical fluid rather than through steam and water. In this cycle, the sCO<sub>2</sub> is maintained near the critical point during the compression phase of the cycle. This allows a higher gas density, closer to the density of a liquid than of a gas, where compressor work is significantly reduced, with the potential to reach thermal efficiencies of 50% or greater. The significantly higher-efficiency power cycles of sCO<sub>2</sub> systems coupled with other technology attributes could result in large potential reductions in capital and fuel costs, decreased GHG emissions, and reductions in cooling water consumption within the energy industry, specifically in the fossil, solar, nuclear, and geothermal sectors.

RDD&D in sCO<sub>2</sub> has made progress, but there are significant technical challenges remaining. For example, determining the set of operational parameters, component designs, and system configuration that results in adequate efficiency for commercialization are major uncertainties that will require modeling, component research, and rigorous systems engineering. Critical technology and component development will require science investigation of the effects of unavoidable impurities in the sCO<sub>2</sub> working fluid, dynamic processes within the system, and pressure waves and acoustics.

To address the technical risks for scaling up to higher temperatures, RDD&D would normally be phased by demonstrating an operational model at temperatures up to 550°C. As the technology advances, enabling operational temperatures to increase beyond 750°C, potential market opportunities would expand further to include CSP and fossil fuel direct heating. Over the longer-term, as operating temperatures and scalability increase, potential market opportunities could grow to include large nuclear and fossil fuel plant designs.



## Advanced Combustion

While pressure gain combustion offers efficiency advantages, there are several challenges that must be overcome. Mechanical issues such as durability and integrity of valves and seals, thermal management (i.e., combustor cooling), and integration still need to be resolved. Fuel injection, fuel-air mixing, and control of the detonation wave/direction must be addressed. Significant testing at lab and bench-scale and scale-up to demonstration is a necessary part of the RDD&D process to realize the performance opportunity that this technology offers. DOE is beginning to pursue novel concepts and options to address these challenges. For example, Advanced Research Projects Agency-Energy (ARPA-E) had a project with Aerojet Rocketdyne on a rotating detonation engine combustor, which leveraged previous work under the Defense Advanced Research Projects Agency. Under the DOE Fossil Energy Advanced Turbines Program, two projects were awarded in fiscal year 2014 that will evaluate the technical and economic feasibility of pressure gain combustion and provide the technical basis for future development of the technology.

## Subsurface Technology RDD&D

Energy resources originating from the earth's subsurface provide more than 80% of total U.S. energy needs today. Finding and effectively exploiting these resources, while mitigating impacts of their use, is critical to the nation's low-carbon and secure energy future. Next generation advances in subsurface technologies will enable access to more than 100 GWe of clean, renewable geothermal energy, as well as safer, less environmentally-impactful, development of domestic natural gas supplies. The subsurface potentially provides hundreds of years of capacity for safe storage of CO<sub>2</sub> and opportunities for environmentally responsible management and disposal of hazardous materials and other energy waste streams. The subsurface can also serve as a reservoir for energy storage for power produced from variable generation sources, such as wind and solar.

RDD&D opportunities in wellbore integrity, subsurface stress and induced seismicity, permeability manipulation, and new subsurface signals could lead to a future of real-time control or "mastery" of the subsurface. Achieving this goal could have a transformative effect on numerous industries and sectors, impacting the strategies deployed for subsurface energy production and storage.

**Wellbore integrity:** Well integrity is regarded as the single most important consideration for protecting groundwater resources that coexist with oil and gas production. As hydrocarbon reservoirs are increasingly found in deeper and hotter locations, chances of seal integrity failure increase considerably. Wellbore integrity is also critical to ensure safe injection of CO<sub>2</sub> into the subsurface and to optimize geothermal energy generation. RDD&D aimed at new materials and practices associated with wellbores can address these challenges.

**Subsurface stress and induced seismicity:** Knowledge of the subsurface stress state is required to predict and control the growth of hydraulically-induced fractures, reopening of faults, and induced seismicity potentially associated with subsurface energy production, storage, and waste disposal applications. RDD&D on new tools and techniques for stress measurement will lead to improved understanding of risk to minimize uncertainties and lost opportunities to take advantage of the subsurface for energy production and waste storage.

**Permeability manipulation:** The challenges involved in selectively and adaptively manipulating permeability in the subsurface result from the difficulty of characterizing the heterogeneous deep subsurface and incomplete understanding of the coupled processes related to fluid flow, geomechanics, and geochemistry over scales from nanometers to kilometers. RDD&D into new technologies and techniques for selectively enhancing, reducing, and eliminating permeability in the subsurface can contribute to all subsurface energy sectors. In particular, technologies to minimize water use and reduce risk for induced seismicity when operating in the subsurface present significant opportunity.

**New subsurface signals:** New signals have the potential to transform our ability to characterize subsurface systems by focusing on four areas of RDD&D: new signals, integration of multiple datasets, identification of critical system transitions, and automation. A focus is on co-characterization of physical, geochemical, and mechanical properties using multiple datasets and on leveraging advancements in materials science, nanomanufacturing, and HPC.

## Energy-Water Nexus

Water is used in all phases of energy production and has direct links with two of the nation's energy-linked challenges: environment and security. Thermoelectric power generation accounted for 45%, or 161,000 million gallons per day, of the water withdrawals in the United States in 2010.<sup>101</sup> Surface water withdrawals accounted for nearly 100% of thermoelectric-power withdrawals, and 73% of the surface water withdrawals were from freshwater sources. With climate change affecting precipitation and temperature patterns in the United States and population growth and migration anticipated to continue in arid regions such as the Southwest, managing energy and water resources will increase in complexity. Although there is significant uncertainty regarding the magnitude of climate effects on water availability, predictability, and temperature, shifts in precipitation and temperature patterns will likely lead to changes in water availability that may impact hydropower and thermoelectric generation and biofeedstock production. For the electric power sector, RDD&D opportunities in utilization of waste heat, advanced cooling, hybrid cooling, and water treatment could reduce freshwater needs and potential vulnerabilities to changes in climate conditions.<sup>102</sup>

**Utilization of waste heat:** According to 2011 data, only about 30% of the energy content of the fuel in a conventional steam power plant emerges from the plant as electricity. The remaining 70% is dissipated through losses to flue gases or is rejected through cooling operations at thermoelectric power plants.<sup>103</sup> Improvements in the efficiency of power cycles can reduce waste heat generation. Combined cycle power plants can have efficiencies close to 60%, and advances in thermoelectric materials and heat exchangers can increase utilization further. Numerical models have shown that energy recovery systems using solid-state thermoelectric power generators could increase overall power plant output by approximately 6.5%.<sup>104</sup>

**Advanced cooling:** Once-through cooling systems accounted for 94% of thermoelectric water withdrawals in 2010. Although cooling towers withdraw far less freshwater than once-through cooling, they currently consume more freshwater per Joule of cooling in operation. For example, for natural gas combined cycle plants, cooling towers typically withdraw 150–760 gallons per megawatt-hour (gal/MWh) with a median of 250 gal/MWh and consume 47–300 gal/MWh (median 210 gal/MWh) of water, while once-through systems withdraw 7,200–21,000 gal/MWh (median 9,000 gal/MWh) and consume 20–230 gal/MWh (median 100 gal/MWh).<sup>105</sup> Replacing conventional cooling towers with air-cooled condensers could reduce water use by 80% for pulverized coal plants and 40% for pulverized coal plants with CCS.<sup>106</sup> However, challenges with dry cooling include higher capital costs, larger physical footprints, and reductions in power outputs on the hottest days—often when demand is highest. Opportunities for RDD&D in advanced dry cooling include early-stage breakthrough air-cooled heat exchanger technologies, which in small-scale applications have shown performance improvements of 12%–14%.<sup>107, 108</sup>

For wet-cooled systems, where evaporation accounts for 75% of cooling tower losses, water recovery systems have reduced evaporative consumption losses by 19%.<sup>109, 110</sup> The low concentration of total dissolved solids in the recovered water suggests that, with modifications, cooling towers could be freshwater sources. Other improvements, such as increasing the cycles of concentration in cooling towers from four to five, could decrease blowdown, or wasted water, by 25%.<sup>111</sup> Blowdown controls the concentration of dissolved solids in cooling towers; therefore, there are potential performance tradeoffs associated with reducing blowdown and water consumption and increasing dissolved solids concentration. Improved monitoring and control of blowdown can avoid potential risks to the system from scale or corrosion.

**Water treatment technologies for power applications:** The use of nontraditional waters could further reduce freshwater withdrawals and consumption. Cooling water needs for 81% of proposed plants could be met with water from publicly owned treatment works within a 10-mile radius, or 97% with a 25-mile radius.<sup>112</sup> For some areas of the United States, the costs for treatment of municipal wastewater effluent have been found to be within the range charged for alternative sources of cooling water, such as river water withdrawal with filtration and chemical conditioning and is below the national average rate for potable city water.<sup>113</sup> Advanced continuous nanofiltration technologies can further reduce consumption by as much as 40%.

### 4.3.2 Utilizing Technical Advances

The utilization of broad technical advances provide opportunity to increase the pacing of technology readiness, and accelerate the time required to scale up. The opportunities cover a range of disciplines that are addressed in greater depth in other sections of the QTR, but a handful are of notable interest in the development of clean power technologies. Advanced modeling and simulation enabled by HPC (Chapter 9) can provide the capability to reduce the time required to design and test new technologies by providing a virtual environment for exploring design trade-offs, minimizing the need to test multiple configurations and enabling the more efficient use of experimentation by validating theoretically derived codes. The development of advanced materials (see Chapter 6 and its Technology Assessments, and Chapter 9) holds the promise of reducing cost and improving performance of a range of technologies that are limited by the ability of structures to withstand the range of conditions to which they would be exposed. Modern manufacturing capabilities (Chapter 6) can drive down the cost to build clean generation capacity. Since life cycle costs of these technologies are less dependent upon fuel inputs, reducing the upfront capital cost to deployment could have a significant impact.

### 4.3.3 Leveraging Interfaces

The RDD&D environment of electrical power generation has a human interface on many levels. Not only is the end result to provide a consumer product, but throughout the RDD&D process there exists public-private collaboration and international coordination to enable this development.

#### Private/Public Roles

The traditional electric power generation industry has a long history of power supply planning and meeting evolving needs. Through an interaction of market and state regulation the private sector makes a selection of technologies based on local parameters, and more recently additional criteria and requirements, such as carbon constraints. The federal role of enabling and enhancing technology advancement includes assessing future security, economic, and environmental considerations, and ensuring power supply options are available to meet a broad set of societal goals. The role of public technology leadership lies in leveraging foundational science expertise to innovate, overcome development barriers in investment and public acceptance, and provide data and information in concert with policy and to achieve societal goals.

The scale and type of public investment evolves over the cycle of technology development. Early research may be heavily supported by public investments where concepts are far from commercial deployment. As technologies become more mature and closer to market the degree of public support is often reduced as private firms seek to reach commercialization and reap the benefits of widespread deployment. Technologies that require large-scale demonstrations before they will be commercially deployed, such as nuclear and CCS, may require the government to share in the cost of early demonstration that would otherwise be too risky for private firms to be expected to bear.

## International Partnerships and Markets

DOE participates in a variety of international agreements, including major multilateral agreements with the IEA and the Nuclear Energy Agency of the OECD, the International Renewable Energy Agency, and the International Atomic Energy Agency. Bilateral and multilateral agreements typically focus on promoting the safe deployment of clean energy technologies, as well as RDD&D considered pre-commercial or in markets lacking commercial drivers.

CCS has been an especially productive area for international RDD&D cooperation because market drivers for this technology do not exist in most countries, and CCS may be the most economical approach for dealing with a portion of the CO<sub>2</sub> emissions attributable to fossil fuels, which account for 80% of global energy. Recent CCS international initiatives include the International Test Center Network, which will facilitate the sharing of knowledge and expertise amongst the world's carbon capture test centers. In November 2014, President Obama and Chinese President Xi jointly announced that the United States and China will lead a major new carbon storage project based in China, and work together on a new EWR pilot project to produce fresh water from CO<sub>2</sub> injection into deep saline reservoirs.

Nuclear power technology development has similarly been shaped by international engagement. The first AP1000 reactors are being built in China, which is enabling U.S. projects to learn from these experiences. Collaborative RDD&D is part of the approach to developing new nuclear technologies as some key facilities and capabilities (such as fast neutron sources for fuel testing) may reside in only a handful of locations, thus requiring cooperation. The Generation IV International Forum has been established to facilitate collaborative RDD&D on advanced reactor concepts.

For the last twenty years, renewable technologies have been developing irrespective of national boundaries. Numerous bilateral and multilateral agreements have engaged research centers in Europe, Asia and North America to collectively develop fuel cells, wind, hydropower, solar, and geothermal capabilities. Marine RDD&D is a newer area where researchers have also worked across national boundaries to make recent advances. Scientific and engineering experts are working today on every continent to develop and deploy an appropriate portfolio of clean power technologies to match locally available resources.

## 4.4 Conclusion

This review provides an assessment of the status and challenges, and it also identifies opportunities for each technology to advance further or expand its respective contribution toward meeting overall system requirements and criteria. In addition, underlying common developments have potential to enable innovative breakthroughs, including the areas of materials, computing, data management, multivariable portfolio analysis for power generation, energy-water nexus, and energy storage. Both system and technology development opportunities are summarized in Table 4.5.

**Table 4.5** Opportunities in Clean Electric Power Technology Development

Opportunities in clean electric power technology development	
Carbon capture and storage	Second-generation pilot demonstrations of carbon capture and advanced energy systems for new build and existing plants and field tests addressing critical challenges such as pressure management, induced seismicity, and storage permanence
	Demonstration of CCS technologies on retrofit fossil fuel burning plants
	Application of CCS to natural gas and industrial plants, and need to address differences in CO <sub>2</sub> and O <sub>2</sub> concentrations and the effects on CCS technologies
	International partnerships continue opportunities for shared knowledge, expanded demonstration, and broad impact
Nuclear power	Light water reactors: Characterize reactor material aging, drive down costs of new construction, improve analysis tools to better characterize safety margins
	High temperature and fast reactors: Advanced materials/fuels, modeling and simulation with validation experiments to demonstrate performance
	Fuel cycle technology: Improved understanding of material degradation under extended storage of high-burnup fuels; assessing alternate repository geologies and long-term interaction effects with waste forms; research and testing of actinide-bearing fuels
	Hybrid systems: Dynamic modeling and demonstration of subsystem interfaces
Hydropower	Materials and turbine designs, modularization, technology-based footprint reduction
	Supporting research needed in hydrologic, ecological, environmental, hydrodynamic, hydromechanical, operations, and power system data collection, monitoring, modeling, and analysis
Wind power	HPC model development, verification, and validation of high-fidelity physics-based atmospheric and complex flow models to improve wind farm design and operation
	Effective grid integration, including high-resolution short-term resource forecasting
Biopower	Utility-scale biopower with CCS to improve power production efficiency and offer a cost-competitive GHG reduction alternative
	Use and integration of biogas processes
Solar (PV and CSP)	PV: Innovation that will enable low cost manufacturing in the United States
	CSP: Lower capital cost for large-scale deployment
	Systems integration: Integration with storage solutions and energy management systems
	Nonhardware soft cost: Solutions to streamline processes and drive down costs of permitting, interconnection, finance, and customer acquisition
Geothermal energy	Develop advanced remote resource characterization tools to identify geothermal opportunities without surface expression
	Purposeful control of subsurface fracturing and flow
	Improved and lower \$/MW subsurface access technologies
	Develop mineral recovery and hybrid systems to provide second stream of value
Fuel cells	Drive down costs through research into membrane processes and materials
	Focus on gas cleanup for increased fuel flexibility, advanced materials, hydrogen production, and manufacturing technology
	Modeling and simulation with technology validation to demonstrate performance
Marine hydrokinetic power	Next-generation component technology RDD&D designed specifically for the challenges of the marine environment, including advanced controls to tune devices to optimize energy extraction, compact high-torque low-speed generator technologies, and corrosion and biofouling resistant materials and coatings
	Development of open source, fully validated MHK modeling and simulation codes
	Collection of technology performance and cost data through device demonstrations

## Chapter 4: Advancing Clean Electric Power Technologies

# Technology Assessments

- 4A** Advanced Plant Technologies
- 4B** Biopower
- 4C** Carbon Dioxide Capture and Storage Value-Added Options
- 4D** Carbon Dioxide Capture for Natural Gas and Industrial Applications
- 4E** Carbon Dioxide Capture Technologies
- 4F** Carbon Dioxide Storage Technologies
- 4G** Crosscutting Technologies in Carbon Dioxide Capture and Storage
- 4H** Fast-spectrum Reactors
- 4I** Geothermal Power
- 4J** High Temperature Reactors
- 4K** Hybrid Nuclear-Renewable Energy Systems
- 4L** Hydropower
- 4M** Light Water Reactors
- 4N** Marine and Hydrokinetic Power
- 4O** Nuclear Fuel Cycles
- 4P** Solar Power
- 4Q** Stationary Fuel Cells
- 4R** Supercritical Carbon Dioxide Brayton Cycle
- 4S** Wind Power

[See online version.]

## Endnotes

- <sup>1</sup> *World Energy Outlook 2014*. Paris, France: International Energy Agency, 2014.
- <sup>2</sup> *Energy Technology Perspectives—2014*. Paris, France: International Energy Agency, 2014.
- <sup>3</sup> “Grid Energy Storage.” (2013). Washington, DC: U.S. Department of Energy, 2013. Available at: <http://etc/www.energy.gov/oe/downloads/grid-energy-storage-december-2013>.
- <sup>4</sup> *World Energy Outlook 2014*. Paris, France: International Energy Agency, 2014.
- <sup>5</sup> Energy Information Administration, U.S. Department of Energy, Annual Energy Outlook 2015, with Projections to 2040, DOE/EIA-0383(2015) April 2015. Available at: <http://www.eia.gov/forecasts/aeo/>.
- <sup>6</sup> *Energy Technology Perspectives 2014*. Paris, France: International Energy Agency, 2014.
- <sup>7</sup> “The Fifth Assessment Report of the Intergovernmental Panel on Climate Change.” Geneva, Switzerland: Intergovernmental Panel on Climate Change, 2014. Available at: <http://www.ipcc.ch/report/ar5/index.shtml>.
- <sup>8</sup> Gerdes, K.; Stevens, R.; Fout, T.; Fisher, J.; Hacket, G.; Sheldon, J. “Current and Future Power Generation Technologies: Pathways to Reducing the Cost of Carbon Capture for Coal-fueled Power Plants.” *Energy Procedia* (63), 2014; pp. 7541–7557. Available at: <http://www.sciencedirect.com/science/article/pii/S1876610214026058>.
- <sup>9</sup> “Global Status of CCS 2014.” Melbourne, Australia: Global CCS Institute, 2014. Available at: <http://www.globalccsinstitute.com/in-focus/global-status-ccs-2014>.
- <sup>10</sup> “MIT CCS Project Database: Plant Barry Fact Sheet.” Carbon Capture and Sequestration Technologies at MIT, 2015. Available at: [http://sequestration.mit.edu/tools/projects/plant\\_barry.html](http://sequestration.mit.edu/tools/projects/plant_barry.html).
- <sup>11</sup> Gerdes, K.; Stevens, R.; Fout, T.; Fisher, J.; Hacket, G.; Sheldon, J. (2014). “Current and Future Power Generation Technologies: Pathways to Reducing the Cost of Carbon Capture for Coal-fueled Power Plants.” *Energy Procedia* (63), 2014; pp. 7541–7557.
- <sup>12</sup> “Basin Oriented Strategies for CO<sub>2</sub> Enhanced Oil Recovery: Onshore Gulf Coast.” ARI, 2005. Available at: [http://www.netl.doe.gov/kmd/cds/disk22/F-ARI%20Basin%20Oriented%20Strategies%20for%20CO2/gulfcoast\\_report.pdf](http://www.netl.doe.gov/kmd/cds/disk22/F-ARI%20Basin%20Oriented%20Strategies%20for%20CO2/gulfcoast_report.pdf).
- <sup>13</sup> “U.S. Oil Production Potential from Accelerated Deployment of Carbon Capture and Storage.” Arlington, VA: Advanced Resources International, 2010. Available at: <http://www.adv-res.com/pdf/v4ARI%20CCS-CO2-EOR%20whitepaper%20FINAL%204-2-10.pdf>.
- <sup>14</sup> Ibid. IEA, “World Energy Outlook—2013.” Available at: <http://www.worldenergyoutlook.org/>.
- <sup>15</sup> “DOE/NETL’s Carbon Capture R&D Program for Existing Coal-Fired Power Plants.” DOE/NETL- 2009/1356, 2009. Available at: <http://www.netl.doe.gov/research/energy-analysis/publications/details?pub=0a636ca9-cab5-43a7-8e12-31cc33ba919c>.
- <sup>16</sup> Ciferno, J. P.; Fout, T. E.; Jones, A. P.; Murphy, J. T. “Capturing Carbon from Existing Coal-Fired Power Plants.” DOE/NETL-2009/1356. Pittsburgh, PA: U.S. Department of Energy/National Energy Technology Laboratory, 2009. Available at: <http://www.netl.doe.gov/File%20Library/Research/Energy%20Analysis/Publications/DOE-NETL-2009-1356-CarbCaptRDProgExistCFPP-Overview0209.pdf>.
- <sup>17</sup> “Inventory of U.S. Greenhouse Gas Emissions and Sinks: 1990–2013.” Washington, DC: U.S. Environmental Protection Agency, 2015. Available at: <http://www.epa.gov/climatechange/ghgemissions/usinventoryreport.html>.
- <sup>18</sup> “Technology Roadmap: Carbon Capture and Storage in Industrial Applications.” Paris, France: International Energy Agency, 2011. Available at: [http://www.iea.org/publications/freepublications/publication/ccs\\_industry.pdf](http://www.iea.org/publications/freepublications/publication/ccs_industry.pdf).
- <sup>19</sup> “Re-energizing Global Momentum for CCS and Identifying Key Actions Needed for CCS Deployment.” Carbon Sequestration Leadership Forum Ministerial Meeting Communique. Washington, DC, 2013. Available at: <http://www.cslforum.org/publications/documents/Washington2013/MinisterialCommunique-Washington1113.pdf>.
- <sup>20</sup> “U.S.-China Climate Change Working Group Fact Sheet.” U.S. Department of State, 2013. Available at: <http://www.state.gov/r/pa/prs/ps/2013/07/211768.htm>.
- <sup>21</sup> “About the CSLE.” Carbon Sequestration Leadership Forum, 2015. Available at: <http://www.cslforum.org/aboutus/index.html>.
- <sup>22</sup> “Monthly Energy Review.” DOE/EIA-0035. Washington, DC: U.S. Energy Information Administration, September 2014; Table 7.2a. Available at: <http://www.eia.gov/totalenergy/data/monthly/archive/00351409.pdf>.
- <sup>23</sup> Ibid. Table 8.1.
- <sup>24</sup> “On-Site Storage of Nuclear Waste.” Nuclear Energy Institute, 2015. Available at: <http://www.nei.org/Knowledge-Center/Nuclear-Statistics/On-Site-Storage-of-Nuclear-Waste>.
- <sup>25</sup> *World Energy Outlook 2014*. Paris, France: International Energy Agency, 2014.
- <sup>26</sup> “Nuclear Energy Research and Development Roadmap: Report to Congress.” Washington, DC: U.S. Department of Energy, 2010. Available at: [http://energy.gov/sites/prod/files/NuclearEnergy\\_Roadmap\\_Final.pdf](http://energy.gov/sites/prod/files/NuclearEnergy_Roadmap_Final.pdf).
- <sup>27</sup> “Power Reactor Information System.” International Atomic Energy Agency, 2015. Available at: <https://www.iaea.org/pris/>.
- <sup>28</sup> “Modifying the Risk-Informed Regulatory Guidance for New Reactors.” SECY-10-0121, Rockville, MD: Nuclear Regulatory Commission, 2010. Available at: <http://www.nrc.gov/reading-rm/doc-collections/commission/secys/2010/secy2010-0121/2010-0121scypdf>.

- <sup>29</sup> “Monthly Energy Review.” DOE/EIA-0035. Washington, DC: U.S. Energy Information Administration, January 2015. Table 8.1. Available at: <http://www.eia.gov/totalenergy/data/monthly/archive/00351501.pdf>.
- <sup>30</sup> U.S. Nuclear Regulatory Commission. An Additional 18 Units Have Applications Under Review for License Renewals and the Remaining Five Are Expected to Apply Prior to 2019. Available at: <http://www.nrc.gov/reactors/operating/licensing/renewal/applications.html>.
- <sup>31</sup> General Electric Reported That Its ESBWR Reactor Eliminated 25% of the Pumps, Valves, and Motors of Its Previous Version. Available at: <https://nuclear.gpower.com/build-a-plant/products/nuclear-power-plants-overview/esbwr.html>.
- <sup>32</sup> “Ultra Safe Nuclear.” HTGR Economic/Business Analysis and Trade Studies. USNC-NIA-G00001, 2013.
- <sup>33</sup> The radiotoxicity of used nuclear fuel exceeds that of the original uranium ore for about 300,000 years. Converting long-lived transuranic elements into shorter-lived fission products as part of the process of running a fast reactor results in a waste that reaches the original level of radiotoxicity in just several hundred years. “Advanced Fuel Cycle Initiative: Objectives, Approach, and Technology Summary, Report to Congress.” Washington, DC: U.S. Department of Energy, Office of Nuclear Energy, Science, and Technology, 2005. Available at: [http://web.missouri.edu/~suppesg/book/AFCI\\_RptCong\\_ObjApp%5BTechSummMay2005.pdf](http://web.missouri.edu/~suppesg/book/AFCI_RptCong_ObjApp%5BTechSummMay2005.pdf).
- <sup>34</sup> Additional reactor concepts have been proposed that could enable transmutation without operating completely in a fast spectrum. These approaches tend to rely on fuels dissolved in molten salts that allow for a window of transmutation in the fast spectrum before a neutron moderator has the opportunity to slow the released neutrons into a thermal spectrum that would help to maintain a chain reaction.
- <sup>35</sup> Wigeland, R.; Taiwo, T.; Ludwig, H.; Todosow, M.; Halsey, W.; Gehin, J.; Jubin, R.; Buelt, J.; Sockinger, S.; Jenni, K.; Oakley, B. “Nuclear Fuel Cycle Evaluation and Screening—Final Report.” INL/EXT-14-31465. Idaho Falls, IS: Idaho National Laboratory, 2014. Available at: [https://inlportal.inl.gov/portal/server.pt/community/nuclear\\_science\\_and\\_technology/337/nuclear\\_fuel\\_cycle\\_evaluation\\_and\\_screening\\_final\\_report/11118](https://inlportal.inl.gov/portal/server.pt/community/nuclear_science_and_technology/337/nuclear_fuel_cycle_evaluation_and_screening_final_report/11118).
- <sup>36</sup> Initial work in Japan had indicated that uranium could be recovered from seawater at a cost of \$1,000/kg, but recent research by DOE has demonstrated feasibility at about \$600/kg with designs of driving costs much lower until closer to the upper range of spot market prices seen over the last decade, around \$200–\$300/kg. Schneider, E. A.; Lindner H. D. “Energy Balance of Uranium Recovery from Seawater.” *Science & Global Security* (21:2), 2013; pp. 134-163.
- <sup>37</sup> Following the recommendations of the “Blue Ribbon Commission of America’s Nuclear Future,” the administration issued the “Strategy for the Management and Disposal of Used Nuclear Fuel and High Level Radioactive Waste.” “Blue Ribbon Commission of America’s Nuclear Future—Report to the Secretary of Energy.” Washington, DC: U.S. Department of Energy, 2012. Available at: <http://energy.gov/ne/downloads/blue-ribbon-commission-americas-nuclear-future-report-secretary-energy>.
- <sup>38</sup> “Annual Energy Review.” EIA, OE/EIA-0384, Washington, DC: Energy Information Administration, 2011. Available at: <http://www.eia.gov/totalenergy/data/annual/pdf/aer.pdf>. See also “Electric Power Monthly.” Washington, DC: Energy Information Administration, 2014. Available at: [http://www.eia.gov/electricity/monthly/current\\_year/march2014.pdf](http://www.eia.gov/electricity/monthly/current_year/march2014.pdf).
- <sup>39</sup> “Monthly Energy Review.” DOE/EIA-0035. Washington, DC: Energy Information Administration, March 2015. Available at: <http://www.eia.gov/totalenergy/data/monthly/archive/00351503.pdf>.
- <sup>40</sup> For more information see “Quantifying the Value of Hydropower in the Electric Grid: Final Report.” DE-EE0002666. Washington, DC: Electric Power Research Institute, 2013. Available at: [http://www1.eere.energy.gov/wind/pdfs/epri\\_value\\_hydropower\\_electric\\_grid.pdf](http://www1.eere.energy.gov/wind/pdfs/epri_value_hydropower_electric_grid.pdf).
- <sup>41</sup> Tagliaferre, L. “Renewing Interest in Hydropower.” 2008. Available at: <http://www.buildings.com/article-details/articleid/6276/title/renewing-interest-in-hydropower.aspx>.
- <sup>42</sup> “Monthly Energy Review.” DOE/EIA-0035(2015/06). Washington, DC: Energy Information Administration, June 2015. Table 7.2b. Available at: <http://www.eia.gov/totalenergy/data/monthly/archive/00351506.pdf>.
- <sup>43</sup> Kao, S. C.; McManamay, R. M.; Stewart, K. M.; Samu, N. M.; Hadjerioua, B.; DeNeale, S. T.; Yeasmin, D.; Pasha, M. F. K.; Oubeidillah, A.; Smith, B. T. “New Stream-reach Development: A Comprehensive Assessment of Hydropower Energy Potential in the United States.” GPO DOE/EE-1063. Washington, DC: ORNL/DOE, 2014. Available at: [http://nhaap.ornl.gov/sites/default/files/ORNL\\_NSD\\_FY14\\_Final\\_Report.pdf](http://nhaap.ornl.gov/sites/default/files/ORNL_NSD_FY14_Final_Report.pdf).
- <sup>44</sup> Hadjerioua, B.; Wei, Y.; Kao, S. C. “An Assessment of Energy Potential at Non-Powered Dams in the U.S.” DE-AC05-00OR22725. Oak Ridge, TN: Oak Ridge National Laboratory, 2012. Available at: [http://www1.eere.energy.gov/water/pdfs/npd\\_report.pdf](http://www1.eere.energy.gov/water/pdfs/npd_report.pdf).
- <sup>45</sup> “Monthly Energy Review.” DOE/EIA-0035. Washington, DC: Energy Information Agency, March 2015. Available at: <http://www.eia.gov/totalenergy/data/monthly/archive/00351503.pdf>.
- <sup>46</sup> “U.S. Wind Industry Fourth Quarter 2014 Market Report.” Washington, DC: American Wind Energy Association, 2015. Available at: <http://www.awea.org/Resources/Content.aspx?ItemNumber=7150>.
- <sup>47</sup> Wiser, R.; Bolinger, M.; et al. “2014 Wind Technologies Market Report.” Lawrence Berkeley National Laboratory for the U.S. Department of Energy, Office of Energy Efficiency and Renewable Energy, August 2015. Available at: <http://energy.gov/eere/wind/downloads/2014-wind-technologies-market-report>.
- <sup>48</sup> “Wind Vision: A New Era for Wind Power in the United States.” DOE/GO-102015-4557: U.S. Department of Energy, 2015. Available at: [http://www.energy.gov/sites/prod/files/WindVision\\_Report\\_final.pdf](http://www.energy.gov/sites/prod/files/WindVision_Report_final.pdf).
- <sup>49</sup> “U.S. Wind Industry Fourth Quarter 2014 Market Report.” Washington, DC: American Wind Energy Association, 2015. Available at: <http://www.awea.org/Resources/Content.aspx?ItemNumber=7150>.
- <sup>50</sup> “Wind Vision Scenario Framework.” Washington, DC: U.S. Department of Energy, 2015. Available at: <http://www.energy.gov/eere/wind/maps/wind-vision>.



- <sup>51</sup> “U.S. Offshore Wind: Advanced Technology Demonstration Projects.” U.S. Department of Energy Wind Program Office, 2012. Available at: [http://www1.eere.energy.gov/wind/financial\\_opps\\_detail.html?sol\\_id=473](http://www1.eere.energy.gov/wind/financial_opps_detail.html?sol_id=473).
- <sup>52</sup> “Fact Sheet: Renewable Energy on the Outer Continental Shelf.” Bureau of Ocean Energy Management, 2015. Accessed March 5, 2015: <http://www.boem.gov/BOEM-Overview-Renewable-Energy/>.
- <sup>53</sup> “Wind Vision: A New Era for Wind Power in the United States.” DOE/GO-102015-4557: U.S. Department of Energy, 2015. Available at: [http://www.energy.gov/sites/prod/files/WindVision\\_Report\\_final.pdf](http://www.energy.gov/sites/prod/files/WindVision_Report_final.pdf).
- <sup>54</sup> Sanchez, D.; Nelson, J.; Johnson, J.; Mileva, A.; Kammen, D. “Biomass Enables the Transition to a Carbon-Negative Power System Across Western North America.” *Nature Climate Change* (5), 2015; pp. 230-234.
- <sup>55</sup> “Potential for Biomass and Carbon Dioxide Capture and Storage.” Stoke Orchard, UK: International Energy Agency Greenhouse Gas R&D Programme, 2011. Available at: [http://ieaghg.org/docs/General\\_Docs/Reports/2011-06.pdf](http://ieaghg.org/docs/General_Docs/Reports/2011-06.pdf).
- <sup>56</sup> “NREL Biopower Atlas, 2014.” National Renewable Energy Laboratory, 2014. Accessed November 17, 2014: <http://maps.nrel.gov/biopower>.
- <sup>57</sup> Boardman, R.; Cafferty, K.; Nichol, C.; Searcy, E.; Westover, T.; Wood, R.; Bearden, M.; Cabe, J.; Drennan, C.; Jones, S.; Male, J.; Muntean, G.; Snowden-Swan, L.; Widder, S. “Logistics, Costs, and GHG Impacts of Utility-Scale Cofiring with 20% Biomass.” Technical Report. INL/EXT-12-25252 and PNNL-23492, 2013. Available at: [http://www.pnnl.gov/main/publications/external/technical\\_reports/PNNL-23492.pdf](http://www.pnnl.gov/main/publications/external/technical_reports/PNNL-23492.pdf).
- <sup>58</sup> Bain, R. L.; Amos, W. A.; Downing, M.; Perlack, R. L. “Biopower Technical Assessment: State of the Industry and Technology.” Technical Report. NREL/TP-510-33123, Golden, CO: National Renewable Energy Laboratory, 2003. Available at: <http://www.nrel.gov/docs/fy03osti/33123.pdf>.
- <sup>59</sup> The EIA figures previously cited only include utility scale solar, the 2% of capacity 20 GW of deployed solar, and 1% of generation figures cited in this section represents the utility and distributed sources of solar energy. See, for example, GTM Research and SEIA. *U.S. Solar Market Insight 2014 Year-in-Review*. Boston, MA, 2015.
- <sup>60</sup> Friedman, B.; Ardani, K.; Feldman, D.; Citron, R.; Margolis, R.; Zuboy, J. “Benchmarking Non-Hardware Balance-of-System (Soft) Costs for U.S. Photovoltaic Systems, Using a Bottom-Up Approach and Installer Survey. Second Edition.” NREL/TP-6A20-60412. Golden, CO: National Renewable Energy Laboratory, 2013. Available at: <http://www.nrel.gov/docs/fy14osti/60412.pdf>.
- <sup>61</sup> Feldman, D.; Barbose, G.; Margolis, R.; Darghouth, N.; James, T.; Weaver, S.; Goodrich, A.; Wiser, R. “Photovoltaic System Pricing Trends: Historical, Recent, and Near-Term Projections.” 2014 Edition, 2014. Available at: <http://www.nrel.gov/docs/fy14osti/62558.pdf>.
- <sup>62</sup> “National Solar Jobs Census, 2014.” Washington, DC: The Solar Foundation, 2015. Available at: [http://www.thesolarfoundation.org/wp-content/uploads/2015/01/TSF-National-Census-2014-Report\\_web.pdf](http://www.thesolarfoundation.org/wp-content/uploads/2015/01/TSF-National-Census-2014-Report_web.pdf).
- <sup>63</sup> Feldman, D.; Barbose, G.; Margolis, R.; Darghouth, N.; James, T.; Weaver, S.; Goodrich, A.; Wiser, R. “Photovoltaic System Pricing Trends: Historical, Recent, and Near-Term Projections.” 2014 Edition, 2014. Available at: <http://www.nrel.gov/docs/fy14osti/62558.pdf>.
- <sup>64</sup> Friedman, B.; Ardani, K.; Feldman, D.; Citron, R.; Margolis, R.; Zuboy, J. (2013). “Benchmarking Non-Hardware Balance-of-System (Soft) Costs for U.S. Photovoltaic Systems, Using a Bottom-Up Approach and Installer Survey. Second Edition.” NREL/TP-6A20-60412. Golden, CO: National Renewable Energy Laboratory, 2013. Available at: <http://www.nrel.gov/docs/fy14osti/60412.pdf>.
- <sup>65</sup> “SunShot Vision Study.” Washington, DC: U.S. Department of Energy, 2012. Accessed December 2014: Available at: <http://energy.gov/eere/sunshot/sunshot-vision-study>.
- <sup>66</sup> Ibid.
- <sup>67</sup> Ibid.
- <sup>68</sup> Ibid.
- <sup>69</sup> Friedman, B.; Ardani, K.; Feldman, D.; Citron, R.; Margolis, R.; Zuboy, J. (2013). “Benchmarking Non-Hardware Balance-of-System (Soft) Costs for U.S. Photovoltaic Systems, Using a Bottom-Up Approach and Installer Survey. Second Edition.” NREL/TP-6A20-60412. Golden, CO: National Renewable Energy Laboratory, 2013. Available at: <http://www.nrel.gov/docs/fy14osti/60412.pdf>.
- <sup>70</sup> “Annual Energy Outlook 2014.” DOE/EIA-0383. Washington, DC. U.S. Energy Information Administration, 2014. Available at: <http://www.eia.gov/forecasts/archive/aeo14/>.
- <sup>71</sup> Matek, B.; Gawell, K. “Report on the State of Geothermal Energy in California.” Washington, DC: Geothermal Energy Association, 2014. Available at: <http://geo-energy.org/events/California%20Status%20Report%20February%202014%20Final.pdf>.
- <sup>72</sup> “Enhanced Geothermal Systems.” U.S. Department of Energy Geothermal Technologies Office, 2015. Available at: <http://energy.gov/eere/geothermal/enhanced-geothermal-systems-0>.
- <sup>73</sup> Williams, C. F.; Reed, M. J.; Mariner, R. H.; DeAngelo, J.; Galanis, S. P., Jr. “Assessment of Moderate- and High-Temperature Geothermal Resources of the United States.” Geological Survey Fact Sheet 2008-3082. Washington, DC: U.S. Geological Survey, 2008. Available at: <http://pubs.usgs.gov/fs/2008/3082/>.
- <sup>74</sup> Ibid.
- <sup>75</sup> “Enhanced Geothermal Systems.” JSR-13-320. McLean, VA: MITRE Corporation, 2013. Available at: <http://www1.eere.energy.gov/geothermal/pdfs/jason.final.pdf>.
- <sup>76</sup> Ziagos, J. P.; Phillips, B. R.; Boyd, L.; Jelacic, A.; Stillman, G.; Hass, E. (2013). “A Technology Roadmap for Strategic Development of Enhanced Geothermal Systems.” Proceedings of the 38th Workshop on Geothermal Reservoir Engineering, Stanford, CA. February 11–12, 2013; pp. 11-13. Available at: [https://www1.eere.energy.gov/geothermal/pdfs/stanford\\_egs\\_technical\\_roadmap2013.pdf](https://www1.eere.energy.gov/geothermal/pdfs/stanford_egs_technical_roadmap2013.pdf).

- <sup>77</sup> “Subsurface Characterization Letter Report.” JSR-14-Task-013. McLean, VA: Mitre Corporation, McLean Virginia, 2014. Available at: [http://www.energy.gov/sites/prod/files/2014/09/f18/2014%20SubTER%20JASON%20Report\\_1.pdf](http://www.energy.gov/sites/prod/files/2014/09/f18/2014%20SubTER%20JASON%20Report_1.pdf).
- <sup>78</sup> “Enhanced Geothermal Systems Demonstration Projects.” U.S. Department of Energy Geothermal Technologies Program. Available at: <http://energy.gov/eere/geothermal/enhanced-geothermal-systems-demonstration-projects>.
- <sup>79</sup> “A History of Geothermal Energy Research and Development in the United States: Reservoir Engineering 1976–2006.” Washington, DC: U.S. Department of Energy Geothermal Technologies Program, 2006. Available at: [http://energy.gov/sites/prod/files/2014/02/f7/geothermal\\_history\\_3\\_engineering.pdf](http://energy.gov/sites/prod/files/2014/02/f7/geothermal_history_3_engineering.pdf).
- <sup>80</sup> Scales include small DG (<20–30 kW, commercial/industrial [0.2 to a few MW], utility scale [10s–100s MW]).
- <sup>81</sup> PEMFC and PAFC operate at lower temperatures than MCFC and SOFC (see Chapter 4Q. “Stationary Fuel Cells” Technology Assessment).
- <sup>82</sup> Industry investment in advanced manufacturing processes can potentially reduce costs but is more likely in a high-demand situation. In the early commercialization phase, low demand is a barrier across fuel cell types.
- <sup>83</sup> Wei, M.; McKone, T. “A Total Cost of Ownership Model for Design and Manufacturing Optimization of Fuel Cells in Stationary and Emerging Market Applications.” Presentation at the 2014 DOE Hydrogen and Fuel Cells Program Annual Merit Review, 2014. Available at: [http://www.hydrogen.energy.gov/pdfs/review14/fc098\\_wei\\_2014\\_o.pdf](http://www.hydrogen.energy.gov/pdfs/review14/fc098_wei_2014_o.pdf). Confidential information from a major U.S. fuel cell company was provided to the Fuel Cell Technologies Office in 2014.
- <sup>84</sup> SOFCs can achieve this efficiency. MCFCs can achieve this efficiency only in hybrid cycles that capture waste heat to produce steam to drive a turbine to produce electricity. While modern NGCC plants have LHV efficiency in the high 50 percentile, they do not have an outlet for their waste heat and are also penalized with nearly 7% loss associated with transmission and distribution.
- <sup>85</sup> “World’s Largest Fuel Cell Plant Opens in South Korea.” Power, February 2014. Available at: <http://www.powermag.com/worlds-largest-fuel-cell-plant-opens-in-south-korea/>.
- <sup>86</sup> “Levelized Costs of CHP and PV.” Record #14003. Washington, DC: U.S. Department of Energy Offices of Solar Energy Technologies and Fuel Cell Technologies, 2014. Available at: [http://www.hydrogen.energy.gov/pdfs/14003\\_lcoe\\_from\\_chp\\_and\\_pv.pdf](http://www.hydrogen.energy.gov/pdfs/14003_lcoe_from_chp_and_pv.pdf).
- <sup>87</sup> “Medium-scale CHP Fuel Cell System Targets.” Record #11014. Washington, DC: U.S. Department of Energy Hydrogen and Fuel Cells Program, 2012. Available at: [http://www.hydrogen.energy.gov/pdfs/11014\\_medium\\_scale\\_chp\\_target.pdf](http://www.hydrogen.energy.gov/pdfs/11014_medium_scale_chp_target.pdf).
- <sup>88</sup> Ibid.
- <sup>89</sup> Vora, S. D. “Office of Fossil Energy’s Solid Oxide Fuel Cell Program Overview.” 15th Annual SECA Workshop, July 22–23, 2014. Pittsburgh, PA: National Energy Technology Laboratory, July 2014. Available at: <http://www.netl.doe.gov/File%20Library/Events/2014/2014%20SECA%20workshop/Shailesh-Vora.pdf>.
- <sup>90</sup> “Oceans and Coasts.” National Oceanic and Atmospheric Administration, 2015. Accessed February 11, 2015: [http://www.education.noaa.gov/Ocean\\_and\\_Coasts/](http://www.education.noaa.gov/Ocean_and_Coasts/).
- <sup>91</sup> Technical resource potential refers to the portion of a theoretical resource (annual average amount of physical energy that is hypothetically available) that can be captured by using a specific technology.
- <sup>92</sup> Jacobson, P.; Hagerman, G.; Scott, G. “Mapping and Assessment of the United States Ocean Wave Energy Resource.” Report Number 1024637. Palo Alto, CA: Electric Power Research Institute, 2011. Available at: <http://www1.eere.energy.gov/water/pdfs/mappingandassessment.pdf>.
- <sup>93</sup> Haas, K.; Fritz, H.; French, S.; Neary, V. “Assessment of Energy Production Potential from Ocean Currents Along the United States Coastlines.” DE-EE0002661. Atlanta, GA: Georgia Tech Research Corporation, 2013. Available at: [http://energy.gov/sites/prod/files/2013/12/f5/energy\\_production\\_ocean\\_currents\\_us\\_0.pdf](http://energy.gov/sites/prod/files/2013/12/f5/energy_production_ocean_currents_us_0.pdf).
- <sup>94</sup> Ibid.
- <sup>95</sup> Ravens, T.; Cunningham, K.; Scott, G. “Assessment and Mapping of the Riverine Hydrokinetic Resource in the Continental United States.” Report Number 1026880. Palo Alto, CA: Electrical Power Research Institute, 2012. Available at: [http://www1.eere.energy.gov/water/pdfs/riverine\\_hydrokinetic\\_resource\\_assessment\\_and\\_mapping.pdf](http://www1.eere.energy.gov/water/pdfs/riverine_hydrokinetic_resource_assessment_and_mapping.pdf).
- <sup>96</sup> Based on an average annual U.S. residential electricity consumption of 10,837 kWh in 2012 (EIA).
- <sup>97</sup> Li, G.; Weiss, G.; Mueller, M.; Townley, S.; Belmont, M. “Wave Energy Converter Control by Wave Prediction and Dynamic Programming.” *Renewable Energy* (48:0), 2012; pp. 392–403. Available at: [http://www.eng.tau.ac.il/~gweiss/art101\\_RenEnergy.pdf](http://www.eng.tau.ac.il/~gweiss/art101_RenEnergy.pdf).
- <sup>98</sup> FERC, Licensed Marine and Hydrokinetic Projects; FERC, Issued Hydrokinetic Projects Preliminary Permits.
- <sup>99</sup> “MeyGen on Pace for 2016 Launch.” reNEWS. Accessed March 4, 2015: <http://renews.biz/84853/meygen-on-pace-for-2016-launch/>.
- <sup>100</sup> Availability refers to the proportion of time a system is in a functioning condition.
- <sup>101</sup> “Summary of Estimated Water Use in the United States in 2010.” Fact Sheet 2014-3109. Washington, DC: U.S. Geological Survey, 2014. Available at: <http://pubs.usgs.gov/fs/2014/3109/pdf/fs2014-3109.pdf>.
- <sup>102</sup> “The Water-Energy Nexus: Challenges and Opportunities.” Washington, DC: U.S. Department of Energy, 2014. Available at: <http://energy.gov/downloads/water-energy-nexus-challenges-and-opportunities>.
- <sup>103</sup> Ibid.

- <sup>104</sup> Silaen, A.; Wu, B.; Fu, D.; Zhou, C.; Yazawa, K.; Shakouri, A. "Numerical Model of Thermoelectric Topping Cycle of Coal Fired Power Plant." ASME 2013 4th Micro/Nanoscale Heat & Mass Transfer International Conference Proceedings. December 11–14, 2013. Hong Kong.
- <sup>105</sup> Meldrum, J.; Nettles-Anderson, S.; Heath, G.; Macknick, J. "Life Cycle Water Use for Electricity Generation: A Review and Harmonization of Literature." *Environ. Res. Lett.* (8), 2013. Available at: [http://iopscience.iop.org/1748-9326/8/1/015031/pdf/1748-9326\\_8\\_1\\_015031.pdf](http://iopscience.iop.org/1748-9326/8/1/015031/pdf/1748-9326_8_1_015031.pdf).
- <sup>106</sup> Zhai, H.; Rubin, E. S.; Versteeg, P. L. "Water Use at Pulverized Coal Power Plants with Postcombustion Carbon Capture and Storage." *Environ. Sci. Technol.* (45), 2011; pp. 2479-2485.
- <sup>107</sup> Johnson, T. A.; Staats, W. L.; Leick, M. T.; Zimmerman, M.; Radermacher, R.; Nasuta, D.; Martin, C.; Kalinowski, P.; Hoffman, W. "Development and Testing of an Integrated Sandia Cooler Thermoelectric Device (SCTD)." SAND2014-20146. Albuquerque, NM: Sandia National Laboratories, 2014. Available at: <http://prod.sandia.gov/techlib/access-control.cgi/2014/1420146.pdf>.
- <sup>108</sup> "Department of Energy Announces 23 New Projects to Improve Efficiency and Create New Technology Pathways for Energy Innovation." Advanced Research Projects Agency—Energy, 2015. Available at: <http://arpa-e.energy.gov/?q=news-item/department-energy-announces-23-new-projects-improve-efficiency-and-create-new-technology>.
- <sup>109</sup> Zhai, H.; Rubin, E.S. "Carbon Capture Effects on Water Use at Pulverized Coal Power Plants." *Energy Procedia* (4), 2011; pp. 2238-2244.
- <sup>110</sup> Mortensen, K. "Use of Air2Air™ Technology to Recover Fresh-Water from the Normal Evaporative Cooling Loss at Coal-Based Thermoelectric Power Plants." Overland Park, KS: SPX Cooling Technologies, 2009. Available at: [https://www.netl.doe.gov/File%20Library/Research/Coal/ewr/water/NT42725\\_SPX-Cooling\\_Final-Report.pdf](https://www.netl.doe.gov/File%20Library/Research/Coal/ewr/water/NT42725_SPX-Cooling_Final-Report.pdf).
- <sup>111</sup> Zhai, H.; Rubin, E. S. "Carbon Capture Effects on Water Use at Pulverized Coal Power Plants." *Energy Procedia* (4), 2011; pp. 2238-2244.
- <sup>112</sup> Vidic, R. D.; Dzombak, D. A.; Hsieh, M.; Li, H.; Chien, S.; Feng, Y.; Chowdhury, I.; Monnell, J. D. "Reuse of Treated Internal or External Wastewaters in the Cooling Systems of Coal-Based Thermoelectric Power Plants." Pittsburgh, PA: University of Pittsburgh, 2009. Available at: <http://www.netl.doe.gov/File%20Library/Research/Coal/ewr/water/42722FSRFG063009.pdf>.
- <sup>113</sup> Theregowda, R.; Hsieh, M.; Walker, M. E.; Landis, A. E.; Abbasian, J.; Vidic, R.; Dzombak, D. A. "Life Cycle Costs to Treat Secondary Municipal Wastewater for Reuse in Cooling Systems." *Journal of Water Reuse and Desalination* (3:3), 2013; pp. 224-238. Available at: <http://www.iwaponline.com/jwrd/003/jwrd0030224.htm>.



## Issues and RDD&D Opportunities

The buildings sector accounts for about 76% of electricity use and 40% of all U. S. primary energy use and associated greenhouse gas (GHG) emissions, making it essential to reduce energy consumption in buildings in order to meet national energy and environmental challenges (Chapter 1) and to reduce costs to building owners and tenants. Opportunities for improved efficiency are enormous. By 2030, building energy use could be cut more than 20% using technologies known to be cost effective today and by more than 35% if research goals are met. Much higher savings are technically possible.

Building efficiency must be considered as improving the performance of a complex system designed to provide occupants with a comfortable, safe, and attractive living and work environment. This requires superior architecture and engineering designs, quality construction practices, and intelligent operation of the structures. Increasingly, operations will include integration with sophisticated electric utility grids.

The major areas of energy consumption in buildings are heating, ventilation, and air conditioning—35% of total building energy; lighting—11%; major appliances (water heating, refrigerators and freezers, dryers)—18% with the remaining 36% in miscellaneous areas including electronics. In each case there are opportunities both for improving the performance of system components (e.g., improving the efficiency of lighting devices) and improving the way they are controlled as a part of integrated building systems (e.g., sensors that adjust light levels to occupancy and daylight).

Key research opportunities include the following:

- High-efficiency heat pumps that reduce or eliminate the use of refrigerants that can lead to GHG emissions
- Thin insulating materials
- Windows and building surfaces with tunable optical properties
- High efficiency lighting devices including improved green light-emitting diodes, phosphors, and quantum dots
- Improved software for optimizing building design and operation
- Low cost, easy to install, energy harvesting sensors and controls
- Interoperable building communication systems and optimized control strategies
- Decision science issues affecting purchasing and operating choices

# 5

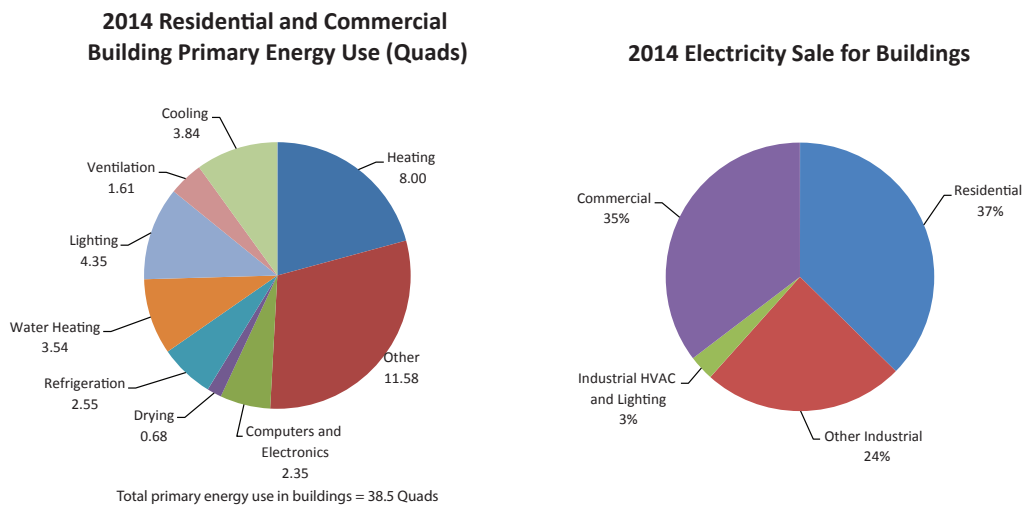
## Increasing Efficiency of Building Systems and Technologies

### 5.1 Introduction

More than 76% of all U.S. electricity use and more than 40% of all U.S. energy use and associated greenhouse gas (GHG) emissions are used to provide comfortable, well-lit, residential and commercial buildings—and to provide space conditioning and lighting for industrial buildings. Successfully meeting priority technology goals for performance and cost will make it possible to significantly reduce this energy use by 2030 in spite of forecasted growth in population and business activity.

Figure 5.1 shows U.S. building energy use in 2014.<sup>1</sup> Space conditioning, water heating, and lighting represent well over half of the total, including energy used in outdoor lighting and cooling most data centers.

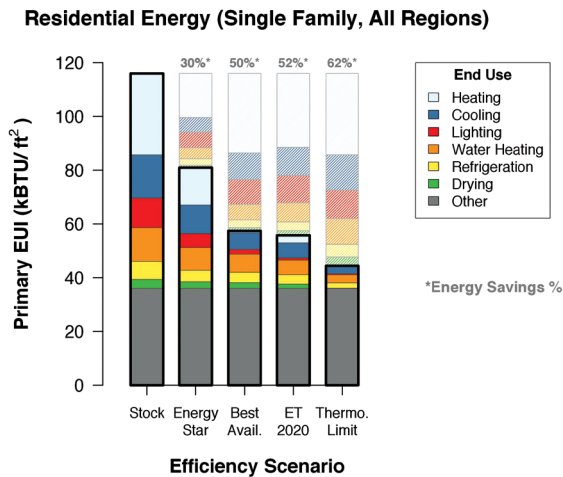
**Figure 5.1** Buildings Use More Than 38% of all U.S. Energy and 76% of U.S. Electricity<sup>1</sup>



Key: **Quad** = quadrillion Btu; **Btu** = British thermal unit

The building sector's share of electricity use has grown dramatically in the past five decades from 25% of U.S. annual electricity consumption in the 1950s to 40% in the early 1970s to more than 76% by 2012.<sup>2</sup> Absent significant increases in building efficiency, total U.S. electricity demand would have grown much more rapidly than it did during this period.

**Figure 5.2** Use of ENERGY STAR® technologies would reduce residential energy consumption 30%, best available technology 50%, goals of ET 52% and theoretical limits 62%. No savings are assumed for “other” technologies that become the dominant energy use in high savings scenarios. (EUI)



**Figure 5.3** Use of ENERGY STAR® technologies would reduce commercial energy consumption 21%, best available technology 46%, goals of ET 47% and theoretical limits 59%. No savings are assumed for “other” technologies that become the dominant energy use in high savings scenarios. (EUI)

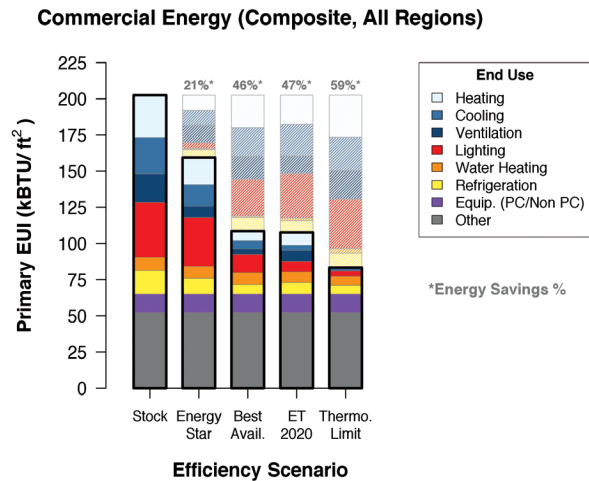


Figure 5.2 and Figure 5.3 compare residential and commercial energy use in the current building stock with buildings using ENERGY STAR® equipment, today’s best available technologies, technologies meeting DOE’s emerging technologies (ET 2020) cost and performance goals, and the energy used if all equipment operated at theoretical efficiency limits (e.g., perfect heat pumps). In most cases, the best available technologies have similar performance to those meeting the ET 2020 goals, but planned research advances will make those technologies cost-effective by 2020.

The cost goals represent the DOE’s analysis of material costs and manufacturing methods judged plausible, including expert solicitations shown in the cited roadmaps.<sup>3</sup> Some of these goals are shown in Table 5.1<sup>4</sup> (see also the supplemental information on roadmaps for this chapter on the web).

Considering only cost-based analysis of new energy efficiency technologies has limitations. For example, features such as improving the ability to comfortably stand by a window on a cold day or changing the color of lighting reflect qualitative values that may affect consumer preferences but would be difficult to analyze quantitatively. None of the economic analysis presented here reflects the social cost of carbon, and none of them reflects services that could be provided to the electric grid (see Chapter 3). Furthermore, the savings shown in the ENERGY STAR® scenario in Figure 5.2 and Figure 5.3 include measures that are cost-effective today but are not being used because of a complex set of market failures.

Capturing the much larger, potential future savings, reflected in the best available ET 2020 and thermodynamic limit scenarios, requires a well-designed research, development, demonstration, and deployment (RDD&D) program, the focus of this chapter. It will also require market-focused programs that encourage rapid adoption of efficient technologies including credible information, standards, labels, and other policies that help consumers understand the costs and benefits of energy-purchasing decisions, and programs to ensure an adequate supply of workers with the skills needed to design, build, and operate new energy systems.

The figures show no reduction in energy used for “other” uses, which include televisions and computer monitors, computers, other electronics, and miscellaneous devices. This is not because their efficiency can’t be improved but because the total is the sum of a very large number of different devices. In many cases,

commercial investment in the technology is driving change so fast that federal applied research will have limited value. Rapidly increasing demand for fast information processing, for example, is facing energy-use limits, which are driving an enormous amount of private research investment. It is important to determine where and how to productively invest in RDD&D that could improve the efficiency of an electronic component used by these products, and depending on research results, private research efforts and competing priorities within budget limitations, the mix of appropriate investments is likely to change over time. As

an example, the development and application of wide band gap semiconductors could reduce energy use in a number of miscellaneous devices but currently has insufficient RDD&D investment to drive this forward in a timely manner. Excluding this “other” category, Figures 5.2 and 5.3 show that building energy use can be reduced by about half.

Buildings last for decades (consider that more than half of all commercial buildings in operation today were built before 1970),<sup>5</sup> so it’s important to consider technologies that can be used to retrofit existing buildings as well as new buildings. Many of the technologies assumed in Figure 5.2 and Figure 5.3 can be used in both new and existing structures (e.g., light-emitting diodes [LEDs]). Retrofits present unique challenges, and technologies focused on retrofits merit attention because of the large, existing stock and its generally lower efficiency. These include low-cost solutions such as thin, easily-installed insulation, leak detectors, devices to detect equipment and systems problems (e.g., air conditioners low on refrigerants), and better ways to collect and disseminate best practices.

Energy use in buildings depends on a combination of good architecture and energy systems design and on effective operations and maintenance once the building is occupied. Buildings should be treated as sophisticated, integrated, interrelated systems. It should also be understood that different climates probably require different designs and equipment, and that the performance and value of any component technology depends on the system in which it is embedded. Attractive lighting depends on the performance of the devices that convert electricity to visible light, as well as on window design, window and window covering controls, occupancy detectors, and other lighting controls. As the light fixture efficiency is greatly increased, lighting controls will have a reduced net impact on energy use. In addition, the thermal energy released into the room by lighting would decrease, which then affects building heating and cooling loads.

Since buildings consume a large fraction of the output of electric utilities, they can greatly impact utility operations. Specifically, buildings’ ability to shift energy demand away from peak periods, such as on hot summer afternoons, can greatly reduce both cost and GHG emissions by allowing utilities to reduce the need for their least efficient and most polluting power plants. Coordinating building energy systems, on-site

**Table 5.1** Sample ET Program 2020 Goals

	Current	2020 goal
Insulation	R-6/in and \$1.1/ft <sup>2</sup>	R-8/in and \$0.35/ft <sup>2</sup>
Windows (residential)	R-5.9/in and \$63/ft <sup>2</sup>	R-10/in and \$10/ft <sup>2</sup>
Vapor-compression heating, ventilation, and air conditioning (HVAC)	1.84 COP and 68.5 \$/kBTu/hr cost premium	2.0 Primary COP and \$23/kBTu/hr cost premium
Non-vapor compression HVAC	Not on market	2.3 Primary COP and \$20/kBTu/hr cost premium
LEDs (cool white)	166 lm/W and \$4/klm	231 lm/W and \$0.7/klm
Daylighting and controls	16% reduction in lighting for \$4/ft <sup>2</sup>	35% reduction in lighting for \$13/ft <sup>2</sup>
Heat pump clothes dryers	Not on market	50% savings and \$570 cost premium

generation, and energy storage with other buildings and the utility can lower overall costs, decrease GHG emissions, and increase system-wide reliability.

The following discussion describes the next generation of research opportunities and priorities using three filters:

- If the research is successful, would it result in a significant increase in building energy performance?
- Is the research likely to lead to a commercially successful product in five to ten years?
- Is there evidence that private research in the field is inadequate?

## 5.2 Thermal Comfort and Air Quality

Providing a comfortable and healthy interior environment is one of the core functions of building energy systems and accounts for about a third of total building energy use. New technologies for heating, cooling, and ventilation not only can achieve large gains in efficiency, but they can improve the way building systems meet occupant needs and preferences by providing greater control, reducing unwanted temperature variations, and improving indoor air quality. Opportunities for improvements fall into the following basic categories:

- Good building design, including passive systems and landscaping
- Improved building envelope, including roofs, walls, and windows
- Improved equipment for heating and cooling air and removing humidity
- Thermal energy storage that can be a part of the building structure or separate equipment
- Improved sensors, control systems, and control algorithms for optimizing system performance

Both building designs and the selection of equipment depend on the climate where the building operates.

### 5.2.1 The Building Envelope

The walls, foundation, roof, and windows of a building couple the exterior environment with the interior environment in complex ways (see Table 5.2).<sup>6</sup> The insulating properties of the building envelope and construction quality together control the way heat and moisture flows into or out of the building. The color of the building envelope and other optical properties govern how solar energy is reflected and how thermal energy (heat) is radiated from the building. Windows bring sunlight and the sun's energy into the building. About 50% of the heating load in residential buildings and 60% in commercial buildings results from flows through walls, foundations, and the roof (see Table 5.2).<sup>7</sup> Virtually the entire commercial cooling load comes from energy

**Table 5.2** Energy Flows in Building Shells (Quads)

Building component	Residential		Commercial	
	Heating	Cooling	Heating	Cooling
Roofs	1.00	0.49	0.88	0.05
Walls	1.54	0.34	1.48	-0.03
Foundation	1.17	-0.22	0.79	-0.21
Infiltration	2.26	0.59	1.29	-0.15
Windows (conduction)	2.06	0.03	1.60	-0.30
Windows (solar heat gain)	-0.66	1.14	-0.97	1.38



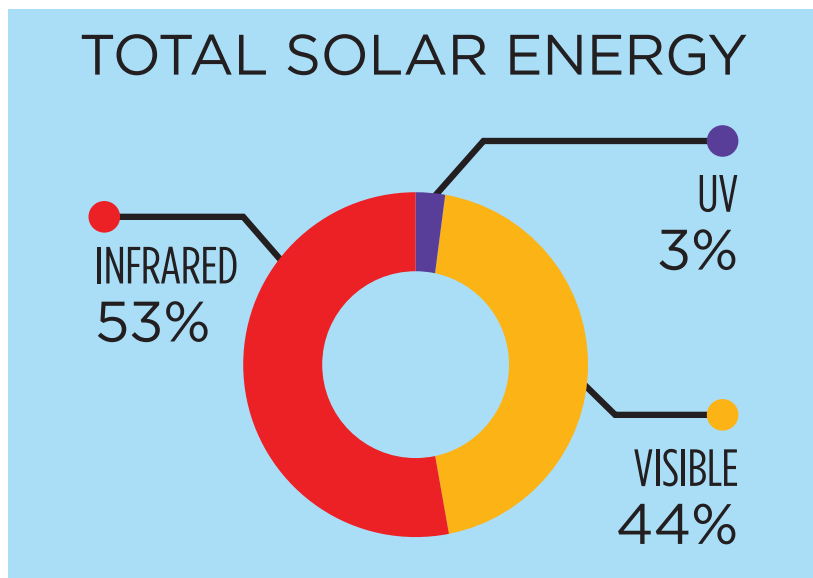
entering through the windows (i.e., solar heat gain). The bulk of residential cooling results from window heat gains although infiltration also has a significant role. Future cooling may be a larger share of total demand since U.S. regions with high population growth are largely in warmer climates.

## Windows and Skylights

The quality of a window is measured by its insulating value<sup>8</sup> and its transparency to the sun's visible and infrared light<sup>9</sup> recognizing that an ideal system would allow these parameters to be controlled independently. An ideal window would provide attractive lighting levels without glare, high levels of thermal insulation, and allow infrared light to enter when it is useful for heating but block it when it would add to cooling loads (see Figure 5.4).<sup>10</sup> It would also block ultraviolet light that can damage skin and materials.

**Figure 5.4** Only 44% of the energy in sunlight is visible light.

Credit: PPG Industries, Inc.



Windows should also be effective parts of building climate control and lighting systems. Without active control of optical properties, static window requirements will depend on the climate, orientation, and interior space use. If cooling loads dominate, windows that block the invisible (i.e., infrared) part of the solar spectrum are desirable.

Significant progress has been made in window technology over the past three decades. Thanks in large part to DOE's research investment, sealed windows (multiple panes sealed in a factory) now comprise about 95% of windows sold for residential installation and 89% of windows sold for nonresidential installation.<sup>11</sup> Low-emissivity ENERGY STAR® windows make up more than 80% of the market<sup>12</sup> and are twice as insulating as the single-glazing windows that were the default option for generations.

Innovations include glass coatings that reduce absorption and re-emission of infrared light, thermal conductivity improvements (e.g., multiple panes of glass, filling gaps between glass panes using argon, krypton, or xenon,<sup>13</sup> and improved frame design), and the use of low-iron glass to improve visible clarity. Commercial products are now available that provide seven times the insulation provided by single-glazing windows without compromising optical properties. A typical single-glazed window has an R value of one, but R-11 glazing materials and combined frame/glazing units with R-8.1 are commercially available.<sup>14</sup> The "solar heat gain coefficient" is a measure of the fraction of total sunlight energy that can pass through the window while the "visual transmittance" measures the fraction of visible sunlight that gets through. A typical single-glazed window has a solar heat gain coefficient and visual transmittance of about 0.7. Commercially available windows can come close to this with a transmittance of 0.71 and a solar heat gain coefficient that can be selected in the range 0.29–0.62.<sup>15</sup> Window frames transmit unwanted heat directly through rigid materials. While progress has been made both in insulating framing materials and in frame design to reduce conduction, challenges still remain. Durable edge seals remain a challenge, and stress under large temperature differences remains problematic.

The biggest challenge is providing superior performance at an affordable cost. There are also practical considerations. Windows with three or four layers of glass are too heavy and costly for most conventional installations. Using a vacuum between the panes eliminates conduction and convection completely, but it requires very small spacers or other mechanisms to keep the glass panes from touching.<sup>16</sup> The cost of highly insulating windows using filler gas would be reduced if the price of producing the gas can be cut (they are now made by liquefying air) or if substitutes are found.<sup>17</sup>

In summary, all current approaches face cost and visual quality challenges.

### Building Walls, Roofs, and Foundations

The walls, roofs, and foundations of buildings also control the flow of heat, moisture, and air. Their color and other optical properties affect the way heat is absorbed and how the building radiates heat back into the atmosphere, but they must do so in ways that meet aesthetic standards and serve functions such as building stability and fire-resistance. Ideal materials are thin, light, and easy-to-install, and provide opportunities to adjust their resistance to flows of heat and moisture.

Thin materials offering high levels of insulation are valuable for all building applications but are particularly important for retrofits since space for additional insulation is often limited. Promising approaches include vacuum insulation<sup>18</sup> and lightweight silica aerogel.<sup>19</sup> Flexible insulation materials with thermal resistance of nearly R-10 per inch are available from several suppliers. Because of high costs, use of these insulating materials has been limited to industrial applications such as pipelines, although building applications have been explored.<sup>20</sup> More federal research here is justified only if there is evidence that there are significant opportunities to find novel materials that offer high levels of insulation in thin products that can cost-effectively meet fire, safety, and other building code requirements that the private sector is not pursuing on its own. The new materials must also be practical for construction—ideally it should be possible to cut, bend, or nail them.

More work is needed in tools and methods to measure and continuously monitor heat and moisture flows through building shells.<sup>21</sup> This includes analytical tools capable of converting sensor data into actionable information about the source of failures in insulation and vapor barriers.

Building shells also affect the way buildings absorb and radiate heat. Ideally, the optical properties of building materials would be adjustable to changes in the weather and other external conditions such as sunlight. Current technologies don't allow dynamic control, and designs often use a solution that optimizes annual performance even if it isn't ideal in extreme conditions. In situations where air conditioning is a significant load, roofing should reflect sunlight instead of absorbing it and be able to efficiently radiate heat from the building. New roofing materials are available that help reduce cooling loads in buildings, lengthen the life expectancy of roofing materials, and cut the "heat island" effect in which buildings and other artificial surfaces heated by the sun actually increase the ambient temperature of cities.<sup>22</sup>

It has proven difficult to find materials that can both reflect the sun's energy and radiate heat during the daytime (when radiative cooling would be most important). Radiating infrared is particularly difficult in areas with significant humidity since water vapor in the air blocks most infrared transmission. This problem has recently been overcome in a laboratory-scale sample. A material created from seven layers of hafnium oxide and silicon dioxide reflects 97% of the sun's shortwave energy while radiating infrared heat at such a high rate that the material was 5°C below ambient temperatures, even in strong sunlight. It achieves this by having very high emissions in the narrow range of infrared where the atmosphere is transparent to infrared (between eight and thirteen micrometers).<sup>23</sup>

## 5.2.2 Ventilation and Air Quality

Many people spend most of their time indoors, and the quality of indoor air has a significant impact on their health and comfort.<sup>24</sup> Inadequate ventilation can make a room stuffy and uncomfortable. Exposure to indoor pollutants such as mold, radon, secondhand smoke, pressed wood products (that may contain formaldehyde), and other materials can lead to health effects, including asthma and lung cancer. Moisture buildups can also lead to structural damage to the building.<sup>25</sup>

These problems can be addressed most effectively by minimizing and managing pollutant sources in the building. Problems that remain after steps have been taken to reduce pollutants can be addressed by improved building design and operations, as well as by systems bringing in filtered, outside air and exhausting contaminated interior air.<sup>26</sup> Fresh air may infiltrate the building unintentionally through leaks or through controlled ventilation. Standards typically require different minimum-ventilation rates for different space-use types and occupant densities. Some facilities, such as hospitals and labs, require significantly more fresh air than others.<sup>27</sup> However, increased ventilation increases energy consumption when unconditioned, outside air must be heated or cooled as it replaces conditioned, indoor air that is being exhausted. In 2010, unwanted residential air leaks were responsible for more than two quads of space-heating energy loss and one-half quads of space-cooling energy loss, and more than one quad of commercial heating energy loss.<sup>28</sup> Building codes specify maximum allowed leakage, but detecting leaks can be difficult and expensive, and compliance rates are often poor.<sup>29</sup> New technologies, such as the Acoustic Building Infiltration Measuring System, may improve accuracy and reduce costs.<sup>30</sup>

There are many ways to reduce the energy lost in ventilation systems, which include the following:

- **Reduce leaks in building shells and ducts:** While minimizing uncontrolled infiltration is a critical part of building design and construction, locating and fixing leaks in existing buildings presents a greater challenge, especially in commercial buildings where pressurization tests cannot be easily used to measure and locate leaks. DOE research led to the development of material that can be sprayed into existing ducts to seal leaks from the inside.<sup>31</sup>
- **Use natural ventilation where possible:** In some climates and at certain times of the year, natural ventilation can be used to introduce fresh air using natural circulation or fans. Good building design, carefully chosen orientation, windows that open, and ridge vents are some of the many strategies that can be used.<sup>32</sup> Economizers are devices that bring in fresh air when appropriate and can reduce cooling loads by 30% when operated by a well-designed control system. Economizer designs that minimize or eliminate failures can be important for efficiency, but a significant fraction of installed economizers may not be operative because of poor maintenance.<sup>33</sup> The next generation of sensors and controls can automate detection and maintenance notification to help address this issue, and economizer designs can be improved to minimize maintenance.
- **Advanced sensor and control systems provide ventilation only where and when it's needed:** Most installed systems implement fixed air-exchange rates as specified by code, but ventilation needs depend upon occupancy, building purpose and internal activities, and other factors (e.g., a hospital). Significant efficiencies could be gained if ventilation systems provided only the fresh air needed to maintain required levels of carbon dioxide (CO<sub>2</sub>) and other compounds. Such systems are known as demand-controlled ventilation. Modern systems can use sensors to detect concentrations of CO<sub>2</sub> and other contaminants, and this information can be used to make appropriate adjustments to ventilation rates. However, keeping them in calibration has proven difficult. Good control systems may be able to reduce ventilation-related energy use in residences by as much as 40%.<sup>34</sup>

- **Use efficient, variable speed motors:** Most ventilation systems adjust flow rates only by turning motors off and on or by using dampers. Significant energy savings can be achieved using efficient, variable air volume systems with variable-speed fans along with properly designed and sealed ducts.<sup>35</sup> There are also major opportunities for improving the efficiency and lowering the cost of variable speed motors and motor controls.<sup>36</sup> Innovations that improve the performance and lower the cost of wide bandgap semiconductors are an important part of this work (see Chapter 6).
- **Use heat and moisture exchange devices:** Even greater energy savings can be achieved by using heat exchangers that allow incoming cool air to be heated by warm building air being exhausted (or the reverse if the building is cooled). Advanced systems can also exchange moisture (i.e., enthalpy exchangers). These systems are discussed in the section on heat pumps.

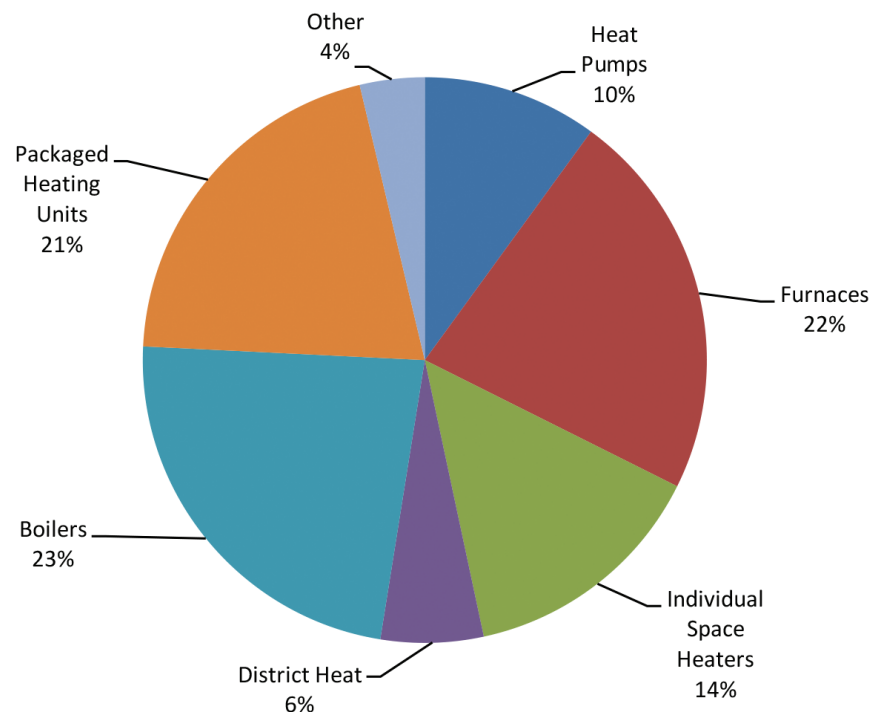
It has been particularly difficult to get advanced systems into smaller buildings. More than half of buildings larger than 10,000 square feet use economizers and variable air volume systems, but less than 10% of buildings smaller than 10,000 square feet use them.<sup>37</sup> Technologies that are inexpensive and easy to use in smaller buildings would be particularly useful.

### 5.2.3 Space Conditioning Equipment

Although well-designed building envelopes can dramatically reduce heating and cooling loads, there will always be a need for mechanical systems to condition air. Fresh outdoor air will need to be brought into the building and conditioned to replace exhaust air and the heat and moisture generated by occupants and building equipment will need to be removed.

Space conditioning involves two distinct operations: 1) increasing or decreasing air temperature (i.e., adding or removing “sensible heat”), and 2) humidifying or dehumidifying air (i.e., adding or removing “latent heat”).

**Figure 5.5** Types of Building Heating Equipment



Because warmer air can also contain more moisture (water vapor), heating usually needs to be coupled with humidification and cooling with dehumidification. Traditional air-heating equipment includes furnaces and heat pumps (see Figure 5.5).<sup>38</sup> About half of the floor space is heated with systems that burn fuels and produce CO<sub>2</sub> that cannot practically be captured or sequestered with conventional technology. In large commercial buildings, space heating typically uses boilers to heat water, piping the hot water to spaces (i.e., offices and other rooms), and then blowing air over compact hot water coils or running the coils through the floor or wall and radiating heat into the space. These systems require a separate, dedicated outdoor air system to bring in fresh air. The combination of water pipes/pumps and small air ducts/efficient fans not only requires less energy than large air ducts, it also needs less space between floors.

Air conditioning involves both cooling the air and removing moisture. The traditional approach does both using vapor-compression heat pumps. Smaller systems, including most residential systems, move conditioned air while most large commercial buildings use central chillers to cool water and transfer heat from water to air closer to the occupied spaces. Dehumidification is the process of taking water out of air, and it accounts for nearly 3% of all U.S. energy use. It is typically achieved by inefficiently cooling moist air until the water vapor condenses out and then re-heating the air to a comfortable temperature, which is an inefficient process. Efficiency improvements in heating, ventilation, and air conditioning (HVAC) systems will involve efforts to improve the efficiency of heating or cooling air and technology that can efficiently remove moisture from air.

Heat pump systems are often used for heating in regions where natural gas<sup>39</sup> is not available. Next-generation cold weather heat pumps can be cost effective in a wide range of climates. Current heat pumps lose 60% of their capacity and operate at half the efficiency when operating at -13°F. Work is underway to develop a heat pump capable of achieving a Coefficient of Performance (COP)<sup>40</sup> of 3.0 for residential applications at that temperature (compared with a COP of 3.6 for an ENERGY STAR® heat pump operating with no more than a 25% reduction in capacity).<sup>41</sup> Work is also underway to improve the performance of cold-weather gas furnaces.<sup>42</sup> Heat pumps have the advantage of providing both heating and cooling with a single unit offering an opportunity to lower initial costs.

Vapor-compression heat pumps and air conditioners rely on refrigerants (working fluids) such as hydrofluorocarbons that have a significantly higher global warming potential (GWP) than CO<sub>2</sub> when they are released to the atmosphere.

The search for substitutes has proven difficult since alternatives present challenges in toxicity, flammability, lower efficiency, and/or increased equipment cost. It is an area of active, ongoing research by the National Institute of Standards and Technology (NIST) and others.<sup>43</sup> See Table 5.3 for more information.<sup>44</sup>

There is a number of promising heat-pump technologies that have the potential to increase system efficiency and eliminate refrigerants with high GWP.<sup>45</sup> Some use vapor-compression with CO<sub>2</sub>, ionic

**Table 5.3** Non-Vapor Compression Heat Pump Technologies

**Magnetocaloric:** Certain paramagnetic materials undergo temperature changes when placed in magnetic fields. Specifically, they undergo heating when a magnetic field aligns the magnetic dipoles of their atoms and cooling when the field is removed and dipole directions randomize.

**Thermoelectric:** Current flowing through two different semiconductors can either add or remove heat at the junction.

**Thermoelastic:** Shape-memory alloys heat up when physically stressed and cool down when stress is removed.

**Electrochemical:** This device uses a membrane that allows protons but not electrons to pass through. When a voltage is applied across the membrane, protons (hydrogen nuclei) accumulate at pressure on one side of the membrane. This leads to compressed hydrogen on one side of the membrane which can create cooling when expanded.

**Electrocaloric:** This device uses a dielectric that is heated when exposed to an electric field and gives off heat when the field is removed.

liquids, water, and various combinations as working fluids. Heat pumps can also be built that do not require vapor compression (see Table 5.3). There are also opportunities to improve thermally driven technologies using adsorption and absorption devices and duplex-Stirling heat pumps.

While a key interest in developing these new approaches is to reduce GHG emissions, some can exceed the efficiency of current vapor-compression units.

#### 5.2.4 Moisture Removal

Well-designed building shells and foundations can greatly reduce moisture infiltration, but residual moisture transfer coupled with moisture generated by people and building operations will continue to make moisture removal a priority in building energy systems. A number of new approaches do not require heat pumps and could lead to major gains in efficiency. Membrane technologies allow water vapor to pass but block the passage of dry air or can be used to separate moisture from air using only the difference in vapor pressure, passing thermal energy from outgoing to incoming air. Alternatively, these systems may develop a vacuum on one side of the membrane and then compress and exhaust the water vapor removed. These systems can be combined with evaporative cooling stages to provide both dehumidification and chilling.<sup>46</sup>

#### 5.2.5 Heat Exchangers

Heating and cooling systems depend on devices called “heat exchangers” that transfer heat from the surfaces of the equipment, usually metal surfaces, to air. Efficient heat exchangers are typically large and expensive. It may be possible to greatly improve heat exchange efficiency through improved designs such as microchannel devices<sup>47</sup> or the rotating heat exchanger.<sup>48</sup> New manufacturing methods as discussed in Chapter 6, including additive manufacturing, may allow production of heat exchange designs not possible with traditional approaches, which could increase the efficiency of commercial air conditioners by as much as 20%.<sup>49</sup>

#### 5.2.6 Thermal Storage

The performance of building heating and cooling systems and the electric grid system serving the building can be enhanced by systems that store thermal energy, particularly cooling capacity. Thermal storage can be provided with a number of different technologies and a number of commercial products are available.<sup>50</sup> Approaches include the following:

- Designing buildings to store and remove thermal energy in the mass of the building itself (i.e., floors, support columns, etc.)
- Using ice and other phase change materials

Since chillers are more efficient when outdoor air is coolest, systems that pre-cool buildings in the early morning can result in energy savings. Chillers can also store cooling capacity by pre-cooling chilled water or ice during night hours and then shutting off the vapor compression systems during peak cooling demand periods in the afternoon. This can yield small site energy savings through chiller efficiency improvements during the cooler nighttime hours, but the largest site benefit of thermal energy storage lies in reducing the site peak demand and peak energy usage. Shifting energy demand away from peak periods could improve electric utility operations by requiring fewer generation plants to be brought on line and reducing the need to build new plants and distribution systems.<sup>51</sup> Thermal storage could also be a dispatchable asset, mitigating problems associated with the intermittent output of wind and solar energy systems. Such systems must be operated as part of an integrated building control system (this is discussed in a subsequent section of this report).

#### 5.2.7 Integrated System Analysis

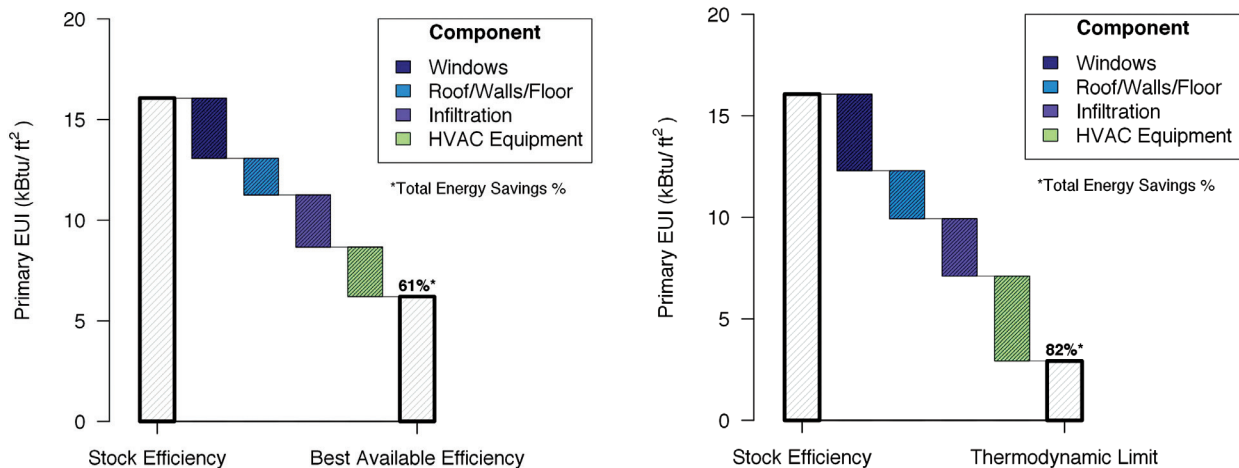
Taken together, the technologies described above can achieve major improvements in efficiency. Figure 5.6 through Figure 5.9 summarize some of the cost and performance goals for key technologies and estimate the

associated energy savings if they fully penetrate potential markets.<sup>52</sup> Figure 5.6 shows that a new residence, built using the best available technology today, could reduce its cooling energy needs by 61% while systems operating at the thermodynamic limit would see an 82% reduction.

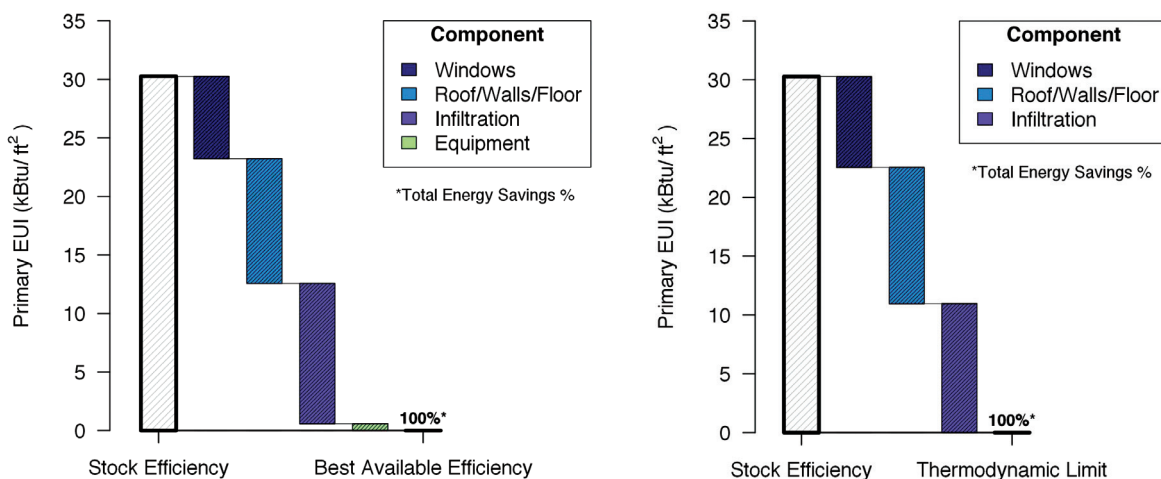
This analysis assumes that improvements in windows and the opaque envelope were applied first, since they are passive approaches, and the remaining cooling demand was then met with more efficient equipment. As a result, envelope improvements are shown as contributing more to the overall primary energy use intensity reductions in both cases.

The savings potential of residential heating is even greater since the occupants and household appliances and other devices generate enough heat to meet a large fraction of the home's heating needs given high quality insulation, windows, and controlled ventilation (Figure 5.7).

**Figure 5.6** Use of the most efficient wall, window, and HVAC equipment now available could reduce residential cooling 61%. The theoretical limit is an 82% reduction.

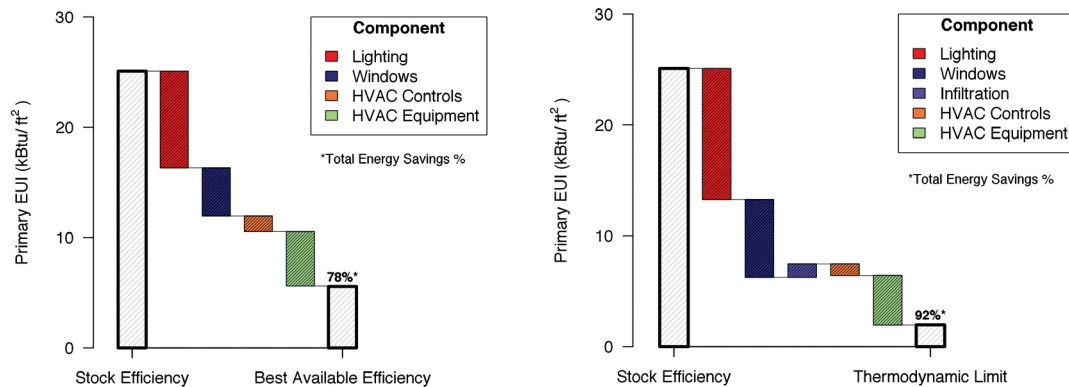


**Figure 5.7** Use of the most efficient wall, window, and HVAC equipment now available could eliminate residential heating.

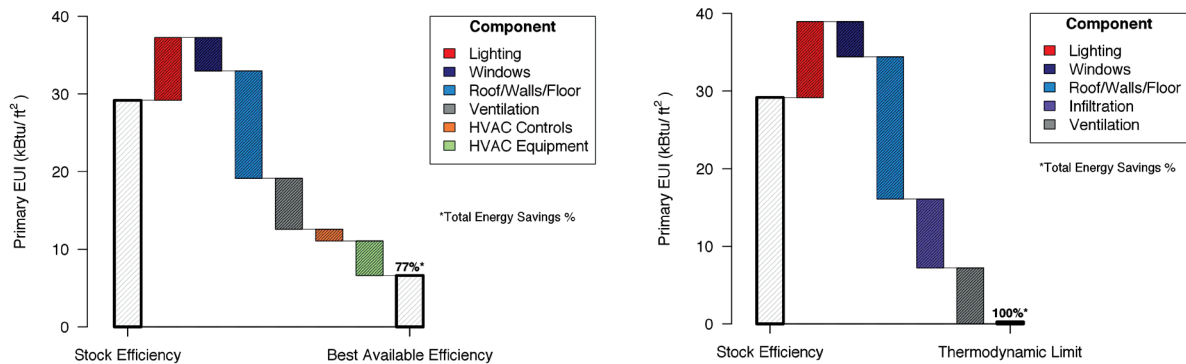


The results for commercial buildings differ in part because lighting plays a large role in energy use. Improved lighting efficiency decreases the heat energy released into the building by the lighting systems and thus reduces the demand for cooling (Figure 5.8). In the heating season, increasing lighting efficiency actually increases the demand for heating energy. This can be offset by improved insulation and heating equipment (Figure 5.9). These summary figures cover all building types and U.S. climate regions; actual building loads will depend heavily on climate region, size, and other design features.

**Figure 5.8** Use of the most efficient wall, window, and HVAC equipment now available could reduce commercial cooling 78%. The theoretical limit is a 92% reduction.



**Figure 5.9** Use of the most efficient wall, window, and HVAC equipment now available could reduce commercial heating 77%. Increased lighting efficiency increases the load met by heating systems.



## 5.2.8 Research Opportunities

Primary areas for improving the efficiency and quality of building thermal comfort are the following:

- Materials that facilitate deep retrofits of existing buildings (e.g., thin insulating materials)
- Improved low-GWP heat-pumping systems
- Improved tools for diagnosing heat flows over the lifetime of a building
- Clear metrics for the performance of building shells in heat management and air flows



A detailed discussion of research opportunities for windows and wall materials can be found in a DOE report on windows and buildings envelope RDD&D,<sup>53</sup> and a detailed discussion of advanced non-vapor compression heat pumps can be found in a report on that topic.<sup>54</sup> In brief, areas where fundamental research problems remain unresolved include the following:

- Glazing materials with tunable optical properties (transmissivity and emissivity adjustable by wavelength) including materials that could be applied to existing windows
- Materials that are thin and provide tunable insulating and vapor permeability and materials that could be used in next-generation enthalpy exchange devices
- Technologies that could lower the cost of producing noble gases and identifying transparent, low-conductivity gases that could substitute for noble gases
- Strategies for using vacuum as a window insulation
- Innovative heat exchanger designs for heat pumps and other uses (variety of scales) that reduce the volume and weight of heat exchangers
- New ways to enhance ventilation and health that are cost-effective, energy-efficient, and practical to implement
- Improved ways to control moisture transfer into and out of buildings
- Components for non-GHG heat pumps including magnetocaloric, thermoelastic, thermoelectric, electrochemical, and electrocaloric systems

In a number of cases, the technology for achieving needed system performance is known but products are too expensive. In most cases, costs will decline as production volumes increase. Emphasis should also be placed on lowering manufacturing costs. In some cases, finding inexpensive materials is also important. Areas with opportunities include electrochromic windows, variable speed motors, vacuum insulation/advanced insulation (e.g., aerogel), sensors, and controls.

Continuing research brings the goal of creating a “net-zero energy façade or envelope” within reach. A window could reduce a building’s need for external energy sources more than a highly-insulated opaque wall. While the specifics vary with location and orientation, the opportunities to do this include: 1) reduce thermal losses by a factor of two to three below current code requirements; 2) provide active control of solar gain and daylight over a wide range; 3) introduce sufficient daylight to adequately light the outer thirty-foot depth of floor space; and 4) use natural ventilation when it can offset HVAC use. These systems require careful integration with other building systems to be effective and to provide the required levels of thermal and visual comfort.

### 5.3 Lighting

Lighting quality plays an essential role in the appeal and safety of interior and exterior spaces. Well-designed lighting systems can enhance productivity while glare and other harsh lighting features can decrease it.<sup>55</sup> Light quality also affects sleep patterns and health<sup>56</sup> and can shape the mood of any space. About 18% of U.S. electricity consumption and 6% of all U.S. energy consumption is used to provide indoor and outdoor lighting.

The goal of the DOE lighting research is to give designers the strategies and the devices that can provide optimal lighting performance while minimizing energy use. The new technologies can do much more than match existing lighting system performance with far less energy use. They can improve the quality of lighting by allowing greater user control including an ability to select color as well as intensity. The new lighting systems may be able to operate for decades without replacement or maintenance.

The key strategies for improving the efficiency and quality of lighting are good building and lighting design, window and window covering technologies (such as blinds and diffusers), lighting sensors and controls (including occupancy sensors and light sensors), and lighting devices (LEDs and others). Good lighting design can ensure that light levels are adjusted to user requirements. Intense task lighting may be needed for detailed work while much lower levels are needed in hallways.

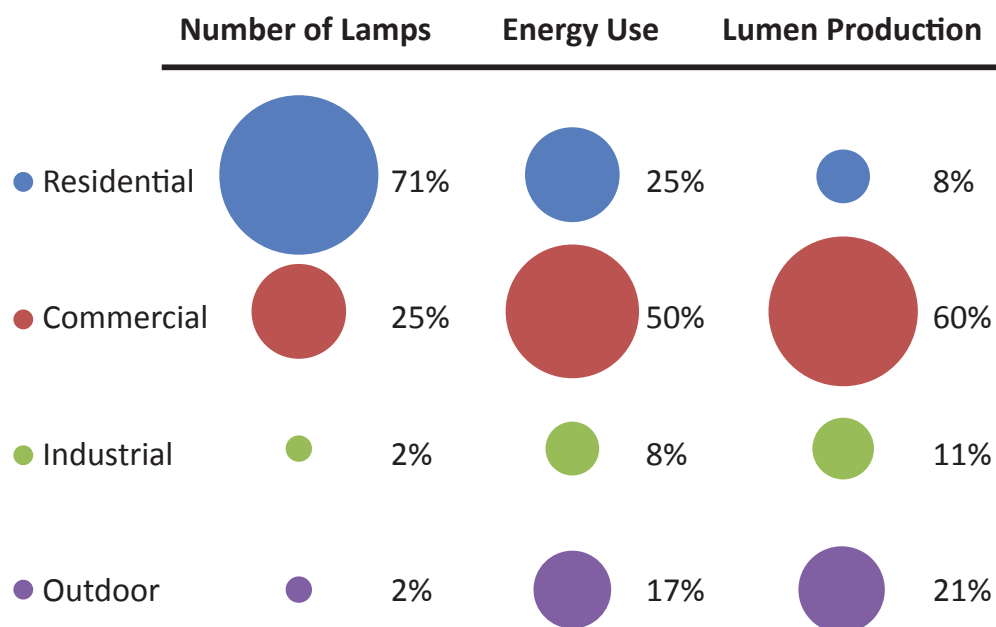
Since each of these elements is influenced by the others, it is important to evaluate each as a part of an integrated system. It must also be recognized that lighting, whether provided by daylight or by artificial light, can have a significant impact on heating and cooling loads. The energy and environmental impacts of lighting systems must always be considered as a part of integrated building performance.

While 71% of all lamps in the United States are installed in residential units (Figure 5.10), commercial building lighting is by far the largest consumer of energy and lumens (lm).<sup>58</sup> Although only 29% of lamps are installed in commercial buildings, these buildings make significantly heavier use of fluorescent lighting fixtures—which on average use four times less electricity to produce a lumen than a typical residential incandescent lighting fixture.

The market for efficient lamps, driven in part by regulations, is rapidly changing the lighting market. Electricity used for lighting fell 9% between 2001 and 2010 even though the number of installed lamps increased by 18%.<sup>59</sup> The efficiency of a lighting unit is best measured by the lumens produced for each unit of electricity consumed, lumens per watt (lm/W). Lumens are a measure of light the human eye actually perceives. A candle produces about 12.6 lm and a traditional 100W incandescent light bulb produces about 1700 lm. The human eye is much more efficient at processing green light than it is processing deep reds or blues, and we are completely blind to infrared and ultraviolet (see Figure 5.11). The efficiency of incandescent bulbs is about 17 lm/W while a good fluorescent bulb can achieve 92 lm/W.<sup>60</sup>

**Figure 5.10** Most light fixtures are in residences, but the bulk of lighting energy is in commercial buildings. The average commercial device is 3.6 times as efficient but is in use more than six times (in hours) as much per day.<sup>57</sup>

Credit: Navigant Consulting



**Figure 5.11** The efficiency of the human eye is highest for green light at 683 lumens per watt.

Credit: E. Fred Schubert, *Light Emitting Diodes*. Second Edition. Cambridge University Press (2006).

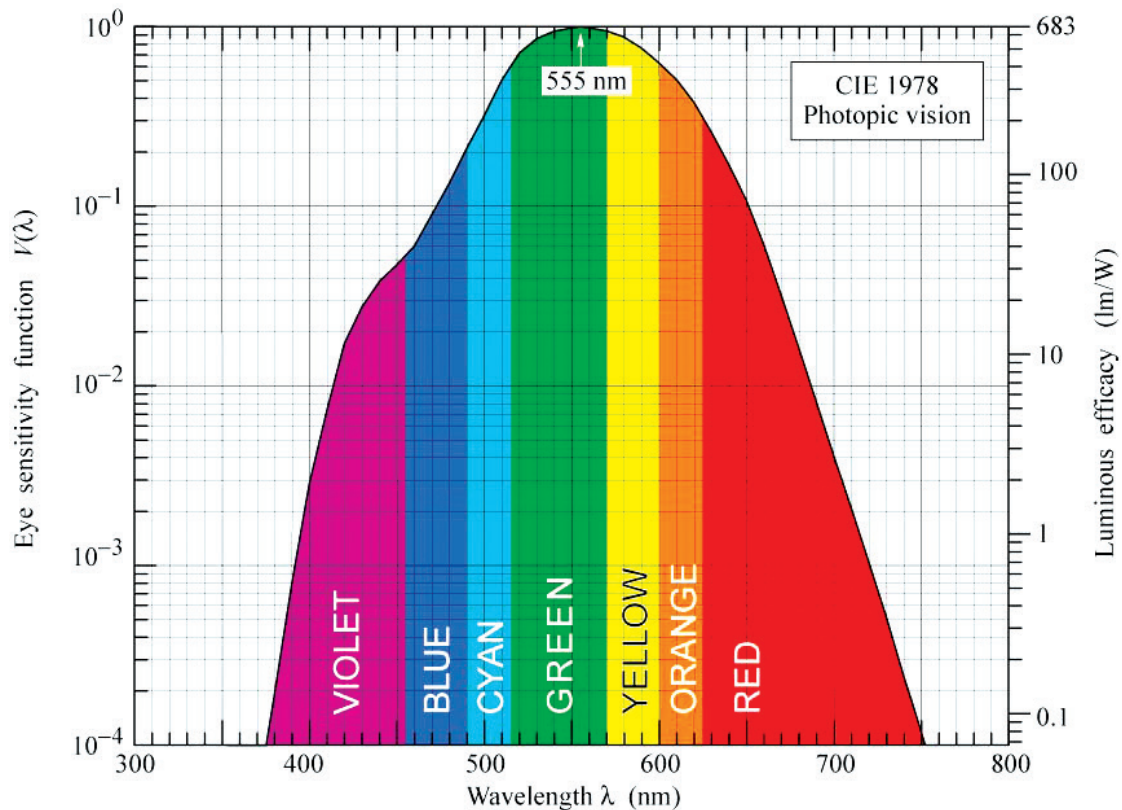


Figure 5.11 shows that one watt of energy in the form of green light results in 683 lm. This means that the absolute limit of a light device's efficiency is 683 lm/W. White, of course, is a mixture of many different colors and therefore seeing it requires eye receptors that are much less efficient than the green peak (Figure 5.11). There has been extensive analysis of what qualifies as an acceptable “white light.”<sup>61</sup> The “white” that is acceptable depends on what is being illuminated (i.e., food, living areas, or streets), and there may be cultural differences.<sup>62</sup> Preferences for “warm” colors with more red or preferences for “cool” colors, which more closely match sunlight on a clear day, depend on a range of individual tastes.<sup>63</sup> New lighting technology, which allows a range of color and even an ability to adjust light color, will allow this diversity to be expressed in the marketplace.<sup>64</sup>

Taken together, the potential of daylighting, controls, and more efficient devices can be enormous. And the impact could be rapid if lighting devices, lighting sensors, and lighting controls were easily retrofit without major renovations.

### 5.3.1 Windows, Daylighting, and Lighting Controls

Daylight provided by windows can make a major contribution not only to the ambiance of indoor environments but to reducing a building's demand for artificial light. Windows account for about four quads of energy in terms of their thermal impacts and can influence another one quad. This complex connection to other building energy systems means that windows and daylighting sensors and controls can only be understood as a part of an integrated building system analysis. This integrated design impact will be considered later in this report.

Invisible sunlight (most of it in the near infrared) is important for building heating and cooling—and possibly can be used as a source of energy using photovoltaic (PV) cells designed to transmit visible daylight and use the remaining infrared light energy to generate electricity.<sup>65</sup>

From a lighting perspective, an optimal window would provide attractive light levels throughout the day while avoiding glare and unpleasantly intense light on surfaces such as computer screens. It would allow the user to control the amount of visible daylight transmitted through the window—possibly altering the direction of the transmitted light and adjusting transmission by color. Windows with varying optical properties can be built using mechanical systems such as adjustable blinds or louvers. Glazing can have adjustable optical properties such as thermochromic windows that automatically change transmissivity in response to temperature and electrochromic windows that change with electronic controls.<sup>66</sup> Light pipes, light shelves, and skylights to direct sunlight from roofs deep into buildings can lead to large savings, but these will depend on effective building designs. Advances in optics and manufacturing of dynamically-controlled windows make it possible to redirect light into the window material itself.<sup>67</sup>

The energy needed to control an active window device is generally small compared to the available sunlight, so window and lighting control systems can harvest energy for their own operations from sunlight, greatly simplifying installation. Several self-powered systems are commercially available today.

The challenge for all advanced window control systems has been cost, controls integration, and in some cases, durability. It has proven difficult, for example, to develop electrochromic films with variable optical properties that transmit a high fraction of the incoming daylight (e.g., 60% or more) when set to be fully transparent, switch to a very low level in the dark state, are color neutral, switch rapidly, and operate for approximately 50,000 cycles.<sup>68</sup>

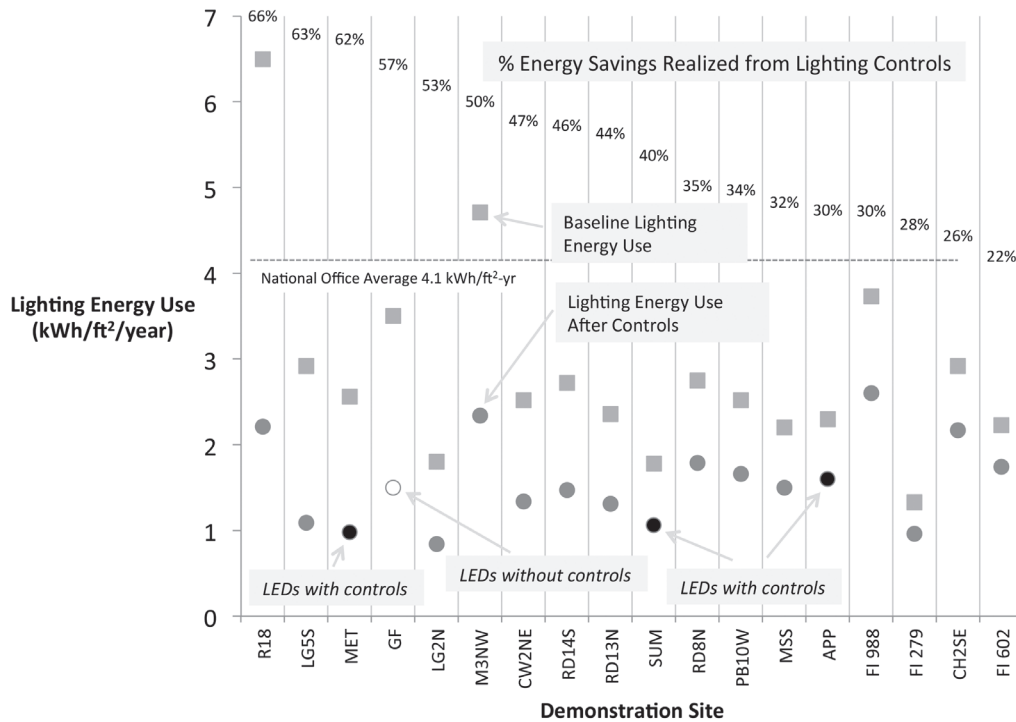
High-cost systems have found markets in specialty applications. A case in point is Boeing's 787 aircraft with tunable windows that can be controlled by the crew and individual passengers. At least two manufacturers in the United States have now invested in state-of-the-art manufacturing facilities to produce large-area, high-performance electrochromic coatings. The final price to end users is still too high for widespread adoption although they are being installed by early adopters and some costs can be offset by certain techniques, e.g., reduced chiller size for a reliable smart coating that reduces solar heat gain. Promising research using novel materials with low cost manufacturing processes (e.g., solution based) may also have potential to dramatically reduce costs.

Good lighting systems also depend on inexpensive sensors and controls. These include detecting when people enter a space and measuring light and color levels of key surfaces. It has proven difficult to build reliable, inexpensive occupancy sensors but steady improvements are being made. Further progress is needed in areas such as the quality of the sensors, system commissioning and continuous monitoring of system performance, combining sensor information with other information that can indicate occupancy (e.g., electricity consumption or computer use), and improved algorithms to extract information from multiple data streams (some of which may contain errors).<sup>69</sup>

While it is difficult to assign a precise value to good design, recent studies indicate that good designs can achieve impressive results. A meta-study of daylighting and control systems showed a wide range of savings without using new high-efficiency lighting devices (see Figure 5.12).<sup>70</sup> Savings range from an average of 30% using only occupancy sensors to an average of 45% when daylighting and more sophisticated controls were used. The U.S. Department of Defense also examined the performance of three advanced lighting systems and was able to achieve savings above 40% using only improved sensors, lighting design, and control systems.<sup>71</sup>

**Figure 5.12** Energy Savings from Lighting Retrofits

Credit: Lawrence Berkeley National Laboratory



### 5.3.2 Lighting Devices

While many lighting technologies are commercially available, the technology most likely to dominate the future is the LED. There are two major classes of LEDs: crystalline semiconductor devices LEDs that have many of the characteristics of silicon-based computer chips, and organic LEDs (OLEDs), which use organic materials that have the characteristics of semiconductors.<sup>72</sup> Laboratory LED devices have been demonstrated that approach 300 lm/W,<sup>73</sup> which is beginning to approach the 400 lm/W theoretical maximum efficiency for an acceptable white light. The most efficient commercial products today have efficiencies between 120 and 160 lm/W. Remaining research challenges include efficiency improvements, cost reduction, reliability, color consistency, and compatibility with dimmers and other controls.

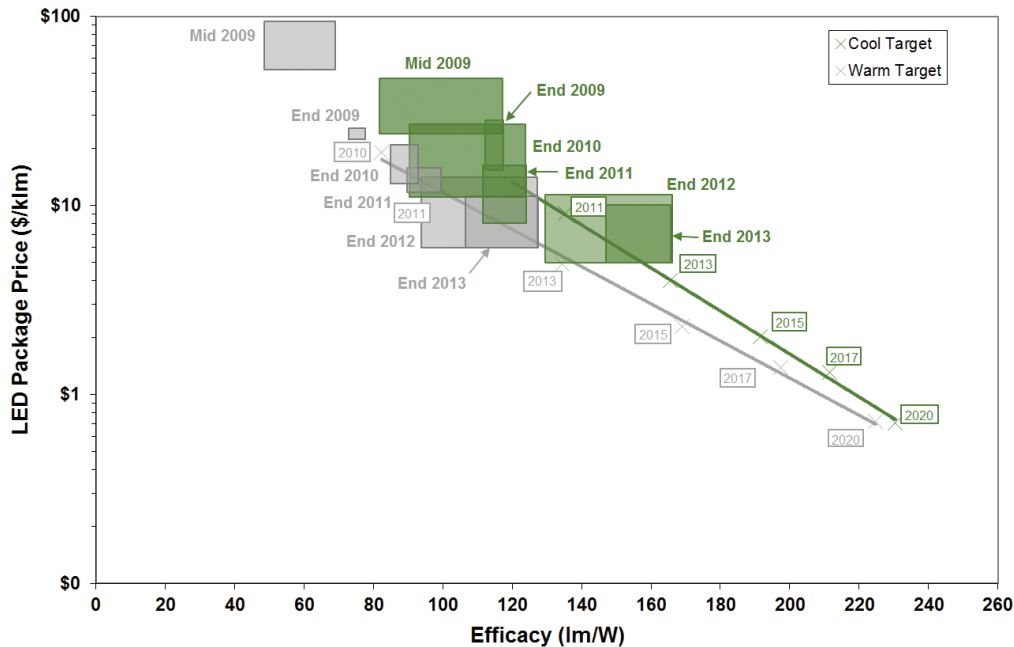
The combination of federal and private research has driven rapid increases in LED efficiencies and driven down the cost per lm of LED products (see Figure 5.13).<sup>74</sup>

Three approaches have been taken to produce a LED with high efficiency and acceptable light quality. These include the following:

- Combining three or four single-color LEDs to produce an acceptable approximation to an incandescent light source. These are chosen to match at red, green, and blue eye receptors. Amber LEDs are sometimes added to achieve better color quality. One advantage of this approach is that the different LED devices can be dimmed separately allowing users to control the color.
- Use of high efficiency blue LEDs to illuminate a phosphor, which then re-radiates the light over a broad range of colors.
- Hybrid approaches that use LED colors with comparatively high efficiency and produce green or other colors using a phosphor.

**Figure 5.13** The price and performance of LEDs have steadily improved since 2009.

Credit: Navigant Consulting



One of the challenges in using multiple LEDs has been the low efficiency of green LEDs. Table 5.4 shows the performance challenges facing LEDs that use phosphors to convert blue LED output into other colors.<sup>75</sup> Significant improvements are needed in both green and red phosphors.<sup>76</sup>

Quantum dots, which are nanoscale semiconductor structures, can substitute for phosphors, but challenges remain in achieving high efficiency without use of cadmium.<sup>77</sup> Innovations are also needed to improve the fraction of light that actually leaves the device (as opposed to being absorbed internally) and the electronic subsystems that provide dimming and convert alternating current (AC) plug power into the direct current (DC) required by the lights. Color reliability and guaranteed lifetimes are also a challenge.

Research teams have been attempting to achieve efficiency, reliability, and other targets that would make them convincing competitors to other LEDs. While progress has been steady, major challenges remain.

**Table 5.4** LED Efficiencies

	LED efficiency in percent (Light energy out/electric energy in)				Effective phosphor conversion efficiency in percent		
	Blue	Green	Amber	Red		Green phosphor	Red phosphor
Current efficiency	55	22	8	44	Current efficiency	44	37
2025 goal	80	35	20	55	2025 goal	67	56

## Other Advanced Technologies

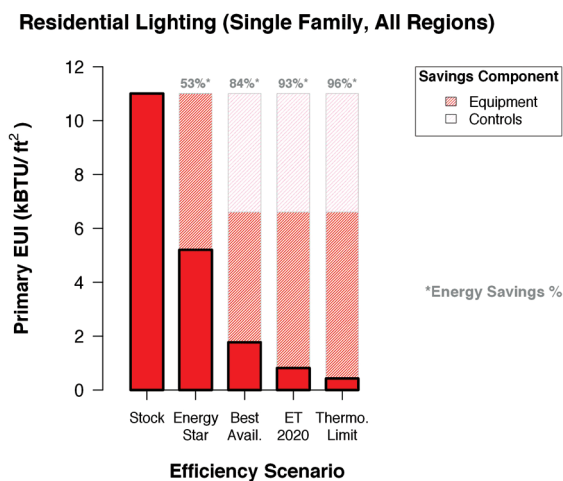
A variety of innovative strategies have been proposed for bringing natural light into interior spaces. They include the following:

- Internally reflective light conduits that bring light from roof collectors into interior spaces
- PV devices that are transparent to visible light but convert infrared and other portions of the sunlight into electricity (these devices may cut installation costs for self-powered window and window shading devices)
- Combined systems that generate electricity in rooftop PV units and transmit visible light through fiber optic systems to interior spaces

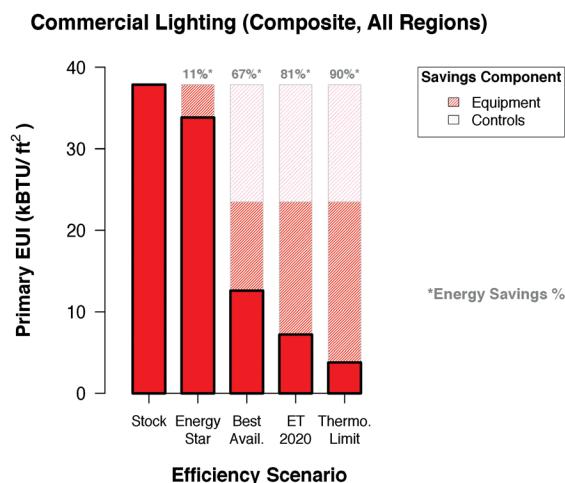
### 5.3.3 Integrated System Analysis

Taken together, use of efficient lighting devices, daylighting, sensors and controls, and good design can reduce the energy used for lighting by an order of magnitude. Potential savings from integrated systems is shown in Figure 5.14 and Figure 5.15. The order in which measures are considered shapes the magnitude of savings for subsequent measures. Least expensive measures were considered first, therefore sensors and controls were considered first.

**Figure 5.14** A combination of improved lighting devices and controls meeting 2020 program goals (ET) can reduce residential lighting energy 93% of the theoretical limit.



**Figure 5.15** A combination of improved lighting devices and controls meeting 2020 program goals (ET) can reduce commercial lighting energy 81% of the theoretical limit.



### 5.3.4 Research Opportunities

Innovators ranging from large global glass companies to small venture-supported firms are making significant investments in new window and window control systems. Federal research investment focused on devices should be limited to high-risk innovations such as novel optical materials and new manufacturing methods. There is a clear and continuing need for federal support of testing protocols for advanced glazing and fenestration systems, and the development of voluntary interoperability specifications for building controls that integrate and optimize dynamic envelope components, lighting, and HVAC. There is also a continuing role for the development of performance databases and simulation tools with open and validated algorithms and models. Detailed research priorities are laid out in recent roadmaps.<sup>78</sup>

One fundamental need is the development of test procedures for reliably determining the expected lifetime of commercial products. LEDs can last for decades but there are no data on long-lifetime units. A standard method for accelerated lifetime testing is essential.

Opportunities for fundamental research also include the following:

- Understanding why LED efficiency decreases at high power densities
- High-efficiency green LEDs
- Efficient quantum dot materials
- Glazing with tunable optical properties (also needed for thermal load management)
- Efficient, durable, low-cost OLEDs

Opportunities for reducing costs through improved design and manufacturing and other mechanisms include the following:

- Sensors and controls
- Lowering retrofit costs of new light fixtures

## 5.4 Major Energy Consuming Appliances: Hot Water Heaters, Refrigerators, and Clothes Dryers

Water heaters, refrigerators, and clothes dryers are major energy consumers and are responsible for about 18% of all building energy use. Many of the technologies designed to improve whole building energy performance discussed earlier can also be used to increase the efficiency of these appliances. For example, water heating efficiency can be improved using advanced heat pumps, low-cost variable-speed motors, thin insulation, and other improved designs. Improved insulation and other strategies can reduce the losses from lengthy hot water distribution systems in commercial buildings and large homes. Water heaters with storage tanks are good candidates for load shifting and providing other services important for optimizing electric utility performance with the help of improved controls and communications technologies. Work is often needed to ensure that these approaches are designed for the size ranges needed for appliances.

Significant gains have been made in refrigerator performance over the past decades but these gains have been partially offset by the increasing number of refrigerators and freezers used per household.<sup>79</sup> Improvement in heat pumps, advanced thermal cycles, heat exchangers, and thin, highly-insulating materials (e.g., vacuum insulation) can lead to major performance gains. Further gains are possible by using separate compressors optimized for freezers and refrigerator compartments and using variable speed drives and new sensors and controls to reflect ambient temperatures and react to signals from utilities.

Until recently, clothes dryers were untouched by the technical advances transforming markets for other building equipment, but this is changing rapidly. New clothes dryers now on the market use heat pumps to circulate heated air over clothing in a drum, pass the air over a heat exchanger cooled by the heat pump, condense the water out of the air, and then reheat and recycle the air. Since air is recycled, there is no need for an air vent. These appliances operate at lower temperatures (thus are gentler to clothes) and reduce utility peaks since their peak electric demands are one-fifth of conventional dryers.<sup>80</sup> The technology is attractive for designs that provide washing and drying in the same front-loading unit.<sup>80</sup>

U.S. sales have been limited because of their comparatively high cost and longer cycle times (typically double current times). American consumers, used to doing multiple loads of laundry, demand dryers that have roughly the same cycle time as washing machines. However, improved heat pumps, insulation, heat exchange, variable speed motors, and other innovations promise further gains in performance and lowered costs.<sup>81</sup> There are also



some potentially game-changing technologies on the horizon including the use of ultrasound to shake moisture out at ambient temperatures and technologies embedding thermoelectric heat pumps in the lining of the rotating drum.<sup>82</sup>

## 5.5 Electronics and Other Building Energy Loads

About 36% of building energy use is distributed across a wide range of systems, the majority of them electric. These include a variety of electronic devices such as computers, televisions, imaging equipment (e.g., printers and multifunction devices), audio/video equipment other than displays, telephony devices, and network equipment. Kitchen and household devices are also included, as are application-specific commercial building systems. Electric vehicle chargers are also included in this category. They are now small, but their importance may grow rapidly in coming years (see Chapter 8).

### 5.5.1 Computers and Other Electronic Devices

Computers and other electronic devices account for about 6% of all building energy use, and the U.S. Energy Information Administration forecasts that energy use in data center servers will increase five-fold by 2040, while energy use in other information technology equipment will more than double.<sup>83</sup> Table 5.5 contains additional information on the number of selected electronic devices in the United States and the total energy usage (in quads) associated with them.<sup>84</sup>

Federal research investments have played a major role in creating the fundamental innovations in devices and software that has driven the explosive growth of computers and other electronic equipment.<sup>85</sup> However, most applied research work has been supported by corporate research investments. This has driven both continuous improvements in the capabilities and cost reductions of computers, displays, communications devices (e.g., network equipment, telephony, and set-top boxes), imaging equipment (e.g., printers), and other audio/video equipment. There are still many opportunities for further improvement (see Table 5.6).

While most research has focused on improving product speed and quality, the large energy requirements of computational facilities have led to increased interest in improving energy efficiency and finding ways to reduce their peak power consumption.

Concern about the battery life of mobile devices and the huge energy use of modern data centers has driven major innovation in efficient chip

**Table 5.5** Computers and Electronic Devices

	Quads	Units (millions)
Residential	1.38	1363.3
<b>TV and related equipment</b>	<b>1.02</b>	<b>895.1</b>
TV	0.53	302.8
Set top boxes	0.39	327.1
Home theater	0.03	34.1
Video game consoles	0.02	60.1
DVD players	0.04	170.9
<b>PC and related equipment</b>	<b>0.36</b>	<b>468.2</b>
Monitors	0.07	84.1
Desktop PC	0.14	69.9
Network equipment	0.06	128.8
Laptops	0.10	185.3
Commercial	0.97	N/A
PC equipment	0.30	N/A
Non-PC equipment	0.67	N/A

**Table 5.6** Efficiencies of Electrical Devices

	Current stock (kWh/yr)	Best available (kWh/yr)	Max tech (kWh/yr)
TVs	213	63	24
Residential computers	158	34	N/A
Commercial computers	336	34	N/A
Set-top boxes	142	86	65

design.<sup>86</sup> Despite this, it is clear that society is far from the physical limits of energy efficient computing. Consider that a mouse brain can be 9,000 times faster than a personal computer simulation of its function, but the computer performing the simulation uses 40,000 times more power.

Research is beginning to make this “neural networking” approach to information processing available in practical devices, which can reduce computing energy use. Recently a number of groups have attempted to imitate the way biological brains process data.<sup>87</sup>

The best measure of merit for computational facilities would be based on the functions performed by the computers (e.g., data searched and images rendered) per unit of energy used. It would also provide a measure of inefficiencies owing to poorly written code or systems where servers are powered up but aren’t doing any work. These metrics are inherently specific to the particular type of computation or “workload” being performed; efforts to create a generic metric have thus far been unsuccessful.

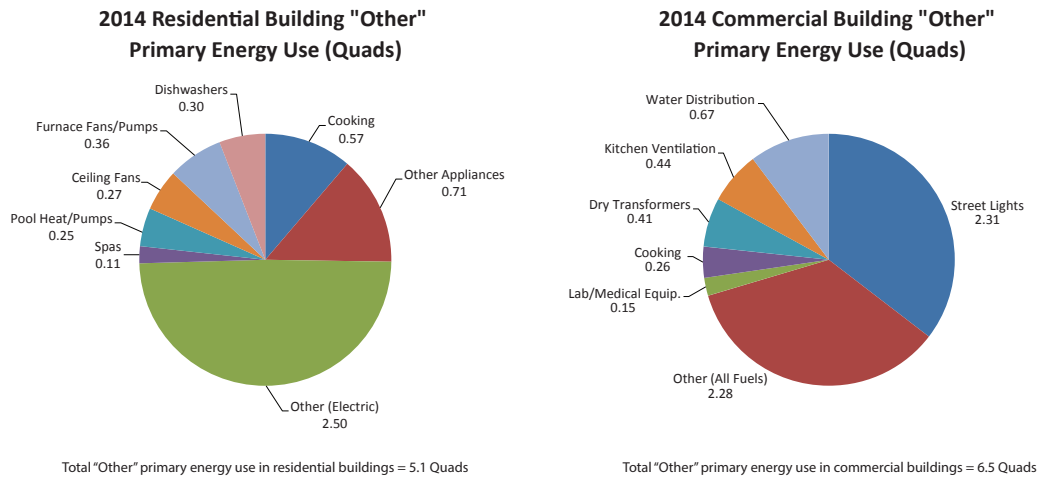
Buildings that house and cool large computer centers are also major energy consumers.<sup>88</sup> A commonly used measure of the efficiency of data centers is the power usage effectiveness (PUE). This is the ratio of the total energy used by the center to the energy used just by the computers. Older centers often used more energy for cooling than they did for the computers (i.e., PUE > 2). Better cooling designs have made it possible to greatly reduce this demand. The National Renewable Energy Laboratory’s recently completed center has a PUE of 1.06.<sup>89</sup> DOE and the U.S. Environmental Protection Agency have been active in encouraging much greater efficiency in these systems, and DOE recently partnered with a number of companies in a “data center challenge.”<sup>90</sup>

Computer screens, televisions, and other display devices can be major electricity users and the technology of these devices is changing very rapidly. Table 5.6 shows a large difference between the efficiency of the average televisions in use and the best available technologies.<sup>91</sup> This evolution has occurred even though new screens are often much larger and offer higher resolution and refresh rates than the ones they replace. Display technologies have rapidly become more energy efficient per unit of display area over the last decade. The increasing size, number, and hours of usage of displays are making this a topic of ongoing concern, and it increases the need for effective controls. The energy needed to operate network equipment was 20 terawatt-hours per year (TWh/year) in 2008 and continues to grow rapidly.<sup>92</sup>

### 5.5.2 Other Building Energy Loads

About 30% of all building energy consumption is not included in any of the technologies covered in earlier sections. Figure 5.16 shows that in the residential sector, the most prominent of these “other” building energy loads are cooking, household appliances, and various fans/pumps, while in the commercial sector the most prominent “other” loads come from non-building uses (e.g., street lighting, water distribution, etc.) and from kitchen ventilation and dry transformers.<sup>93</sup> It is notable that in both the residential and commercial sectors, a significant portion of the “other” loads remain unclassified with the unclassified portion limited to electric loads in the residential sector and stretching across all fuel types in the commercial sector.

**Figure 5.16** The “other” category of demand in buildings is created by a huge variety of devices—many of which are miscellaneous electric loads.



### 5.5.3 Research Opportunities

The diversity in these electronic and other building energy loads is so great that it has proven difficult to devise research strategies for addressing them; yet, the large amounts of energy they use becomes increasingly significant as other end uses become more energy efficient. An important part of the strategy will involve finding technologies that could address efficiency issues across a wide range of these miscellaneous end uses. Such technologies include more efficient circuitry, more flexible power management (though hardware and software solutions), and standardized communications protocols. Wide bandgap semiconductors (discussed in Chapter 6) can improve controls, and highly efficient motors, next-generation heat exchangers, and thin-insulation can improve the performance of a wide range of devices.

In the case of computers, basic research in materials, algorithms, and other work funded by the National Science Foundation, DOE’s Office of Science, and other federal agencies has been the foundation of this rapid growth. Building on this basic research foundation, the pace of change in the “computer and electronic products” industries has been extremely rapid because of high levels of commercial investment in innovation. This sector invested nearly 10% of their sales to research and development in 2007 in comparison to the national average of 3.8%.<sup>94</sup> While energy use has become a priority in areas like large server systems, where energy dissipation is becoming a barrier to progress, energy efficiency in a diverse set of other products is often neglected in the race to bring innovations to the market.

## 5.6 Systems-Level Opportunities

### 5.6.1 Sensors, Controls, and Networks

Lighting, windows, HVAC equipment, water heaters, and other building equipment are starting to be equipped with smart controllers and often wireless communications capabilities. These systems open many opportunities for improving building efficiency, managing peak loads, and providing services valuable to controlling the cost of large utility systems. They also offer many non-energy benefits that may be of greater interest to building owners and occupants than just energy usage. These include improved security, access control, fire and other emergency detection and management, and identification of maintenance issues before they lead to serious

problems. Low-cost sensors and controls also expand opportunities for individuals to have greater control of the thermal and lighting conditions, and if they power themselves using available light, vibrations, or fields generated by AC lines, it simplifies installation.

More than 40% of all commercial buildings more than 100,000 square feet had some kind of “energy management control” system but less than 7% of buildings smaller than 10,000 square feet used them in 2003.<sup>95</sup> Data on the type of controls and the way they are used (or misused) are very poor. A recent study of controls for packaged air units in California showed that 4.75% used manual controls while 35.7% employed a programmable thermostat.<sup>96</sup> Only 4% were part of an energy management system. Innovations that greatly lower the cost and simplify the installation and operation of control systems will be particularly valuable for expanding markets for advanced control systems in smaller commercial buildings and residences.

While individual subsystems such as lighting require their own control, the building as a whole will perform most efficiently if all the building systems are controlled as a part of an integrated system. Well-designed control systems can increase building efficiency up to 30% without the need to upgrade existing appliances.<sup>97</sup>

Figure 5.17 demonstrates the wide range of actors and interactions that characterizes the integrated building and grid system. Additional needs of the integrated electric grid are discussed in Chapter 3. Systems should be able to do the following:

- Control room temperatures, humidity, ventilation rates, tunable windows, variable louvers, and dimmable lights
- Control major appliances—most devices are controlled by turning them off or on, but the new generation of appliances allows more sophisticated adjustment of operation
- Use weather forecasts to develop optimum strategies for preheating or cooling the structure
- Detect and identify component failures and look for signs that equipment is about to fail
- Adapt performance in response to communications from utilities using new rate structures to minimize overall system costs
- Learn and anticipate user behaviors including adjusting for holidays and integrate user preferences dynamically

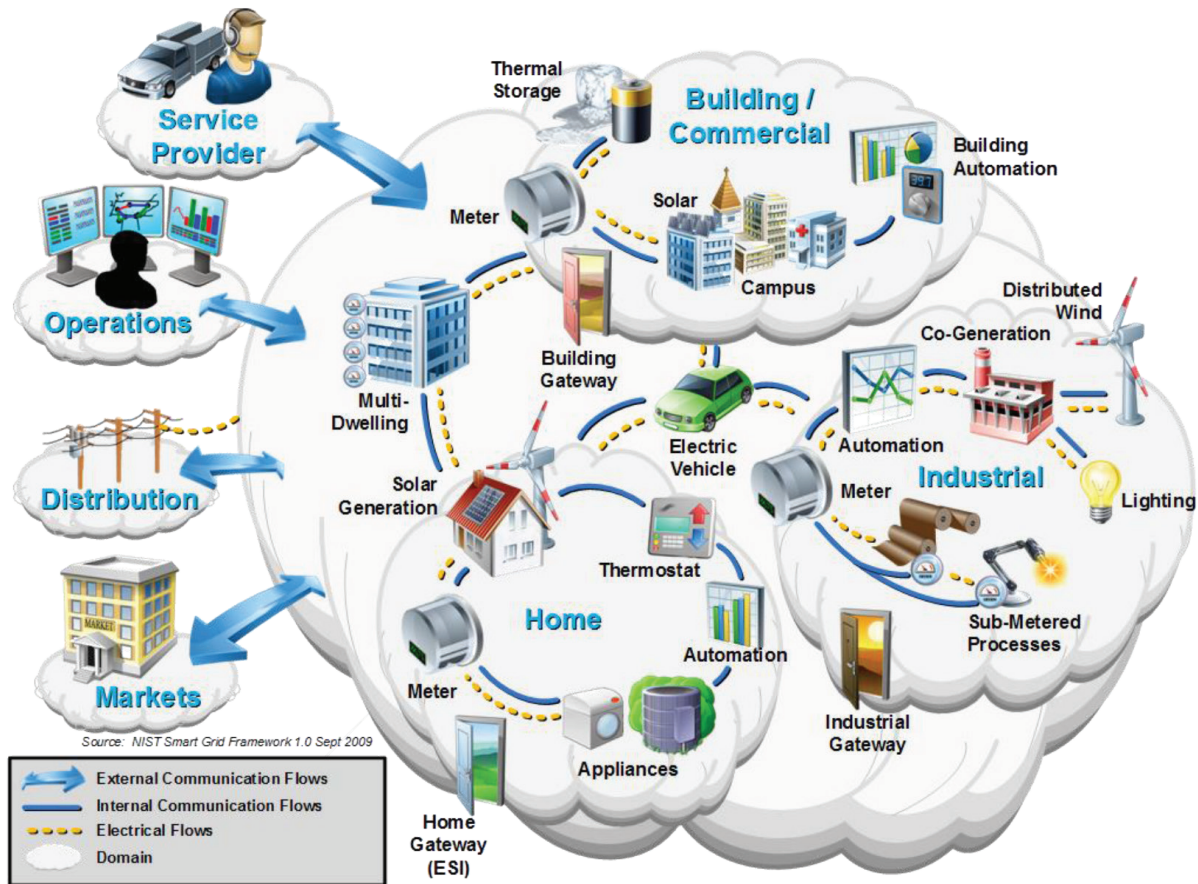
Cost has been a major barrier to the use of self-powered sensors and controls connected by wireless communication systems. Advances in designs and production technologies can cut the cost of lighting, temperature, occupancy, current, and other sensors from the \$150–\$300 per node to \$1–\$10 per node using printed electronic substrates for circuits, sensors, antennas, PVs, and batteries.<sup>98</sup>

Since buildings are responsible for more than 76% of all electric demand, control systems in buildings can also play a major role in optimizing the performance of the next-generation electric grid. Advanced building controls and control strategies can provide a portfolio of services ranging from helping maintain utility sixty-cycle frequency over periods of seconds, to short-term load shedding by controlling water heaters and other appliances, to longer-term load shifting using the thermal mass of the building or storage systems. PVs are rapidly entering the market in some regions, and the inverters that connect them to building loads and the electric grid can also provide services to the building and the electric grid.<sup>99</sup>

Control strategies can be designed for small grids internal to a building, micro-grids serving clusters of buildings, and large utility-scale “smart” grids. Benefits to the grid include improved frequency control, reduced spinning reserve, deferred expansion of transmission and distribution systems, and smoother reaction to unplanned outages. Early estimates suggest that intelligent building controls could potentially be worth \$59 billion (in 2009 dollars) annually in the United States by 2019.<sup>100</sup> These savings require major innovations in the financial incentives provided to customers for these services. Capturing these benefits requires building

**Figure 5.17** Future grid systems and smart building controls can communicate in ways that improve overall system efficiency and reliability.

Credit: National Institute of Standards and Technology



communications networks allowing the components to interoperate and respond to facility-wide control systems for both functionality and power distribution. Inverters connecting distributed PV systems can create problems if not effectively managed as a part of a grid system, but if properly managed, they, like other building control systems, can make significant contributions in the form of frequency regulation and in other areas.

Today, there is a lack of agreement on comprehensive communications and data standards. Competing, proprietary systems inhibit the widespread adoption of technologies and control strategies and drive up the cost of deployment. The absence of dynamic price incentives for customer grid services in most areas is a major barrier to development and commercialization of sophisticated systems.

Two major challenges in developing widely affordable building sensor and control systems include the high labor cost for retrofitting new lighting and lighting control systems and for getting complex control systems to work correctly. It takes many hours of expensive, highly-skilled system designer/operators to adjust schedules and ensure that building lighting and comfort levels actually reflect user needs.

There is growing concern that building communications systems need cybersecurity and privacy protection as an integral part of their design. Security concerns are particularly important in hospitals and other sites where life and safety are at risk.<sup>101</sup> Finding ways to update the software embedded in low cost devices is a new challenge.

## 5.6.2 Building Design and Operation

Well-designed buildings, systems, and control strategies can improve comfort levels, increase reliability, and reduce costs by optimizing use of component technologies. Often these low-energy buildings can be built with little or no extra cost. Advanced software that models buildings as integrated systems provides a powerful set of tools for ensuring effective building design and operations. These systems can predict building energy use given a description of its geometry, construction, systems, operations, occupancy, and local weather conditions. Whole-building energy modeling allows architects, engineers, and energy consultants to design a building's envelope, systems, and operation schemes to match its anticipated use profile and local conditions and to maximize energy-efficiency or return on investment while subject to constraints such as first cost. Innovations in the process of construction itself, such as greater use of modular components that could minimize air leaks and other problems associated with site-construction, might make this easier to accomplish.

A 2013 study of 1,112 design projects submitted to the American Institute of Architects 2030 Commitment program shows that buildings designed using energy modeling have a design energy consumption that is 44% lower than the 2003 stock. Buildings designed using prescriptive one-system-at-a-time rules outperform stock by only 29%.<sup>102</sup>

Unfortunately, only 55% of commercial building projects used modeling anywhere in the design process, including for either code compliance or green certification after the design had been finalized. However, thanks in part to DOE investments in the open-source modeling engine EnergyPlus and in the testing and long-term support for the validation of energy simulation engines, whole-building energy modeling has become more capable, robust, and consistent. DOE's open-source energy simulation software development platform OpenStudio is helping make energy modeling easier to use.<sup>103</sup> Nevertheless, more work remains to be done. Integrative design must also fit gracefully into existing relationships between owners, architects, engineers, and other stakeholders.

In addition to supporting system-level design, whole-building energy modeling can also be used to maintain, diagnose, and improve building energy performance during occupancy. Comparing modeled operations to actual operations supports detection and diagnosis of equipment and control faults, and, more generally, any divergences from design intent. Model-predictive control uses energy modeling, as well as real-time weather forecasts and (price) signals from the grid to tailor short-term control strategies for energy reduction, peak demand reduction, or other objectives—energy reductions of 15%–40% have been demonstrated.<sup>104</sup> Energy models can act as an intelligent interface for a building's on-site generation, energy storage, and thermal storage capabilities, and can be an integral part of systems that provide services to the utility grid.

Technical challenges and RDD&D opportunities for building energy modeling include the following:

- Continued improvements to open-source modeling tools to make them faster, more accurate, and easier to use while keeping up with emerging building technologies, especially in HVAC components, systems, and controls.
- Empirical validation and calibration of energy modeling engines including new strategies for benchmarking model results against large numbers of well-monitored buildings (facilitated by low cost sensors, controls, and communications capabilities). This will require measured information about temperature, equipment usage, occupancy, infiltration rates, and other critical variables. This could include a more detailed database of existing U.S. buildings than is possible with traditional survey methods. Interoperability standards are essential to convey data to and from the modeling system.<sup>105</sup>
- Use of the same control specification for energy simulation, control design, testing, and implementation. This unification would greatly streamline control design and eliminate interpretation and re-implementation errors.

- Development of system designs that minimize the risk of poor designs and installation and that detect and diagnose equipment faults. Models should be able to include estimates of stochastic behavior, uncertainty, and faults. Modeling should account for these conditions and provide ranges of expected outcomes given reasonable distributions of inputs.<sup>106</sup>
- Improved software for integrating smart distribution grids and advanced building controls.

### 5.6.3 Decision Science

The actual impact of new building technologies depends on how they are used by building occupants and operators, purchasing decisions, and many other factors that depend on aspects of human decision making. Building systems must be designed with the clearest possible understanding of user needs and preferences and the way they choose to interact with the technology.<sup>107</sup> Savings of five to nine quads per year appear possible.<sup>108</sup> Examples of areas where decision science and associated social and behavioral research can have a measurable impact include the following:

- The consumer “rebound effect” whereby efficiency investments lower the cost of energy services and thus could encourage wasteful behavior, (e.g., reduced incentives to turn out the lights).<sup>109</sup> Greater understanding of this effect would contribute to equipment and interface designs and forecasting.
- Many utilities are experimenting with approaches to customer communication that can actually influence their decisions and potentially have a lasting effect. These include strategies for helping consumers compare their energy use with their peers and neighbors and notifications that alert customers to anomalies that might need to be remedied. Modern communications and big-data analytics tools can personalize communication to provide clear and credible information when it’s most likely to be useful. Persistent savings of at least 3% and a peak demand reduction of 5% appear to be possible.<sup>110</sup>
- There are many examples of misuse or non-use of energy efficient equipment. As an example, less than 5% of housing units equipped with programmable thermostats use them properly.<sup>111</sup> Research to develop human interface designs that make controls transparent and easy to use is essential for capturing the potential of many technologies.
- There are several ways to provide information to consumers and users about their energy consumption. Well-designed energy labels can positively influence consumer decisions when they’re purchasing energy-intensive equipment, but care must be taken in their design.<sup>112</sup>
- The task of labeling increases as ET increase the complexity of purchasing decisions. Examples include: lighting devices that must be labeled for output in lumens rather than input in watts; lights with a wide range of color characteristics; and networking equipment with different kinds of communications, interoperability, cybersecurity, privacy, and other features.
- New technologies need to be introduced with consumer desires and needs clearly presented. When “smart” utility meters were initially introduced, there was often poor communication over the benefits and concerns. As a result, privacy and health concerns led to a backlash and low participation rates in some areas.
- Many energy-efficiency technologies that appear to be highly cost-effective have not found large markets. It’s important to understand how these markets operate to design effective programs to encourage more rapid adoption.

New information technologies open up opportunities to collect and evaluate large amounts of information at very low cost. This makes it possible to conduct statistically significant samples of different strategies for influencing consumer decisions. The federal government faces significant constraints in collecting this kind of information, but it could work on methodologies and analytical tools that facilitate research sponsored by utilities and others.

### 5.6.4 Embodied Energy

There is great variation in the energy needed to produce construction materials and build a structure (embodied energy). Analysis shows that this “embodied energy” is 5% of total building energy use for single-family residential building<sup>113</sup> and 16%–45% for office buildings.<sup>114</sup> NIST has recently introduced a powerful set of tools for evaluating the embodied energy of buildings.<sup>115</sup> The greatest potential for reducing the embodied energy of building materials involves strategies such as increasing recycling and the use of recycled materials, reducing process yield losses, substituting with less energy-intensive materials, and optimizing product design for minimal material use.

### 5.6.5 DC Systems

LED lights, computers, TVs and computer monitors, and many other modern devices operating in buildings now use relatively low-voltage DC instead of the AC available at wall plugs. The ubiquitous Universal Serial Bus connectors operate at five volts DC. PV devices and associated battery systems, as well as electric vehicles, operate on DC. Recent analysis suggests that a typical house using a PV system could reduce its electric demand by 14% if it was equipped with energy storage and 5% if there was no storage.<sup>116</sup> While AC to DC and DC to AC converters are becoming very efficient (typically greater than 90%) and are designed to go into hibernation modes when not in use, the large number of conversions leads to significant losses.

There may also be a growing market for distributed electrical storage to provide a variety of grid support services in future electric grid and microgrid systems. The best location and size of electric storage systems in any region will require a careful analysis of the value of increased reliability, economies of scale, diversity, and many other factors (see Chapter 3).

### 5.6.6 Thermal Energy Distribution and Reuse

Refrigeration equipment, clothes dryers, washing machines, and many other building energy systems generate heat that is typically dumped into the ambient air. It is clearly possible, however, to capture and circulate this heat so that it can be reused (possibly after its temperature is increased). Waste heat from refrigeration could be used to help heat hot water. Waste heat may also be available from combined heat and power systems and possibly from rooftop solar devices. In high-density areas, it might even be reasonable to share heat or cooling between buildings. The core of large buildings in most climates require air conditioning even in cold weather and improved strategies for moving heat from the core could contribute to system efficiency. Very little work has been done to explore low cost approaches to such energy sharing systems.

### 5.6.7 Research Opportunities

Many research topics exist covering a wide variety of areas. Among the priority areas are the following:

- Reducing the cost of sensors and controls for electrical current, temperature, CO<sub>2</sub> emissions and other airborne chemicals and materials, occupancy, and many others
- Developing energy harvesting systems to provide power for wireless sensors and controls
- Improving the design of sensor and control systems including cybersecurity and improved methods for installing and commissioning these systems
- Developing easy-to-use, fast, accurate software tools to design highly-efficient buildings and to assist operations
- Improving support for co-simulation with other modeling engines using a widely used interface standard
- Developing algorithms that allow building sensor and control systems to automatically optimize system performance without large inputs from skilled designers



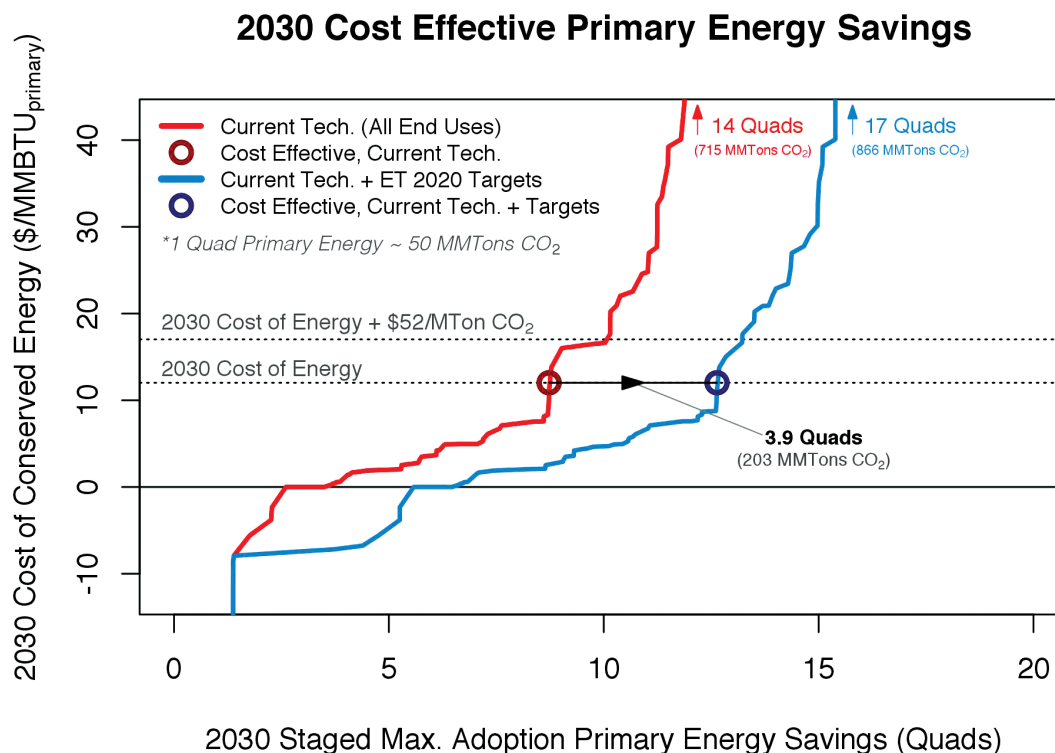
- Developing open-source software modules that can be combined to form sophisticated commercial control systems to enable flexible and dynamic buildings that provide value on both sides of the utility meter (DOE is encouraging the use of interoperable communications protocols for all building control and sensor systems and open-source system integration tools that will encourage creative commercial algorithms using both open-source and proprietary components.)
- Developing accurate, reliable sensors with low-installed costs, including occupancy sensors that can provide real-time occupancy counts
- Incorporating more decision science research while protecting the privacy of individuals and businesses
- Developing components and system designs that allow building devices to share waste heat

## 5.7 The Potential for Building Efficiency

Taken together, the technologies that can result from successful completion of the research topics discussed in this chapter have the potential to make significant reductions in building energy use at costs lower than forecast energy prices (Figure 5.18).<sup>117</sup> For reference, Figure 5.18 also shows energy prices that include the cost of GHG emissions now used to establish federal appliance standards; it is not intended to reflect a new analysis of the actual cost of these emissions.

In Figure 5.18, the red “Current Tech” curve shows the costs of efficiency measures now on the market. All the measures below the “2030 cost of energy” line—roughly nine quads—could be saved if all cost effective measures were purchased.<sup>118</sup> This would reduce building consumption by about 23%. If the 2020 goals described

**Figure 5.18** More than seven quads of energy could be saved in buildings by cost effective technologies by 2030. Meeting program goals would increase this by 3.9 quads. A carbon price would increase savings further.



earlier in this chapter for major technology categories are met, the cost-effective savings potential increases to nearly thirteen quads or about 34% of all building energy use. The additional four quads of energy savings represent an associated CO<sub>2</sub> emissions reduction of 203 million metric tons.<sup>119</sup>

This estimate is conservative for several reasons. For example, it does not address opportunities for reductions in miscellaneous electric loads that contribute significantly to building energy consumption. The analysis also doesn't place a value on increased amenities associated with an efficiency measure (such as increased comfort and safety), or on the ability of these measures to provide valuable services to electric grids (such as frequency regulation and load shifting). It is also highly likely that currently unknown innovations will lead to further cost reductions and performance improvements.

## 5.8 Conclusion

While there has been spectacular progress in building energy efficiency over the past few decades, it is clear that major opportunities remain. In many areas there are still large gaps separating the performance of commercial equipment and theoretical limits. In some cases our understanding of the nature of theoretical limits has changed because some novel mechanism has been discovered, such as membranes used to separate water from air or use of ultrasound to dry clothes. The limits have also changed because of better understanding of the way building technologies can take advantage of the external environment (e.g., daylighting and use of natural ventilation), and they should reflect the opportunity to reuse waste heat generated by building equipment. Reaching the potential will require ingenious product designs, advanced manufacturing methods that can lower costs and improve product quality, and advances in basic science—particularly in areas of materials science where novel approaches are needed on optical and thermal properties, magnetic materials, and on heat exchange and enthalpy exchange. The problems lead to a number of fundamental research challenges (see Table 5.7).

It is DOE's hope that this discussion effectively outlines the breadth, complexity, and importance of building energy technologies and help the nation's innovators understand where they can make critical contributions; those RDD&D opportunities presented in this chapter are summarized in Table 5.8.

**Table 5.7** Fundamental Research Challenges

- Materials with tunable optical properties (adjust transmissivity and absorptivity by wavelength)
- Materials for efficient LEDs
- Materials for efficient motors and controls (magnets and wide bandgap semiconductors)
- Enthalpy exchange materials
- Materials for low-cost krypton/xenon replacement
- Materials for non-vapor compression heat pumps (e.g., thermoelectric, magnetocaloric, and electrocaloric)
- Big-data management for large networks of building controls and next-generation grid systems
- Ultra-efficient computation (neural networks)
- Decision science research

**Table 5.8** Increasing Efficiency of Building Systems and Technologies

Area	RDD&D opportunities
Building thermal comfort and appliances	<ul style="list-style-type: none"> <li>■ Materials that facilitate deep retrofits of existing buildings (e.g., thin insulating materials)</li> <li>■ Low/no GWP heat pump systems</li> <li>■ Improved tools for diagnosing heat flows over the lifetime of a building</li> <li>■ Clear metrics for the performance of building shells in heat management and air flows</li> </ul>
Lighting	<ul style="list-style-type: none"> <li>■ Test procedures for reliably determining the expected lifetime of commercial LED and OLED products</li> <li>■ Understanding why LED efficiency decreases at high power densities</li> <li>■ High-efficiency green LEDs</li> <li>■ Efficient quantum dot materials</li> <li>■ Advanced sensors and controls for lighting</li> <li>■ Glazing with tunable optical properties (also needed for thermal load management)</li> <li>■ Efficient, durable, low-cost OLEDs</li> <li>■ Lower cost retrofit solutions for lighting fixtures</li> </ul>
Electronics and miscellaneous building energy loads	<ul style="list-style-type: none"> <li>■ More efficient circuitry (hardware and software)</li> <li>■ More flexible power management (hardware and software)</li> <li>■ Standardized communications protocols</li> <li>■ Wide-band-gap semiconductors for power supplies</li> </ul>
Systems-level opportunities	<ul style="list-style-type: none"> <li>■ Accurate, reliable, low installed cost sensors (including continuous occupancy sensors)</li> <li>■ Energy harvesting to power wireless sensors and controls</li> <li>■ Improved control systems (cybersecurity, install/commissioning)</li> <li>■ Control algorithms to automatically optimize building system performance</li> <li>■ Open source software modules supporting interoperability for commercial control systems</li> <li>■ Easy-to-use, fast, accurate software tools to design and operate highly efficient buildings</li> <li>■ Co-simulation modeling with a widely used interface standard</li> <li>■ Decision science research incorporating personal information security</li> <li>■ Components and systems that allow building devices to share waste heat</li> </ul>

## Supplemental Information

Building Energy Technology Roadmaps  
 Building Technologies Office Potential Energy Savings Analysis

[See online version.]

## Endnotes

- <sup>1</sup> Energy Information Administration (EIA). *Annual Energy Review 2014*. Washington, DC: U.S. Department of Energy, 2014. Available at: <http://www.eia.gov/forecasts/archive/aeo14/>. Note that total building energy use, as described here, includes residential and commercial energy use and also the similar HVAC and lighting energy use of industrial buildings. This changes the values presented slightly from those of chapter 1, which strictly separated residential and commercial building energy use from all industrial energy use.
- <sup>2</sup> Energy Information Administration (EIA). *Manufacturing Energy Consumption Survey 2010*. Washington DC: EIA, 2013. Because more recent data is not available, the figure assumes that the ratio of industrial electricity used for HVAC and lighting is the same as that found in the 2006 MECS survey.
- <sup>3</sup> This figure assumes that the price and performance goals described throughout this chapter are met and all cost-effective technologies are adopted. See the Appendix for detailed assumptions. A technology is assumed to be cost effective if the cost of saved energy (in dollars per million BTU or equivalent units) is lower than the cost of conventional energy (i.e., electricity or natural gas). The cost of saved energy is the discounted value of incremental costs divided by the discounted value of savings. A nominal discount rate of 6% is used. See Farese, P.; Gelman, R.; Robert, H. (2012). "A Tool to Prioritize Energy Efficiency Investments." Golden, CO: National Renewable Energy Laboratory (NREL), 2012. Available at: <http://www.nrel.gov/docs/fy12osti/54799.pdf>. The social cost of carbon and other externality costs are not included in this analysis.
- <sup>4</sup> Sawyer, K. "Windows and Building Envelope Research and Development: Roadmap for Emerging Technologies." DOE Building Technologies Office, 2014.
  - Goetzler, W.; Guernsey, M.; Young, J. "Research and Development Roadmap for Emerging HVAC Technologies." DOE Building Technologies Office, 2014. Available at: <http://energy.gov/sites/prod/files/2014/12/f19/Research%20and%20Development%20Roadmap%20for%20Emerging%20HVAC%20Technologies.pdf>.
  - "Solid-State Lighting Research and Development: Multi-Year Program Plan." DOE Building Technologies Office, 2014. Available at: [http://apps1.eere.energy.gov/buildings/publications/pdfs/ssl/ssl\\_mypp2013\\_web.pdf](http://apps1.eere.energy.gov/buildings/publications/pdfs/ssl/ssl_mypp2013_web.pdf).
  - U.S. Department of Energy, Office of Energy Efficiency and Renewable Energy. "Windows and Building Envelope Research and Development: Roadmap for Emerging Technologies." DOE Building Technologies Office, 2014. Available at: [http://energy.gov/sites/prod/files/2014/02/f8/BTO\\_windows\\_and\\_envelope\\_report\\_3.pdf](http://energy.gov/sites/prod/files/2014/02/f8/BTO_windows_and_envelope_report_3.pdf).
  - Goetzler, W.; Sutherland, T.; Foley, K. 2014, "Research & Development Roadmap for Next-Generation Appliances." DOE Building Technologies Office, 2014. Available at: <http://energy.gov/sites/prod/files/2014/12/f19/Research%20and%20Development%20Roadmap%20for%20Next-Generation%20Appliances.pdf>.
- <sup>5</sup> Reed, J. H. *Who Plays and Who Decides*. Washington, DC: ACEEE, 2004.
- <sup>6</sup> U.S. Department of Energy, Office of Energy Efficiency and Renewable Energy. *Windows and Buildings Envelope Research and Development*. Washington, DC, 2014. Available at: <http://energy.gov/eere/buildings/downloads/research-and-development-roadmap-windows-and-building-envelope>.
- <sup>7</sup> Ibid.
- <sup>8</sup> The insulating value is a measure of the rate at which heat passes through the window, typically specified by an R-value. A typical single-glazed window has an R-value of 1, but R-11 glazing materials and combined frame/glazing units with R-8.1 are commercially available. Zola European Windows. (n.d.). Zola European Windows: <http://www.zolawindows.com/>.
- <sup>9</sup> The "solar heat gain coefficient" is a measure of the fraction of total sunlight energy that can pass through the window, while the "visual transmittance" measures the fraction of visible sunlight that gets through. A typical single-glazed window has a solar heat gain coefficient and visual transmittance of about 0.7. Commercially available windows can come close to this, with a transmittance of 0.71 and a solar heat gain coefficient that can be selected in the range 0.29–0.62.
- <sup>10</sup> PPG Industries. *What is Low-E Glass?* Pittsburgh, PA: PPG Education Center, no date. Available at: [http://educationcenter.ppg.com/glassttopics/how\\_lowe\\_works.aspx](http://educationcenter.ppg.com/glassttopics/how_lowe_works.aspx).
- <sup>11</sup> EERE/DOE. *Buildings Energy Data Book*. Washington, DC: U.S. Department of Energy, 2011. Available at: <http://buildingsdatabook.eren.doe.gov/>.
- <sup>12</sup> Rissman, J.; Kennan, H. *Case Studies on the Government's Role in Energy Technology Innovation*. Washington, DC: American Energy Innovation Council, 2013.
- <sup>13</sup> Gasses such as argon, krypton, and xenon reduce heat convection and conduction relative to air. The thermal conductivity of argon is 67% that of air, and krypton is only 36% that of air. See PPG Glass Technology. "Gas Space Convection Effects on U-values in Insulation Glass Units." 2001. Available at: [http://buyat.ppg.com/glasstechlib/7\\_TD101E.pdf](http://buyat.ppg.com/glasstechlib/7_TD101E.pdf).
- <sup>14</sup> An R-value is a measure of insulating properties. The fiberglass in a standard 2 inch x 4 inch wood frame wall is about R-11. A single pane window is R-1.
- <sup>15</sup> Zola European Windows. (no date). *Zola European Windows*. Available at: <http://www.zolawindows.com/>.
- <sup>16</sup> Simpson, L. *Vacuum Insulation for Windows*. Golden, CO: National Renewable Energy Laboratory, 2014.
- <sup>17</sup> Betzendahl, R. "The 2014 Rare Gases Market Report." Lexington, MA: Cryogas International, 2014. Available at: [http://www.cryogas.com/pdf/Link\\_2014RareGasesMktReport\\_Betzendahl.pdf](http://www.cryogas.com/pdf/Link_2014RareGasesMktReport_Betzendahl.pdf).
- <sup>18</sup> Dow Corning Corporation. "Environmental Product Declaration: Vacuum Insulated Panels." Dow Corning Corporation, no date. Available at: [http://www.dowcorning.com/content/publishedlit/Dow\\_Corning\\_Vacuum\\_Insulation\\_Panels-EPD.pdf](http://www.dowcorning.com/content/publishedlit/Dow_Corning_Vacuum_Insulation_Panels-EPD.pdf).

- <sup>19</sup> Aspen Aerogel. “Highly Insulating Windows.” Northborough, MA: Aspen Aerogel, not date. Available at: <http://sites.energetics.com/buildingenvelope/pdfs/Aspen.pdf>.
- <sup>20</sup> Carver, R. “High Performance Insulation in Existing Multifamily Buildings: A Demonstration Project Using Aerogel Materials.” Albany, NY: New York State Energy Research and Development Authority, 2013. Available at: <http://www.nyserda.ny.gov/-/media/Files/Publications/Research/Other-Technical-Reports/high-performance-insulation.pdf>.
- <sup>21</sup> EERE/Department of Energy. *Windows and Buildings Envelope Research and Development*. Washington, DC: U.S. DOE, 2014.
- <sup>22</sup> Levinson, R. M.; Akbari, H. “Potential Benefits of Cool Roofs on Commercial Buildings: Conserving Energy, Saving Money, and Reducing Emission of Greenhouse Gases and Air Pollutants.” *Energy Efficiency* (3:1), 2010; pp. 53-109. Available at: <http://dx.doi.org/10.1007/s12053-008-9038-2>.
- Rosenfeld, A. H.; Akbari, H.; Romm, J. J.; Pomerantz, M. “Cool Communities: Strategies for Heat Island Mitigation and Smog Reduction.” *Energy and Buildings*, 1998; pp. 51-62. Available at: [http://dx.doi.org/10.1016/S0378-7788\(97\)00063-7](http://dx.doi.org/10.1016/S0378-7788(97)00063-7).
  - Bretz, S.; Akbari, H.; Rosenfeld, A. “Practical Issues for Using Solar-Reflective Materials to Mitigate Urban Heat Islands.” *Atmospheric Environment*, 1998; pp. 95-101. Available at: [http://dx.doi.org/10.1016/S1352-2310\(97\)00182-9](http://dx.doi.org/10.1016/S1352-2310(97)00182-9).
- <sup>23</sup> Raman, A. P.; Anoma, M. A.; Zhu, L.; Rephaeli, E.; Fan, S. “Passive Radiative Cooling Below Ambient Air Temperature Under Direct Sunlight.” *Nature*, 2014; pp. 540-544. Available at: <http://dx.doi.org/10.1038/nature13883>.
- <sup>24</sup> ASHRAE Standard 62, “Ventilation for Acceptable Indoor Air Quality,” sets minimum ventilation rates for different space use types and occupant densities.
- <sup>25</sup> Environmental Protection Agency. *Indoor Air Quality (IAQ)*. EPA, 2014.
- <sup>26</sup> ASHRAE. *Indoor Air Quality Guide: Best Practices for Design, Construction, and Commissioning*. Atlanta, GA: ASHRAE, 2009.
- Environmental Protection Agency (EPA). “Energy Savings Plus Health: Indoor Air Quality Guidelines for School Building Upgrades.” Washington, DC: EPA, 2014. Available at: [http://www.epa.gov/iaq/schools/pdfs/Energy\\_Savings\\_Plus\\_Health\\_Guideline.pdf](http://www.epa.gov/iaq/schools/pdfs/Energy_Savings_Plus_Health_Guideline.pdf).
- <sup>27</sup> Environmental Protection Agency (EPA). “IAQ Building Education and Assessment Model (I-BEAM).” Washington, DC: EPA, 2012. Available at: <http://www.epa.gov/iaq/largeblids/i-beam/index.html>.
- <sup>28</sup> EERE/Department of Energy. *Windows and Buildings Envelope Research and Development*. Washington, DC: U.S. DOE, 2014. U.S. DOE.
- <sup>29</sup> Stellberg, S. “Assessment of Energy Efficiency Achievable from Improved Compliance with U.S. Building Energy Codes: 2013–2030.” Washington, DC: Institute for Market Transformation, 2013. Available at: [http://www.imt.org/uploads/resources/files/IMT\\_Report\\_Code\\_Compliance\\_Savings\\_Potential\\_FINAL\\_2013-5-2.pdf](http://www.imt.org/uploads/resources/files/IMT_Report_Code_Compliance_Savings_Potential_FINAL_2013-5-2.pdf).
- <sup>30</sup> Muehleisen, R. “Acoustic Building Infiltration Measurement System.” Washington, DC: EERE/DOE, 2014. Available at: [http://energy.gov/sites/prod/files/2014/07/f17/emt40\\_Muehleisen\\_042414.pdf](http://energy.gov/sites/prod/files/2014/07/f17/emt40_Muehleisen_042414.pdf).
- <sup>31</sup> Lawrence Berkeley National Laboratory. “Aerosol Duct Sealing.” Berkeley, CA, 2014. Available at: <http://eetd.lbl.gov/l2m2/aerosol.html>.
- <sup>32</sup> Walker, A. “Natural Ventilation.” Washington, DC: National Institute of Building Sciences, 2014. Available at: <http://www.wbdg.org/resources/naturalventilation.php>.
- <sup>33</sup> Energy Design Resources. “Design Brief: Economizers.” Irwindale, CA: Energy Design Resources, 2011. Available at: [http://energydesignresources.com/media/2919091/edr\\_designbrief\\_economizers.pdf?tracked=true](http://energydesignresources.com/media/2919091/edr_designbrief_economizers.pdf?tracked=true).
- <sup>34</sup> Walker, I.; Sherman, M.; Les, B. “Houses Are Dumb Without Smart Ventilation. ACEEE Summer Study on Energy Efficiency in Buildings.” Washington DC: ACEEE, 2014. Available at: <http://aceee.org/files/proceedings/2014/data/papers/1-239.pdf>.
- <sup>35</sup> Domanski, P. A.; Henderson, H. I.; Payne, W. “Sensitivity Analysis of Installation Faults on Heat Pump Performance.” Washington, DC: NIST, Department of Commerce, 2014. Available at: <http://nvlpubs.nist.gov/nistpubs/TechnicalNotes/NIST.TN.1848.pdf>.
- <sup>36</sup> Department of Energy. “Energy Savings Potential and Opportunities for High-Efficiency Electric Motors in Residential and Commercial Equipment.” Washington, DC: U.S. Department of Energy, 2013. Available at: <http://energy.gov/sites/prod/files/2014/02/f8/Motor%20Energy%20Savings%20Potential%20Report%202013-12-4.pdf>.
- Dols, J.; Fortenbery, B.; Sweeney, M.; Sharp, F. “Efficient Motor-Driven Appliances Using Embedded Adjustable Speed Drives. ACEEE Summer Study on Energy Efficiency in Buildings.” Washington, DC: ACEEE, 2014. Available at: <http://aceee.org/files/proceedings/2014/data/papers/9-886.pdf>.
- <sup>37</sup> Energy Information Administration, DOE. “2003 Commercial Buildings Energy Consumption Survey 2003.” Washington, DC: DOE, 2006. Available at: <http://www.eia.gov/consumption/commercial/data/2003/>.
- <sup>38</sup> Energy Information Administration, DOE. “2003 Commercial Buildings Energy Consumption Survey 2003.” Washington, DC: DOE, 2006. Available at: <http://www.eia.gov/consumption/commercial/data/2003/>.
- <sup>39</sup> Bouza, A. “Policy Supporting Energy Efficiency and Heat Pump Technology.” Washington DC: EERE, 2012. Available at: <http://www.ornl.gov/sci/ees/etsd/btrc/usnt/04ABouza.pdf>.
- <sup>40</sup> The coefficient of performance is the ratio between the amount of energy moved (or “pumped”) by the heat pump to the amount of energy used by the machinery to do the pumping.

- <sup>41</sup> EERE/DOE. “High-Performance Commercial Cold Climate Heat Pump.” Washington, DC: DOE, 2014. Available at: <http://energy.gov/eere/buildings/downloads/high-performance-commercial-cold-climate-heat-pump>.
- <sup>42</sup> Bouza, A. *BTO’s Cold Climate Research Program*. Washington DC: EERE/DOE, 2014.
- <sup>43</sup> Goetzler, W.; Sutherland, T.; Rassi, M.; Burgos, J. “Research & Development Roadmap for Next-Generation Low Global Warming Potential Refrigerants.” Washington, DC: EERE/DOE, 2014. Available at: <http://www.energy.gov/sites/prod/files/2014/12/f19/Refrigerants%20Roadmap%20Final%20Report%202014.pdf>.
- <sup>44</sup> Energy Information Administration, DOE. “2003 Commercial Buildings Energy Consumption Survey 2003.” Washington, DC: DOE, 2006. Available at: <http://www.eia.gov/consumption/commercial/data/2003/>.
- <sup>45</sup> Department of Energy. “Energy Savings Potential and RD&D Opportunities for Non-Vapor-Compression HVAC Technologies.” Washington, DC: U.S. DOE, 2014. Available at: <http://energy.gov/sites/prod/files/2014/03/f12/Non-Vapor%20Compression%20HVAC%20Report.pdf>.
- Goetzler, W.; Sutherland, T.; Rassi, M.; Burgos, J. “Research & Development Roadmap for Next-Generation Low Global Warming Potential Refrigerants.” Washington, DC: EERE/DOE, 2014. Available at: <http://www.energy.gov/sites/prod/files/2014/12/f19/Refrigerants%20Roadmap%20Final%20Report%202014.pdf>.
  - Department of Energy, ARPA-e. “Building Energy Efficiency Through Innovative Thermodevices. No date. Available at: <http://arpa-e.energy.gov/?q=arpa-e-programs/beetit>.
  - Gluesenkamp, K. *CO<sub>2</sub> Heat Pump Water Heater*. Washington, DC: U.S. Department of Energy, 2014.
- <sup>46</sup> Xing, R.; Rao, Y.; Canfield, N.; Zhen, R.; DeGrootenhuys, W.; Winiarski, D.; et al. “Novel Zeolite Membrane for Energy Efficient Air Dehumidification and Conditioning.” *Chemical Engineering Science*, 2014; pp. 596-609.
- Bynum, J. D.; Claridge, D. E. “Thermodynamic Modeling of a Membrane Dehumidification System.” *Proceedings of System Simulation in Buildings 2014*. Liege, Belgium, 2014.
- <sup>47</sup> Kelly, J. “Low-Cost Microchannel Heat Exchanger.” U.S. DOE Advanced Manufacturing Office PEER Review Meeting. Washington, DC: DOE/EERE/AMO, 2014. Available in: <http://energy.gov/sites/prod/files/2014/06/f16/A2%20Poster-Altex%20AMO%20RD%20Project%20Peer%20Review%202014.pdf>.
- “HEATING UP” Oak Ridge National Laboratory. Accessed March 15, 2015: <http://www.ornl.gov/ornl/news/features/2015/heating-up>.
- <sup>48</sup> EERE/DOE. “Energy Department Invests \$14 Million in Innovative Building Efficiency Technologies.” 2014. Available at: <http://energy.gov/eere/articles/energy-department-invests-14-million-innovative-building-efficiency-technologies>.
- <sup>49</sup> Sandia National Laboratories. “RVCC Technology: A Pathway to Ultra-Efficient Air Conditioning, Heating, and Refrigeration.” Albuquerque, NM: Sandia National Laboratories, 2014. Available at: <http://energy.gov/eere/buildings/downloads/rotary-vapor-compression-cycle-technology-pathway-ultra-efficient-air>.
- <sup>50</sup> Zhou, D.; Zhao, C.; Tian, Y. (2012). “Review on Thermal Energy Storage with Phase Change Materials.” *Applied Energy*, 2012; pp. 593-605.
- <sup>51</sup> Pacific Northwest National Laboratory. “The Role of Energy Storage in Commercial Buildings: A Preliminary Report.” Richland, WA: Pacific Northwest National Laboratory, 2010. Available at: [http://www.pnnl.gov/main/publications/external/technical\\_reports/PNNL-19853.pdf](http://www.pnnl.gov/main/publications/external/technical_reports/PNNL-19853.pdf).
- <sup>52</sup> Abdelaziz, O.; Farese, P.; Abramson, A.; Phelan, P. “Technology Prioritization: Transforming the U.S. Building Stock to Embrace Energy Efficiency.” NSTI-Nanotech, 2013. Available at: <http://www1.eere.energy.gov/buildings/pdfs/technology-prioritization.pdf>.
- Each measure in the analysis is added to the baseline building, but energy savings depend on whether other measures are installed first. The analysis accounts for using the measures in different building types and climates as well as the fact that some measures do not work well as retrofits.
- <sup>53</sup> EERE/Department of Energy. *Windows and Buildings Envelope Research and Development*. Washington, DC: DOE, 2014.
- <sup>54</sup> Department of Energy. *Energy Savings Potential and RD&D Opportunities for Non-Vapor-Compression HVAC Technologies*. Washington, DC, 2014.
- <sup>55</sup> Boyce, P.; Hunte, C.; Howlett, O. “The Benefits of Daylight Through Windows. Washington, DC: U.S. DOE, 2003. Available at: <http://www.lrc.rpi.edu/programs/daylighting/pdf/DaylightBenefits.pdf>.
- <sup>56</sup> Stevens, R. G.; Brainard, G. C.; Blask, D. E.; Lockley, S. W.; Motta, M. E. “Adverse Effects of Nighttime Lighting: Comments on American Medical Association Policy Statement.” *American Journal of Preventive Medicine*, 2013; pp. 343-346. Available at: <http://dx.doi.org/10.1016/j.amepre.2013.04.011>.
- Brainarda, G. C.; Coylea, W.; Ayersa, M.; Kempa, J.; Warfielda, B.; Maidab, J.; et al. “Solid State Lighting for the International Space Station: Tests of Visual Performance and Melatonin Regulation.” *Acta Astronautica*, 2013; pp. 21-28. Available at: <http://dx.doi.org/10.1016/j.actaastro.2012.04.019>.
- <sup>57</sup> “2010 U.S. Lighting Market Characterization.” Washington, DC: Navigant Consulting, Inc., 2012. Available at: <http://apps1.eere.energy.gov/buildings/publications/pdfs/ssl/2010-lmc-final-jan-2012.pdf>.
- <sup>58</sup> Ibid.
- <sup>59</sup> Ibid.
- <sup>60</sup> “How Efficacious Are T8 Fluorescent Lamps?” Lighting Research Center, 2006. Available at: <http://www.lrc.rpi.edu/programs/NLPIP/lightingAnswers/t8/04-t8-efficacy.asp>.

- <sup>61</sup> International metrics are established by Commission Internationale de l'Éclairage (CIE). The National Energy Policy Act of 1992 (section 164) sets both efficiency standards and CRI standards (the minimum CRI required was between 45 and 69, depending on the type of bulb).
- <sup>62</sup> Rea, M.; Freyssinier, J. P. "Class A Color Classification for Light Sources Used for General Illumination." Troy, NY: Lighting Research Center, Rensselaer Polytechnic Institute, 2012. Available at: <http://www.lrc.rpi.edu/education/outreachEducation/pdf/CLE6/3-Rea.pdf>.
- <sup>63</sup> Dikel, E. E.; Burns, G. J.; Veich, J.; Mancini, S.; Newsham, G. R. "Preferred Chromaticity of Color-Tunable LED Lighting." *LEUKOS: The Journal of the Illuminating Engineering Society of North America*, 2014; pp. 101-115. Available at: <http://ies.tandfonline.com/doi/pdf/10.1080/15502724.2013.855614>.
- A commonly used index of color is the temperature of a glowing incandescent material in degrees Kelvin. This can range from 800 degrees (very red like glowing embers) to 12,000 degrees or more (very blue like skylight). Artificial devices that do not produce light like a glowing, heated object are matched to this scale by using a visual best-match called the "correlated color temperature" (CCT).
- <sup>64</sup> Cunningham, K.; Herbert, T. "Consumer Preference Survey on Directional LED Replacement Lamps for Retail Applications." San Francisco, CA: Pacific Gas and Electric Co, 2012. Available at: [http://cltc.ucdavis.edu/sites/default/files/files/publication/2012\\_ET11PGE2201\\_LED\\_Showcase\\_Report.pdf](http://cltc.ucdavis.edu/sites/default/files/files/publication/2012_ET11PGE2201_LED_Showcase_Report.pdf).
- <sup>65</sup> Chen, C.-C.; Dou, L.; Zuh, R.; Chung, C.-H.; Song, T.-B.; Bing, Z. Y. (2012). "Visibly Transparent Polymer Solar." *ASC Nano* (6:8), 2012.
- <sup>66</sup> GSA Public Building Service. "Thermochromic and Electrochromic windows." Washington, DC: GSA, 2014. Available at: <http://www.gsa.gov/portal/mediaId/188003/fileName/Smart-Windows-Findings-508.action>.
- <sup>67</sup> Arasteh, D.; Selkowitz, S.; Apte, J. "Zero Energy Windows. 2006 ACEEE Summer Study on Energy Efficiency." Pacific Grove, CA, 2006. Available at: [http://aceee.org/files/proceedings/2006/data/papers/SS06\\_Panel3\\_Paper01.pdf](http://aceee.org/files/proceedings/2006/data/papers/SS06_Panel3_Paper01.pdf).
- Klammt, S.; Neyer, A.; Muller, H. "Redirection of Sunlight by Microstructured Components—Simulation, Fabrication and Experimental Results." *Solar Energy*, 2012; pp. 1660-1666. Available at: <http://dx.doi.org/10.1016/j.solener.2012.02.034>.
- <sup>68</sup> Building Technologies Office, U.S. Department of Energy. *Windows and Building Envelope Research and Development*. Washington, DC: U.S. Department of Energy, 2014.
- Carmody, J.; Selkowitz, S.; Lee, E. S.; Arasteh, D. *Window Systems for High-Performance Buildings*. W.W. Norton & Company Inc.: New York, NY, 2004.
- <sup>69</sup> Ekwevugbe, T.; Brown, N.; Fan, D. "A Design Model for Building Occupancy Detection Using Sensor Fusion." *2012 6th IEEE International Conference on Digital Ecosystems and Technologies (DEST)*. IEEE, 2013.
- <sup>70</sup> Williams, A.; Atkinson, B.; Garbesi, K.; Rubenstein, F.; Page, E. *A Meta-Analysis of Energy Savings from Lighting Controls in Commercial Buildings*. Berkeley, CA: Lawrence Berkeley National Laboratory, 2011.
- <sup>71</sup> U.S. Department of Defense. "Advanced Lighting Controls for Reducing Energy Use and Cost in DOD Installations." Washington, DC: Environmental Security Technology Validation Program, U.S. Department of Defense, 2013. Available at: <https://www.serdp-estcp.org/Program-Areas/Energy-and-Water/Energy/Conservation-and-Efficiency/EW-201012>.
- <sup>72</sup> Schubert, E. F. *Light Emitting Diodes*. New York, New York: Cambridge University Press, 2006.
- <sup>73</sup> CREE. Cree First to Break 300 Lumens-Per-Watt Barrier. Raleigh, NC: CREE, 2014. Available at: <http://www.cree.com/News-and-Events/Cree-News/Press-Releases/2014/March/300LPW-LED-barrier>.
- <sup>74</sup> EERE/DOE. "Solid-State Lighting Research Multi-year Program Plan." Washington DC: DOE, 2014. Available at: [http://apps1.eere.energy.gov/buildings/publications/pdfs/ssl/ssl\\_mypp2014\\_web.pdf](http://apps1.eere.energy.gov/buildings/publications/pdfs/ssl/ssl_mypp2014_web.pdf).
- <sup>75</sup> EERE/DOE. "Solid-State Lighting Research and Development Research Roadmap." Washington DC: DOE, 2013. Available at: [http://apps1.eere.energy.gov/buildings/publications/pdfs/ssl/ssl\\_manuf-roadmap\\_august2012.pdf](http://apps1.eere.energy.gov/buildings/publications/pdfs/ssl/ssl_manuf-roadmap_august2012.pdf).
- <sup>76</sup> EERE/DOE. "Solid-State Lighting Research and Development Multi-year Program Plan." Washington, DC: DOE, 2014. Available at: [http://apps1.eere.energy.gov/buildings/publications/pdfs/ssl/ssl\\_mypp2014\\_web.pdf](http://apps1.eere.energy.gov/buildings/publications/pdfs/ssl/ssl_mypp2014_web.pdf).
- <sup>77</sup> Wood, V. B. "Colloidal Quantum Dot Light-Emitting." *Nano Reviews*, 2010; pp. 1-7.
- Lim, J. L.; Park, M.; Bae, W. K.; Lee, D.; Lee, S.; Lee, C.; et al. (2013). "Highly Efficient Cadmium-Free Quantum Dot Light-Emitting Diodes Enabled by the Direct Formation of Excitons Within InP@ZnSeS Quantum Dots." *ACS Nano*, 2013; pp. 9019-9026.
- <sup>78</sup> EERE/DOE. *Solid-State Lighting Research and Development Research Roadmap*. Washington, DC: DOE, 2013.
- EERE/DOE. *Solid-State Lighting Research Multi-year Program Plan*. Washington, DC: DOE, 2014.
- <sup>79</sup> EERE/DOE. "Refrigerator Standards Save Consumers \$ Billions." Washington, DC: DOE, 2013. Available at: <http://www.energy.gov/eere/buildings/articles/refrigerator-standards-save-consumers-billions>.
- <sup>80</sup> Environmental Protection Agency. "2014 Emerging Technology Award Winning Dryers." Washington, DC: EPA, 2014. Available at: [https://www.energystar.gov/sites/default/files/asset/document/2014%20Emerging%20Technology%20Award-winning%20Advanced%20Clothes%20Dryer%20Models\\_0.pdf](https://www.energystar.gov/sites/default/files/asset/document/2014%20Emerging%20Technology%20Award-winning%20Advanced%20Clothes%20Dryer%20Models_0.pdf).
- <sup>81</sup> Denkenberger, D.; Calwell, C.; Beck, N.; Trimboli, B.; Driscoll, D.; Wold, C. "Analysis of Potential Energy Savings from Heat Pump Clothes Dryers in North America." Washington, DC: CLASP, 2013. Available at: [http://www.clasponline.org/~media/Files/SLDocuments/2013/2013\\_Analysis-of-Potential-Energy-Savings-from-Heat-Pump-Clothes-Dryers-in-North-America.pdf](http://www.clasponline.org/~media/Files/SLDocuments/2013/2013_Analysis-of-Potential-Energy-Savings-from-Heat-Pump-Clothes-Dryers-in-North-America.pdf).

- <sup>82</sup> EERE/DOE. (2014). “Energy Department Invests \$14 Million in Innovative Building Efficiency Technologies.” Washington, DC: DOE, 2014. Available at: <http://energy.gov/eere/articles/energy-department-invests-14-million-innovative-building-efficiency-technologies>.
- <sup>83</sup> “Analysis and Representation of Miscellaneous Electric Loads in NEMS.” Washington, DC: U.S. Department of Energy, EIA, 2013. Available at: <http://www.eia.gov/analysis/studies/demand/miscelectric/pdf/miscelectric.pdf>.
- <sup>84</sup> EIA. *Annual Energy Review 2014*. Washington, DC: U.S. DOE, 2014.
- <sup>85</sup> “The Networking and Information Technology Research and Development (NITRD) Program 2012 Strategic Plan.” Washington, DC: National Science and Technology Council, 2012. Available at: [https://www.nitrd.gov/PU.S.strategic\\_plans/2012\\_NITRD\\_Strategic\\_Plan.pdf](https://www.nitrd.gov/PU.S.strategic_plans/2012_NITRD_Strategic_Plan.pdf).
- <sup>86</sup> “AMD Accelerates Energy Efficiency of APUs, Details Plans to Deliver 25x Efficiency Gains by 2020.” AMD Corporation, 2014. Available at: <http://www.amd.com/en-us/press-releases/Pages/amd-accelerates-energy-2014jun19.aspx>.
- <sup>87</sup> Merolla, P.; Arthur, J.; Alvarez-Lcaza, R.; et al. (2014). “A Million Spiking-Neuron Integrated Circuit with a Scalable Communication Network and Interface.” *Science*, 2014; pp. 614-616.
- Abate, T.; Adams, A. “Stanford Bioengineers Create Circuit Board Modeled on the Human Brain.” *Stanford News*, no date. Available at: <http://news.stanford.edu/pr/2014/pr-neurogrid-boahen-engineering-042814.html>.
  - In spite of this efficiency, energy used in information processing remains a challenge for biological systems. The human brain, for example, is only about 2% of the body’s weight but uses about 20% of the body’s energy. (Harmon, 2009).
- <sup>88</sup> Khattar, M. “Energy Efficiency in Data Centers.” Climate Leaders Meeting. Boulder, CO, 2007.
- Tschudi, W.; Xu, T.; Dale, S. (2003). “High Performance Data Centers: A Research Roadmap.” Berkeley, CA: Lawrence Berkeley National Laboratory, 2003. Available at: <http://escholarship.org/uc/item/0w64r459>.
- <sup>89</sup> NREL. “NREL’s ESIF Data Center.” Golden, CO: National Renewable Energy Laboratory, 2013. Available at: <https://hpc.nrel.gov/datacenter>.
- <sup>90</sup> “Private Companies, Federal Agencies and National Labs Join Better Buildings Challenge to Drive Greater Efficiency in U.S. Data Centers.” DOE, 2014. Available at: <http://www.energy.gov/articles/private-companies-federal-agencies-and-national-labs-join-better-buildings-challenge-drive>.
- <sup>91</sup> Amann, J.; Kwatra, S. “Program and Policy Strategies for Tackling Miscellaneous Energy Loads.” 2014 ACEEE Summer Study on Energy Efficient Buildings. Washington, DC: ACEEE, 2014. Available at: <http://aceee.org/files/proceedings/2014/data/papers/9-916.pdf>.
- <sup>92</sup> Lanzisera, S.; Nordman, B.; Brown, R. “Data Network Equipment Energy Use and Savings Potential in Buildings.” *Energy Efficiency*, 2012; pp. 149-162.
- <sup>93</sup> EIA. *Annual Energy Review 2014*. Washington, DC: U.S. DOE, 2014.
- <sup>94</sup> National Science Foundation. “Industrial Research and Development Information System.” Washington, DC, no date. Accessed January 15, 2015: [http://www.nsf.gov/statistics/iris/history\\_data.cfm](http://www.nsf.gov/statistics/iris/history_data.cfm).
- <sup>95</sup> Energy Information Administration, DOE. *2003 Commercial Buildings Energy Consumption Survey*. Washington, DC: DOE, 2006.
- <sup>96</sup> Itron, Inc. “California End Use Survey.” Folsom, CA: California Energy Commission, 2006. Available at: <http://www.energy.ca.gov/2006publications/CEC-400-2006-005/CEC-400-2006-005.PDF>.
- <sup>97</sup> TIAX, LLC. “Energy Impact of Commercial Building Controls and Performance Diagnostics: Market Characterization, Energy Impact of Building Faults and Energy Savings Potential.” NTIS PB2006-100567, 2005. Available at: [http://s3.amazonaws.com/zanran\\_storage/www.tiaxllc.com/ContentPages/42428345.pdf](http://s3.amazonaws.com/zanran_storage/www.tiaxllc.com/ContentPages/42428345.pdf).
- <sup>98</sup> Kuruganti, T.; Joshi, P.; Killough, S.; Li, J.; Noh, J.; Olama, M.; et al. *Low-cost, Self-powered Wireless Sensors for Building Monitoring Applications*. Oak Ridge, TN: Oak Ridge National Laboratory, 2014.
- <sup>99</sup> Pacific Gas and Electric. “Recommendations for Updating the Technical Requirements for Inverters in Distributed Energy Resources.” San Francisco, CA: California PUC, 2014. Available at: [http://www.energy.ca.gov/electricity\\_analysis/rule21/documents/recommendations\\_and\\_test\\_plan\\_documents/Recommendations\\_for Updating\\_Technical\\_Requirements\\_for\\_Inverters\\_in\\_DER\\_2014-02-07-CPUC.pdf](http://www.energy.ca.gov/electricity_analysis/rule21/documents/recommendations_and_test_plan_documents/Recommendations_for Updating_Technical_Requirements_for_Inverters_in_DER_2014-02-07-CPUC.pdf).
- <sup>100</sup> Booth, A.; Greene, M.; Tai, H. (2014). “US Smart Grid Value at Stake: the \$130 Billion Question.” New York, NY: McKinsey & Co., 2014. Available at: [http://www.mckinsey.com/~/media/mckinsey/dotcom/client\\_service/EPNG/PDFs/McK%20on%20smart%20grids/MoSG\\_130billionQuestion\\_VE.aspx](http://www.mckinsey.com/~/media/mckinsey/dotcom/client_service/EPNG/PDFs/McK%20on%20smart%20grids/MoSG_130billionQuestion_VE.aspx).
- <sup>101</sup> Chipley, M. “Cybersecurity.” Washington, DC: National Institute for Building Sciences, 2014. Available at: <http://www.wbdg.org/resources/cybersecurity.php>.
- <sup>102</sup> Pickard, K. “Commitment: Measuring Industry Progress Toward 2030.” Washington, DC: American Institute of Architects, 2013. Available at: <http://www.aia.org/aiaucmp/groups/aia/documents/pdf/aiab100374.pdf>.
- <sup>103</sup> Guglielmetti, R.; Macumber, D.; Long, N. *OpenStudio: An Open Source Integrated Analysis Platform. Building Simulation*. Sydney, Australia, 2011.
- <sup>104</sup> Oldewurtel, F.; Parisio, A.; Jones, C.; Morari, M.; Gyalistras, D.; Gwerder, M.; et al. “Use of Model Predictive Control and Weather Forecasts for Energy Efficient Building Climate Control.” *Energy and Buildings*, 2012; pp. 15-27.
- <sup>105</sup> Buildings Technology Office, U.S. Department of Energy. “Technical Meeting on Data/Communication Standards and Interoperability of Building Appliances, Equipment, and Systems.” Available at: <http://energy.gov/eere/buildings/downloads/technical-meeting-datacommunication-standards-and-interoperability-building>.



- <sup>106</sup> Muehleisen, R.; Heo, Y.; Graziano, D.; Guzowski, L. "Stochastic Energy Simulation for Risk Analysis of Energy Retrofits." *Architecture Engineering National Conference*, 2013; pp. 902-911.
- <sup>107</sup> Sovacool, B. K. "What Are We Doing Here? Analyzing Fifteen Years of Energy Scholarship and Proposing a Social Science Research Agenda." *Energy Research and Social Science*, 2014; pp. 1-29.
- Lutzenhiser, L. H. "Lifestyles, Buildings and Technologies: What Matters Most?" 2012 ACEEE Summer Study on Energy Efficiency in Buildings. Asilomar, CA: ACEEE, 2012. Available at: <http://aceee.org/files/proceedings/2012/data/papers/0193-000034.pdf>.
  - Stern, P. "Individual and Household Interactions with Energy Systems: Toward Integrated Understanding." *Energy Research and Social Science*, 2014; pp. 41-48.
- <sup>108</sup> Gardner, G.; Stern, P. "The Short List: The Most Effective Actions U.S. Households Can Take to Curb Climate Change." *Environment*, 2008.
- Saitner, J.; Ehrhardt-Martenez, K.; McKinney, V. "Examining the Scale of the Behavior Energy Efficiency Continuum." *ECEEE 2009 Summer Study: Act! Innovate! Deliver! Reducing Energy Demand Sustainably*. La Colle sur Loup, France: European Council for an Energy-Efficient Economy, 2009. Available at: <http://aceee.org/files/pdf/presentation/SKP-KEM-Behaviour-Energy-Efficiency-Continuum-Oct-5-2009.pdf>.
- <sup>109</sup> Gillingham, K. K. "The Rebound Effect Is Over-played." *Nature*, 2013; pp. 475-476.
- <sup>110</sup> Opower. "Transform Every Customer into a Demand Resource: How Utilities Can Unlock the Full Potential of Residential Demand Response." Arlington, VA: Opower, 2014. Available at: [http://opower.com/uploads/library/file/85/TurnEveryCustomerIntoADemandResponseResource\\_\\_8\\_\\_1\\_.pdf](http://opower.com/uploads/library/file/85/TurnEveryCustomerIntoADemandResponseResource__8__1_.pdf).
- <sup>111</sup> Sachs, O.; Tiefenbeck, V.; Duvier, C.; Qin, A.; Cheney, A.; Akers, C.; et al. "Field Evaluation of Programmable Thermostats." Washington, DC: DOE/BTO, 2012. Available at: [http://apps1.eere.energy.gov/buildings/publications/pdfs/building\\_america/field\\_eval\\_thermostats.pdf%20](http://apps1.eere.energy.gov/buildings/publications/pdfs/building_america/field_eval_thermostats.pdf%20).
- <sup>112</sup> Newel, R. G.; Siikamäki, J. "Nudging Energy Efficiency Behavior: The Role of Information Labels." Washington, DC: Resources for the Future, 2013. Available at: <http://www.rff.org/Publications/Pages/PublicationDetails.aspx?PublicationID=22220>.
- <sup>113</sup> Marceau, M. L.; VanGeem, M. G. *Comparison of the Life Cycle Assessments of an Insulating Concrete Form House and a Wood Frame House*. Skokie, Illinois: Portland Cement Association, 2008.
- <sup>114</sup> Junnila, S.; Horvath, A.; Guggemos, A. "Life-cycle Assessment of Office Buildings in Europe and the U.S." *Journal of Infrastructure Systems*, 2006; pp. 10-17.
- Thormark, C. "A Low Energy Building in a Life Cycle—Its Embodied Energy, Energy Need for Operation and Recycling Potential." *Building and Environment*, 2002; pp. 429-435.
- <sup>115</sup> NIST. "BIRDS Is for Sustainability: New NIST Tool for Evaluating Building Performance, Trade-offs." Washington, DC: Department of Commerce, NIST, 2014. Available at: <http://birdscom.nist.gov/>.
- <sup>116</sup> Vossos, V.; Garbesi, K.; Shen, H. "Energy Savings from Direct-DC in U.S. Residential Buildings." *Energy in Buildings*, 2014; pp. 223-231.
- <sup>117</sup> This figure shows the cost of saved energy by using a 7% discount rate. The "2030 Cost of Energy" is the EIA Annual Energy Outlook 2014 reference case forecast of electricity and gas prices delivered to buildings combined by weighting the prices to reflect building energy use. Note that total savings potential is not the sum of potential savings of each measure because some of the technologies will compete for the same market and the size of the market may be reduced by other measures (e.g., heating demand will be cut by well-insulated walls and windows).
- <sup>118</sup> For a description of how the analysis reflects assumptions about new construction, retrofits, and upgrades, see Farese, P.; Gelman, R.; Robert, H. *A Tool to Prioritize Energy Efficiency Investments*. Golden, CO: NREL, 2012.
- <sup>119</sup> CO<sub>2</sub> intensities were derived by fuel type using energy-related CO<sub>2</sub> emissions data from the EIA Annual Energy Outlook 2010 summary tables.



## Issues and RDD&D Opportunities

- Manufacturing affects the way products are designed, fabricated, used, and disposed; hence, manufacturing technologies have energy impacts extending beyond the industrial sector.
- Life-cycle analysis is essential to assess the total energy impact of a manufactured product.
- State-of-the-art technologies available today could provide energy savings, but many have not yet penetrated the market due to barriers such as high capital intensity and lack of knowledge. Opportunities exist to overcome these barriers and increase technology uptake.
- Transformative manufacturing processes, materials, and technologies can provide advantages over the practices widely in use, and in many cases enable the fabrication of innovative new clean energy products.
- Industrial-scale energy systems integration technologies, such as waste heat recovery and distributed energy generation, can reduce the manufacturing sector's reliance on the electric grid and increase industrial efficiency.
- Data, sensors, and models can improve design cycles and enable real-time management of energy, productivity and costs, increasing manufacturing efficiency while improving product quality and throughput.

The chapter can help address these important questions:

- What manufacturing research and development opportunities can be developed to drive down energy intensity, carbon intensity, and use intensity?
- What innovative manufacturing technology and system improvements and innovations might result in the greatest economy-wide impacts?
- What is the appropriate balance between maturation of existing technologies and development of advanced, next-generation technologies?

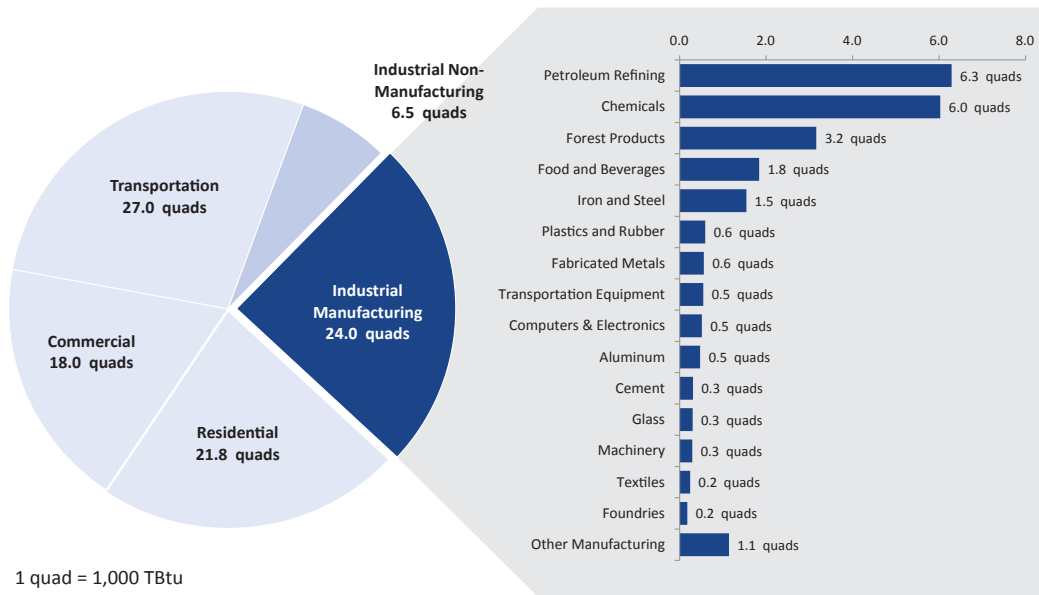
# 6

## Innovating Clean Energy Technologies in Advanced Manufacturing

### 6.1 Introduction

Clean energy manufacturing involves the minimization of the energy and environmental impacts of the production, use, and disposal of manufactured goods, which range from fundamental commodities such as metals and chemicals to sophisticated final-use products such as automobiles and wind turbine blades. The manufacturing sector, a subset of the industrial sector, consumes 24 quads of primary energy annually in the United States—about 79% of total industrial energy use, as shown in Figure 6.1.<sup>1</sup> Clean energy manufacturing can improve energy utilization and also yield economy-wide reductions in greenhouse gas (GHG) emissions through changes in energy use enabled by the development of new materials and process technologies.

**Figure 6.1** Manufacturing Share of the Nation’s Overall Energy Consumption and Breakdown of Manufacturing Primary Energy (including non-fuel feedstock energy) Consumption by Subsector (2010)<sup>2</sup>



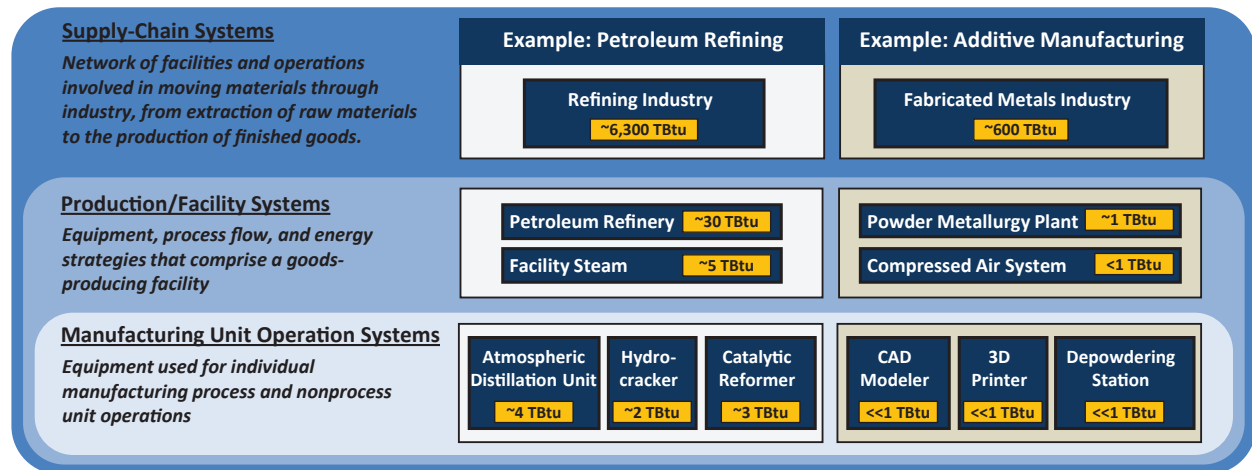
Key: **Btu** = British thermal unit; **TBtu** = trillion Btu

This chapter examines the opportunities for improvements in energy and materials utilization within three spaces:

- Individual manufacturing processes and unit operations
- Goods-producing facilities, including manufacturing business processes
- Manufacturing supply chains and manufactured goods, including impacts from all phases of the product life cycle

These opportunities correspond to three levels of manufacturing system integration: manufacturing/unit operations, production/facility systems, and supply chain systems, as illustrated in Figure 6.2. Specific objectives within each opportunity area were used to identify key technologies of interest for a balanced research, development, demonstration, and deployment (RDD&D) portfolio. These technologies were analyzed in a series of fourteen manufacturing Technology Assessments (available as appendices to this report). The Technology Assessments were informed by detailed analyses, roadmaps, and other studies that principally addressed energy impacts, but also considered other impacts as appropriate. While this report treats each manufacturing technology individually, it is important to note that the technologies are inherently interconnected, as illustrated in Figure 6.3. Each technology impacts many other technologies inside and outside of the manufacturing sphere. Some technologies may rely on similar RDD&D, and platform technologies such as automation affect manufacturing systems broadly, while other technologies can be used in combination and complement each other. Further, most technologies have impacts at every systems level—not just at a single level. This chapter organizes technologies based on the characteristics of the technology and its key energy savings opportunities, but important opportunities at all systems levels are explored.

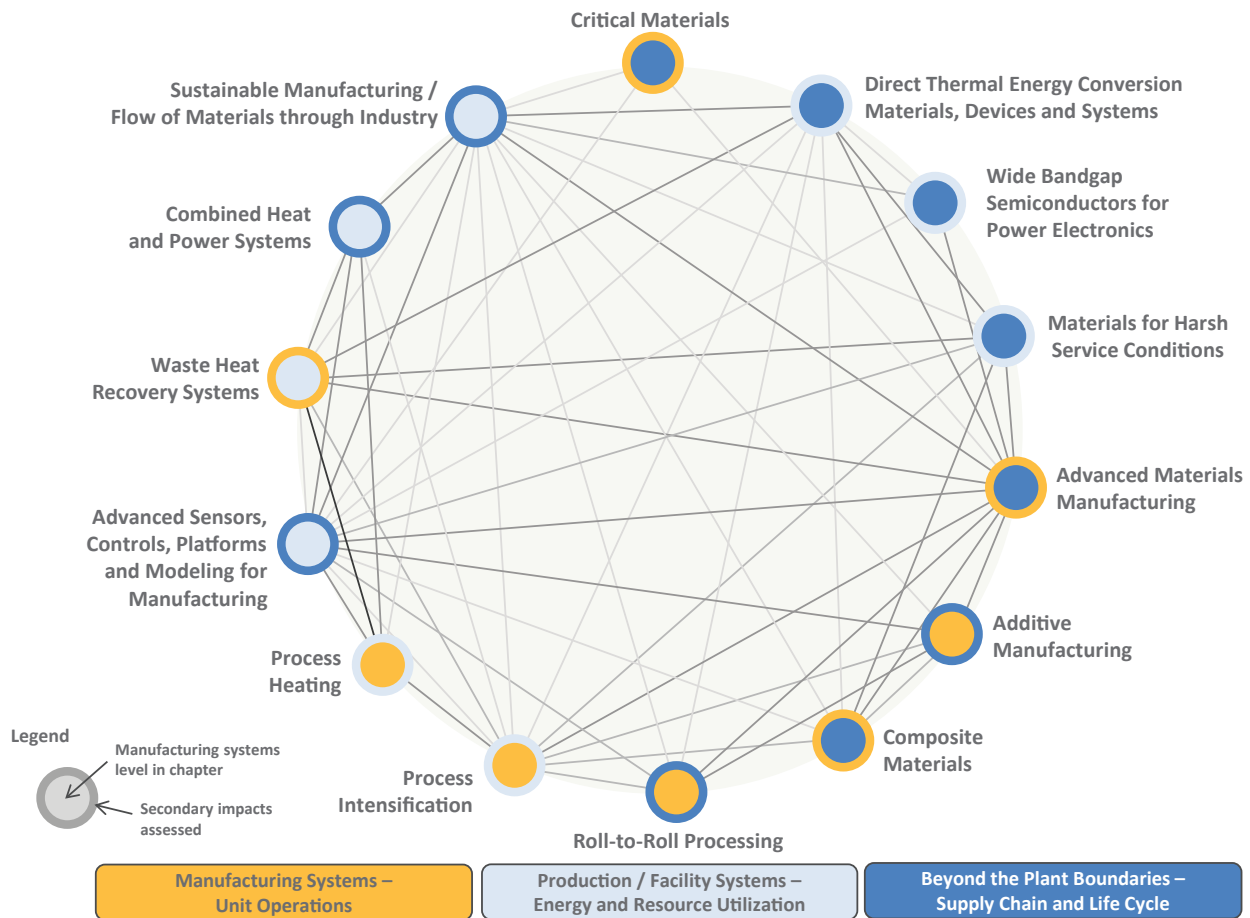
**Figure 6.2** Levels of System Integration in Manufacturing. Opportunities for energy savings occur at each system level. The energy usage estimates shown (yellow boxes) represent the typical annual energy consumption levels in the United States for a single industry, production facility, or piece of manufacturing equipment.



### 6.1.1 Energy Opportunity Space: Manufacturing Systems – Unit Operations

A wide array of process technologies and manufacturing operations is used to convert raw materials to finished products, often through long sequences of intermediate product forms. These can be defined as unit operations. At this unit operation level, key energy opportunities include advanced equipment that enhances throughput, lessens environmental impacts, reduces wasted energy, and achieves higher energy efficiencies than existing processes. The energy consumption required for each process step is governed by the efficiency of the best-

**Figure 6.3** Constellation Diagram Showing Connections Between the Fourteen Manufacturing Technologies Analyzed in Technology Assessments. QTR Technology Assessments investigate current technology status, RDD&D needs, and potential energy impacts.



available manufacturing equipment and the underlying process physics of the manufacturing operation. Further, process step elimination, process step substitution, equipment co-location, and other process integration strategies can further reduce manufacturing energy demands. These opportunities are explored in Section 6.2.

### 6.1.2 Energy Opportunity Space: Manufacturing Equipment Clusters and Facility Systems – Energy and Resource Utilization

The facility-level energy opportunity space includes technologies for effectively managing the use and flows of energy and materials at manufacturing facilities. Manufacturing facilities integrate manufacturing equipment and practices into complex workflows to transform raw materials into finished goods. Advanced technologies for onsite energy generation to supplement delivered energy, energy conversion, waste heat recovery and re-use, materials handling, and real-time energy consumption adjustments can improve the efficiencies of these facilities. The rise of information technologies in the manufacturing sector, for example, has enabled many next-generation technologies to leverage the use of data, machine- and plant-level monitoring and control strategies, robotics, and automation to manage and optimize energy use and flows in real time. Opportunities to improve energy and resource utilization at the facility level are analyzed in Section 6.3.

### 6.1.3 Energy Opportunity Space: Manufacturing Supply Chains and Life-Cycle Impacts of Manufactured Goods

The third energy opportunity space involves innovative new materials and new manufacturing technologies for products that impact supply chains and reduce life-cycle energy usage. The life cycle of a product incorporates all phases of its production and use, from resource extraction to end-of-life disposal or recycling. Energy consumption and environmental impacts in all phases of the life cycle contribute to its total energy intensity, use intensity, and carbon intensity. Manufacturing supply chains and products reach all end-use sectors and affect all parts of the energy economy. Process heating equipment; steam turbines; commercial heating, ventilating, and air conditioning (HVAC) systems; home appliances; and vehicles are all examples of manufactured goods. The life-cycle energy consumption associated with these goods drives energy use in the industrial, power generation, commercial buildings, residential buildings, and transportation sectors, respectively. Reducing these energy impacts often requires new types of materials, such as lighter-weight materials for vehicles or high-temperature superalloys for ultra-supercritical steam turbines, and new manufacturing approaches to enable the production of those goods. These opportunities are discussed in Section 6.4.

### 6.1.4 Foundation for a Technology Portfolio Structure

An effective technology RDD&D portfolio must balance between high-efficiency manufacturing equipment and approaches (Section 6.2), advanced technologies to improve energy and resource use at manufacturing facilities (Section 6.3), and next-generation products with potential for energy impacts throughout the economy (Section 6.4). The portfolio must also include a mixture of developmental timescales, including both short-term projects and longer-term projects that push technological boundaries or involve transformational new approaches.

Over-arching goals for consideration by decision makers could include the following:

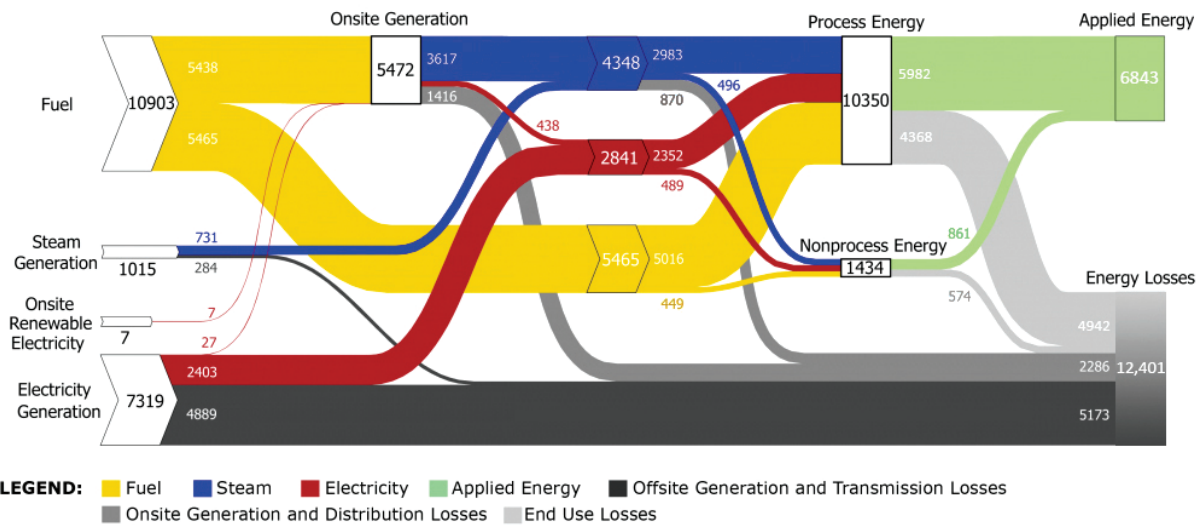
- **Goal 1:** Deploy current state-of-the-art technologies to achieve a 25% reduction in manufacturing energy intensity (energy consumed per unit of physical output) over ten years.<sup>3</sup>
- **Goal 2:** Pursue technology improvements to narrow the gap between current energy use and practical minimum energy requirements,<sup>4</sup> especially for major energy-intensive industries.
- **Goal 3:** Develop transformational next-generation materials, processes, and technologies that are not bound by current practical (energy and emissions) limitations.
- **Goal 4:** Invest in selected technologies for manufactured goods that will significantly lower energy intensity in the industrial, transportation, and buildings sectors that will achieve a minimum 50% life-cycle energy reduction within ten years, as well as technologies for clean energy generation and delivery that achieve a significant performance improvement in efficiency, cost, and/or durability.

Technologies of interest will have the potential to reduce the manufacturing sector's overall energy intensity and environmental impacts, including both direct and indirect (life cycle) impacts. Key manufacturing technologies and opportunities are explored in this chapter with goals such as these in mind.

## 6.2 Technology Opportunities in Manufacturing Systems – Unit Operations

Energy use at manufacturing facilities can be grouped into three key clusters of equipment: process systems, such as furnaces, dryers, pumps, and compressors; nonprocess systems, such as facility heating, lighting, and onsite transportation; and onsite generation systems, such as conventional boilers and combined heat and power (CHP) equipment used to produce electricity and steam. The Sankey energy flow diagram in Figure 6.4 illustrates the energy flow of the entire manufacturing sector, with fuel energy shown as a yellow flow line, steam as blue, and electricity as red. Approximately half of the fuel from offsite sources is transformed onsite at manufacturing facilities sector-wide to generate additional steam and electricity. The majority of energy from offsite and onsite

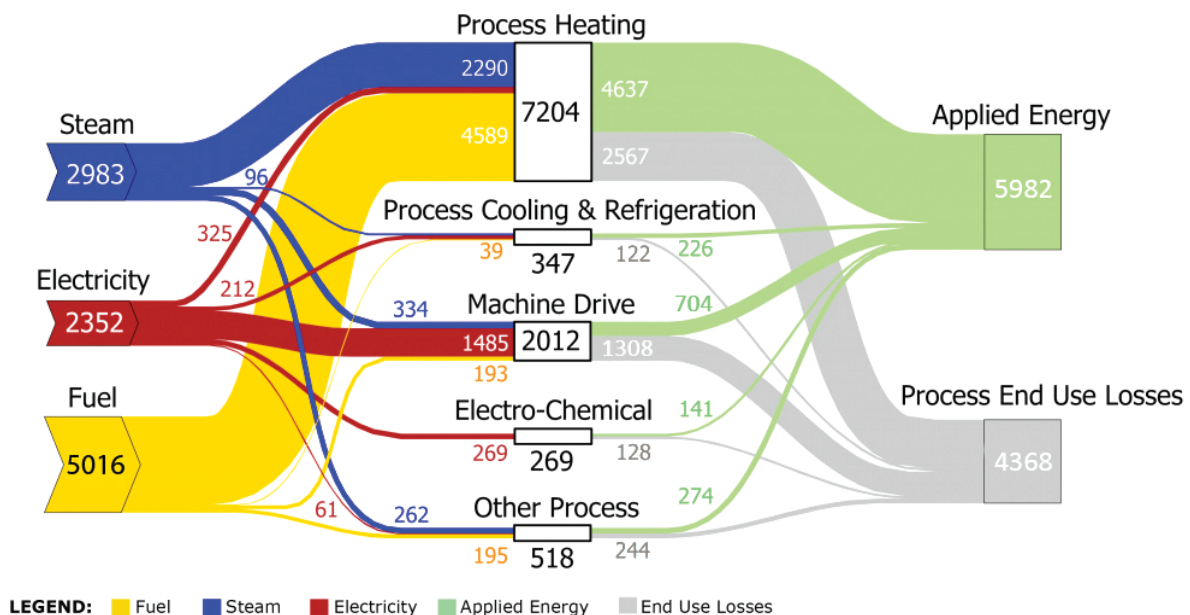
**Figure 6.4** Sankey Diagram of Primary Energy Flow (feedstock energy excluded) in the U.S. Manufacturing Sector (2010). Energy units are TBtu.<sup>5</sup>



generation sources is consumed by process end uses, while nonprocess facility end use accounts for a small fraction of consumption. The Sankey diagram also accounts for overall estimated energy losses, shown in gray, including generation and transmission losses (offsite and onsite generation) and end use losses.

Manufacturing process end uses are detailed in Figure 6.5, which shows that process heating and motor-driven systems dominate process energy consumption, accounting for 89% of process energy consumption.<sup>6</sup> For process heating systems, fuel and steam are the dominant forms of energy utilized, while electricity is the

**Figure 6.5** Sankey Diagram of U.S. Manufacturing Sector Process Energy Flow in 2010 (a subset of the overall manufacturing sector energy flows shown in Figure 6.4). Energy units are TBtu.<sup>9</sup>



prevailing form of energy for motor-driven systems. Considering a total energy consumption of 9,216 trillion British thermal units (TBtu) for process heating and motor driven systems in the manufacturing sector, a 10% overall energy efficiency improvement in these systems could provide nearly 1,000 TBtu of energy savings across all manufacturing industries. Further, transformational industry-specific unit operation technologies such as process intensification (chemicals), roll-to-roll processing (electronics), and additive manufacturing (fabricated metals) can provide direct benefits such as increased manufacturing efficiency and better product quality, as well as downstream life-cycle energy benefits.

### 6.2.1 Improving the Efficiency of Manufacturing Processes

Process heating and motor-driven systems collectively consume more than nine quads of end use energy in the U.S. manufacturing sector. Continued technology maturation and improvements will drive technology uptake to reduce energy intensity and can narrow the gap between current energy use and practical minimum energy requirements, especially for major energy-intensive commodities. Transformational next-generation processes and technologies that are not bound by practical (energy and emissions) limitations of current processes, such as low-thermal-budget processes and next-generation motor-driven systems, can drive manufacturing energy reductions and expand capabilities of manufacturers.

#### Process Heating Systems (including steam for unit operations)

Process heating accounts for approximately 61% of manufacturing end use energy use annually.<sup>7</sup> Energy for process heating is obtained from a combination of electricity, steam, and fuels such as natural gas, coal, biomass, and fuel oils. In 2010, process heating consumed approximately 330 TBtu of electricity, 2,290 TBtu of steam, and 4,590 TBtu of fuel.<sup>8</sup> Common process heating systems include equipment such as furnaces, heat exchangers, evaporators, kilns, and dryers. Characteristics of major manufacturing operations that involve process heating are shown in Table 6.1.

**Table 6.1** Characteristics of Common Industrial Processes that Require Process Heating<sup>10</sup>

Process heating operation	Description/example applications	Typical temperature range (F)	Estimated (2010) U.S. energy use (TBtu)
Fluid heating, boiling, and distillation	Distillation, reforming, cracking, hydrotreating; chemicals production, food preparation	150–1000°	3,015
Drying	Water and organic compound removal	200–700°	1,178
Metal smelting and melting	Ore smelting, steelmaking, and other metals production	800–3000°	968
Calcining	Lime calcining	1500–2000°	395
Metal heat treating and reheating	Hardening, annealing, tempering	200–2500°	203
Non-metal melting	Glass, ceramics, and inorganics manufacturing	1500–3000°	199
Curing and forming	Polymer production, molding, extrusion	300–2500°	109
Coking	Cokemaking for iron and steel production	700–2000°	88
Other	Preheating; catalysis, thermal oxidation, incineration, softening, and warming	200–3000°	1,049
<b>Total</b>			<b>7,204</b>



Waste heat losses are a major consideration in process heating, especially for higher-temperatures process heating systems such as those used in steelmaking and glass melting. Losses can occur at walls, doors and openings, and through the venting of hot flue and exhaust gases. Overall, energy losses from process heating systems total more than 2,500 TBtu annually.<sup>11</sup> The recovery and use of waste heat offers an opportunity to re-utilize wasted heat for other purposes (see *Waste Heat Recovery Systems* in Section 6.3.1). Alternatively, low-thermal-budget and selective heating techniques such as microwave, ultraviolet, and other electromagnetic processing methods, which deliver energy directly where it is needed rather than heating the environment, increase the proportion of useful heat energy delivered to the product, reducing the occurrence of waste heat.<sup>12</sup> In addition, these techniques are flexible, as process parameters such as the electromagnetic frequency, energy input, and spatial extent can often be monitored and actively controlled. Because the interaction of electromagnetic energy with matter varies from material to material, electromagnetic processing techniques can enable entirely new or enhanced manufactured products.

Novel processing techniques that involve lower temperature processing or fewer heating steps can also reduce energy consumption. Hybrid process heating systems that combine multiple forms of heat transfer (radiative, conductive, and/or convective methods) or multiple operations into a single piece of equipment (such as hybrid distillation systems) can reduce heating time, increase energy efficiency, and improve product quality. Key RDD&D opportunities for energy and emissions savings in industrial process heating operations are summarized in Table 6.2. While the total energy savings opportunity (2,210 TBtu) is very large, only a portion of this opportunity is technically and economically feasible to capture, as discussed in the *Waste Heat Recovery Systems* Technology Assessment.

**Table 6.2** RDD&D Opportunities for Process Heating and Projected Energy Savings<sup>13</sup>

R&D opportunity	Applications	Estimated annual energy savings opportunity (TBtu/yr)	Estimated annual carbon dioxide (CO <sub>2</sub> ) emissions savings opportunity (million metric tonnes [MMT]/yr)
Advanced non-thermal water removal technologies	Drying and concentration	500	35
“Super boilers” (to produce steam with high efficiency, high reliability, and low footprint)	Steam production	350	20
Waste heat recovery systems	Crosscutting	260	25
Hybrid distillation	Distillation	240	20
New catalysts and reaction processes (to improve yields of conversion processes)	Catalysis and conversion	200	15
Lower-energy, high-temperature material processing (e.g., microwave heating)	Crosscutting	150	10
Advanced high-temperature materials for high-temperature processing	Crosscutting	150	10
Net-shape and near-net-shape design and manufacturing	Casting, rolling, forging, additive manufacturing, and powder metallurgy	140	10
Integrated manufacturing control systems	Crosscutting	130	10
<b>Total</b>		<b>2,210</b>	<b>155</b>

## Motor-Driven Systems

Industrial machine and motor-driven systems include pumps, fans, compressors, air conditioners, refrigerators, forming and machining tools, robots, and materials processing and handling equipment. These systems account for 68% of manufacturing electricity consumption.<sup>14</sup> The majority of this energy is consumed in just three manufacturing sectors: chemicals, forest products, and food and beverage manufacturing. While electric motors have high efficiencies, end-use motor-driven systems have much lower system efficiencies, particularly for pumps, fans, compressed air and materials processing equipment. As a result, overall machine-driven system losses total 1,470 TBtu annually.<sup>15</sup> The total energy use for major categories of machine-driven systems in U.S. manufacturing is shown in Table 6.3.

**Table 6.3** Energy Use of Major Motor-Driven Systems in U.S. Manufacturing<sup>16</sup>

Primary manufacturing motor-driven systems	Estimated U.S. manufacturing energy use (2010)	
	(TBtu)	(GWh)
Pumps	614	180,100
Fans	291	85,240
Compressed air	333	91,560
Materials handling (e.g., conveyers, belts, materials movers)	175	51,300
Materials processing (e.g., grinding, agitating/mixing, debarking, drilling, pressing)	497	145,530
Process cooling and refrigeration	212	62,120
Facility heating, ventilating, and air conditioning (HVAC)	241	70,610

Key energy savings opportunities can be identified by focusing on opportunities to improve the motor system, rather than focusing solely on the motor. A 2004 study estimated the electricity savings opportunities from the use of available technologies on motor-driven systems.<sup>17</sup> Only 13% of these opportunities were from the motors, while variable speed drive adoption accounted for an additional 25%, and improvements to applications would account for the remaining 62%. In some cases, the efficiency of motor-driven systems can be enhanced by upgrading a motor to take advantage of newer, high-

efficiency technologies, but system design and appropriate sizing of motor and drive system to its application is critical to minimize energy losses.<sup>18</sup> Many industrial motors are sized to handle peak demand, and are often part of a system that is poorly engineered and inefficient.<sup>19</sup> Therefore, motor systems often use much more power than is needed, especially when the facility is running below peak throughput. Variable frequency drive (VFD) motors dynamically adjust motor speed to match power demands, and can thereby reduce energy consumption in industrial facilities. Opportunities also exist to better harmonize alternating current (AC) and direct current (DC) power to reduce conversion losses and improve power quality for industrial applications.<sup>20</sup>

Next-generation motor-driven systems will benefit from the development of improved wide bandgap (WBG) semiconductors (see *Wide Bandgap Semiconductors for Power Electronics* in Section 6.4.2), which are expected to enable more cost-effective and higher efficiency VFD systems. For example, WBG semiconductors are expected to accelerate the motorization of large compressors prevalent in the chemical, oil and gas industries, which could improve efficiencies and reduce fugitive methane emissions. In addition, the higher voltage capabilities, switching frequencies, and junction temperatures of WBG devices will enable the integration of medium voltage (MV) class motors with WBG-based VFDs. The resulting high-speed, high-frequency motor system may allow for elimination of a speed-increasing gearbox,<sup>21</sup> resulting in improvements in power density and footprint of the overall system and providing benefits in space-constrained applications.

Lastly, information technology is enabling more intelligent power use for a step-change impact in electric machines and motors. Beyond energy consumption reductions, benefits include more integrated and intelligent motor systems that can increase facility productivity.

## 6.2.2 New Manufacturing Approaches

Entirely new manufacturing approaches such as additive manufacturing and roll-to-roll processing, and highly optimized manufacturing operations based on process intensification paradigms, can form the basis for manufacturers to narrow the gap between current energy use and practical minimum energy requirements and can lead to transformational next-generation processes and technologies that are not bound by practical limitations of current processes.

### Process Intensification

Process intensification (PI) targets dramatic improvements in manufacturing and processing by rethinking existing operation schemes into ones that are both more precise and efficient. PI frequently involves combining separate unit operations such as reaction and separation into a single piece of equipment, resulting in a more efficient, cleaner, and economical manufacturing process. At the molecular level, PI technologies can significantly enhance mixing, which improves mass and heat transfer, reaction kinetics, yields, and specificity. These improvements translate into reductions in energy use, waste generation, environmental impact, and amount of equipment, and thereby minimize cost and risk in chemical manufacturing facilities.

Applications for PI technologies crosscut energy-intensive industries with opportunity space in chemicals, petroleum refining, plastics, forest products, and food industries, among others. PI innovation could deliver solutions to energy security, environmental, and economic challenges in areas including stranded gas recovery, carbon capture, and water treatment. PI is a key development platform for eco-efficient chemicals production. The chemicals sector has an annual onsite energy consumption of approximately 3,221 TBtu (not including chemical feedstocks) and combustion emissions of about 145 million metric tonnes CO<sub>2</sub>-equivalent (CO<sub>2</sub>-eq).<sup>22</sup> A European roadmapping analysis<sup>23</sup> concluded that R&D investment in PI technologies could lead to a 20% improvement in overall energy efficiency of petrochemical and bulk chemical production in thirty to forty years and to a 50% reduction in costs for specialty chemicals and pharmaceuticals production in ten to fifteen years.

The *2015 Bandwidth Study on Energy Use and Potential Energy Savings in U.S. Chemical Manufacturing*<sup>24</sup> analyzed energy consumption and savings opportunities for some of the top energy-consuming chemicals in the United States. Based on the bandwidth analysis, eleven chemicals (listed in descending order of energy consumption in Table 6.4) were found to have significant opportunities for energy savings via implementation of PI technologies. In 2010, the production processes for these eleven chemicals consumed an estimated 1,370 TBtu of energy,<sup>25</sup> accounting for 43% of the total onsite energy consumed in the chemicals industry. Table 6.4 shows estimates of the energy savings opportunity from successful development and implementation of PI technologies for each of the chemicals, totaling 695 TBtu/yr.<sup>26</sup>

Although PI is a promising approach for increasing the energy efficiency of chemical processes and reducing costs, PI for many potential applications is still in the early stages of technology readiness. Considerable potential exists for near- and long-term energy use and carbon emission reductions through the development of PI technologies and novel processes. RDD&D investment in PI technologies could have wide ranging applicability across the chemical industry as well as other industries. PI approaches that optimize energy recovery through process integration may be particularly impactful. Metrics of successful PI RDD&D

**Table 6.4** 2010 Production, Calculated Onsite Energy Consumption, and Energy Savings Potential for Eleven Chemicals<sup>27</sup>

Chemical	Annual production (million lbs/yr)	Calculated onsite energy (TBtu/yr)	Energy reduction opportunity (TBtu/yr)
Ethanol	66,100	307	264
Ethylene	52,900	374	107
Ammonia	22,700	133	78
Benzene	13,300	104	67
Chlorine/sodium hydroxide	21,500/16,600	203	87
Nitrogen/oxygen	69,600/58,300	99	18
Ethylene dichloride	19,400	66	37
Propylene	31,100	42	11
Acetone	3,180	25	18
Ethylene oxide	5,880	11	4
Methanol	2,020	10	4
<b>Total</b>	<b>382,000</b>	<b>1,370</b>	<b>695</b>

include cost reduction, energy efficiency, carbon efficiency, and waste reduction compared to state-of-the-art technologies. Key areas for RDD&D include the following:

- **PI equipment**, involving improved physical hardware and optimized operating parameters for improved chemicals processing environments and profiles, such as novel mixing, heat-transfer and mass-transfer technologies.
- **PI methods**, including improved or novel chemical processes (e.g., new or hybrid separations, integration of reaction and separation steps, improved heat exchange) or phase transition (multifunctional reactors), the use of a variety of energy sources (light, ultrasound, magnetic fields), and new process-control methods (intentional non-equilibrium-state operation).
- **PI supporting practices**, such as improved manufacturing processes for new equipment and improved systems integration, common standards and interoperability, modular systems design and integration, supply chain development and flexibility, workforce training, and financing.

### Roll-to-Roll Processing

Roll-to-roll (R2R) manufacturing is an important class of substrate-based manufacturing processes in which additive and subtractive processes are used to build structures in a continuous manner. Typical R2R operations include casting, extrusion, coating, and printing of two-dimensional products. R2R enables low-cost production of complex-functional, large surface area devices needed for many clean energy applications and many R2R products cannot be produced using other known techniques. Examples of applications for R2R manufacturing include the following:

- **Flexible electronics** for solar panels, printed electronics, displays, thin film batteries, multilayer capacitors, smart labels (e.g., radio frequency identification tags and antennas), and thin-film detectors and sensors.

- **Separation membranes**, such as indoor air quality and dehumidification membranes, gas separation membranes for natural gas processing and CO<sub>2</sub> capture, forward-osmosis capacitive polarization membranes for water processing, and polymer electrolyte membranes for fuel cells.
- **Photovoltaics** for flexible organic solar cells, power provision (especially lighting) for buildings, and battery charging.

Technical advances in R2R manufacturing for these applications can be realized by RDD&D in the following areas:

- **Deposition and patterning technologies:** Process tools for core capabilities such as deposition processes, including evaporation, sputtering, electroplating, chemical vapor deposition, atomic layer deposition, laser ablation, and imprint/soft lithography.
- **Precursors and inks:** Development of precursor materials and inks for printed materials with stable, uniform material properties.
- **Multilayer processing:** Fabrication techniques for layered and functionally graded materials.
- **Metrology for inspection and control:** Metrology and instrumentation for inspection and quality control of R2R manufactured products. Real-time data monitoring systems and process models are needed for adaptive and predictive process control at speeds relevant to production.

## Additive Manufacturing

Emerging additive manufacturing (AM) technologies are projected to have a transformational impact on manufacturing by dramatically reducing materials and energy use, eliminating production steps, enabling simpler component designs, eliminating costly part tooling, and supporting increased distributed manufacturing at the point-of-use. Unlike conventional fabrication methods that use machining processes to cut away material from molded or cast objects, AM techniques build up objects layer-by-layer to create end products directly from a computer model, reducing material use by up to 90%.<sup>28</sup> Additive manufacturing enables the production of many complex structures that cannot be manufactured by other means, such as embedded features and other complex geometries; however, it is important to note that AM processes are associated with size and material property limitations that restrict their use to certain applications. AM technologies that have been introduced into the commercial market, along with their material compatibilities, are shown in Table 6.5.

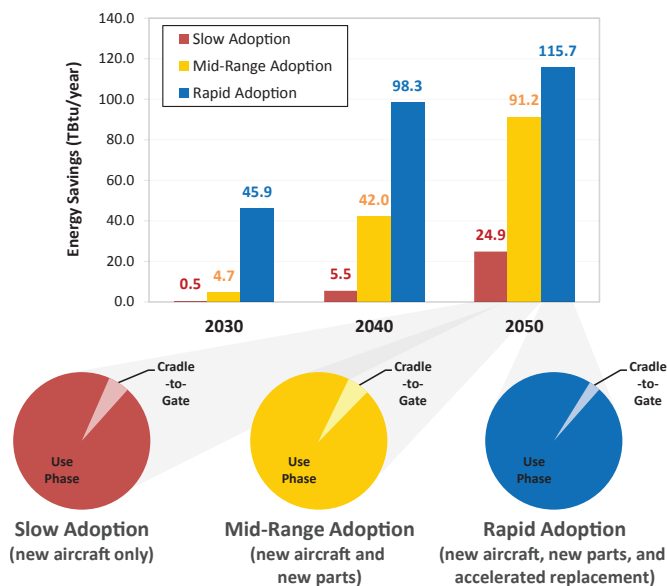
Additive manufacturing can provide life-cycle benefits in multiple sectors compared to conventional manufacturing by reducing the amount of required raw material, reducing the ultimate weight of a component, and minimizing part count. As an example, Figure 6.6 shows the projected impacts for the penetration of AM components into the U.S. aircraft fleet over the next thirty-five years. With rapid adoption, annual energy savings could approach 100 TBtu by 2040 for this application area alone. Energy benefits attained through use of additive manufacturing depend on the specific product being manufactured; life-cycle analysis is useful to assess the actual energy savings possible.

To realize the full potential of additive manufacturing, technology solutions are needed to improve dimensional accuracy, improve the mechanical and physical properties of the finished part, increase throughput, and reduce the minimum feature size that can be fabricated, requiring RDD&D to address the following key technical challenges:<sup>29</sup>

- **Process control:** Feedback control systems and metrics are needed to improve the precision and reliability of the manufacturing process and to increase throughput while maintaining consistent quality. Feedback control is especially challenging for AM processes with rapid deposition rates. The ability to tailor the material microstructure *in situ* could improve performance properties.
- **Tolerances:** Some potential applications would require micron-scale accuracy in printing.

**Table 6.5** Additive Manufacturing Process Technologies and Materials Compatibilities (as classified by ASTM F42)<sup>30</sup>

Process type	Brief description	Related technologies	Materials
Powder bed fusion	Thermal energy selectively fuses regions of a powder bed	Electron beam melting (EBM), selective laser sintering (SLS), selective heat sintering (SHS), and direct metal laser sintering (DMLS)	Metals, polymers
Directed energy deposition	Focused thermal energy is used to fuse materials by melting as the material is being deposited	Laser metal deposition (LMD)	Metals
Material extrusion	Material is selectively dispensed through a nozzle or orifice	Fused deposition modeling (FDM)	Polymers
Vat photopolymerization	Liquid photopolymer in a vat is selectively cured by light-activated polymerization	Stereolithography (SLA), digital light processing (DLP)	Photopolymers
Binder jetting	A liquid bonding agent is selectively deposited to join powder materials	Powder bed and inkjet head (PBIH), plaster-based 3D printing (PP)	Polymers, foundry sand, metals
Material jetting	Droplets of build material are selectively deposited	Multi-jet modeling (MJM)	Polymers, waxes
Sheet lamination	Sheets of material are bonded to form an object	Laminated object manufacturing (LOM), ultrasonic consolidation (UC)	Paper, metals

**Figure 6.6** Projected Annual Energy Savings (Tbtu/year) for Fleet-wide Adoption of Additive Manufactured Components in Aircraft, Assuming Slow, Mid-range and Rapid Adoption Scenarios. In this example, energy savings were driven by the use phase.<sup>31</sup>

- Finish:** The surface finishes of products manufactured using additive technology require further refinement. With improved geometric accuracy, finishes may impart improved tribological and aesthetic properties.
- Electrical power:** The impact of power quality on additive manufacturing equipment is not well understood. Power variations and interrupts can impact the quality of the item produced using additive manufacturing by introducing defects that may not be detected. To evaluate the power quality characteristics of AM equipment and develop a better understanding of the design and makeup of this new type of manufacturing system requires research.

## Automotive Applications of Additive Manufacturing

**Figure 6.7** Delphi Diesel Engine Pump Housing  
Fabricated via Selective Laser Melting  
Credit: Delphi Automotive



Delphi Automotive, a Tier 1 automotive parts manufacturer, currently uses an additive manufacturing technique (selective laser melting) to produce aluminum diesel pumps, as shown in Figure 6.7.<sup>32</sup> The life-cycle energy consumption for the additive process and the conventional gravity die casting process are compared in Table 6.6. Energy savings result from reduced material requirements for the additive process. Selective laser melting reduces the amount of scrap produced during manufacturing of the part; the reduced weight of the finished component also provides use phase energy savings.

**Table 6.6** Life-Cycle Energy Comparison for an Aluminum Diesel Engine Pump Housing Manufactured via Gravity Die Casting and Selective Laser Melting<sup>33</sup>

Life cycle stage	Gravity die casting energy use (kBtu)	Selective laser melting energy use (kBtu)
Raw materials	305	64
Manufacture	5	28
Transportation	45	7
Use phase	324	73
End of life*	1	0
<b>Total</b>	<b>681</b>	<b>173 (75% energy savings)</b>

\* End-of-life energy use is negligibly small for the selective laser melting process.  
Key: **kBtu** = thousand Btu.

- **Material compatibility:** Materials that can be used with additive manufacturing technologies are currently limited to a relatively small set of compatible materials. There is a need for new polymer and metal materials formulated for additive manufacturing to provide materials properties such as flexibility, conductivity, transparency, safety, and low embodied energy.
- **Validation and demonstration:** Manufacturers, standards organizations, and others maintain high standards for critical structural materials, such as those used in aerospace applications. Providing a high level of confidence in the structural integrity of components built with additive technology may require testing, demonstration, and data collection.
- **Modeling:** Data-based models of additive manufacturing processes are needed to promote real-time process control and to increase understanding of multi-material additive processes, where interface issues such as bonding and thermal expansion can present significant issues.

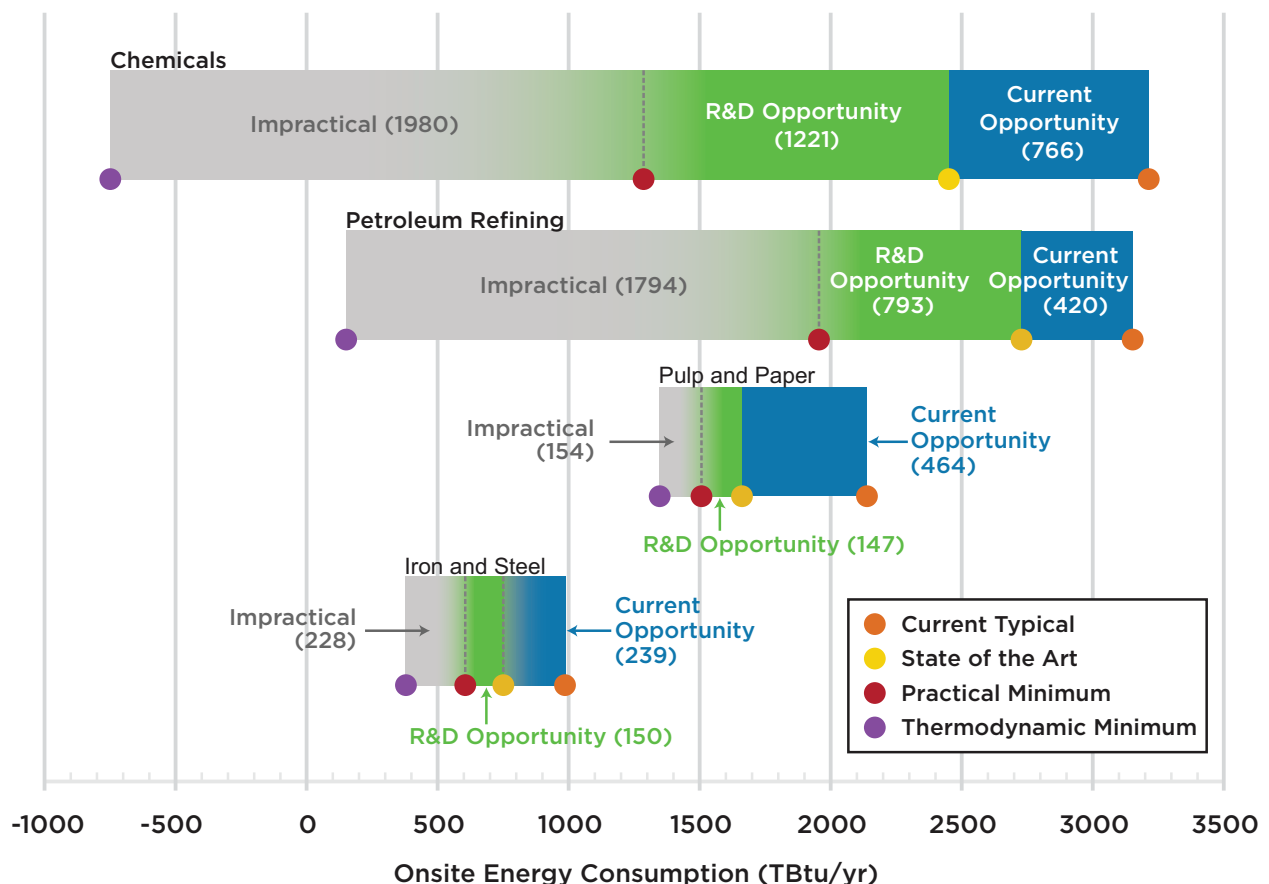
In addition to technological challenges, there are business challenges to be addressed; for example, industry designers are familiar with conventional manufacturing methods, and parts are often designed based on conventional manufacturing processes. Widespread adoption of additive manufacturing will require education, training, and approaches to mitigate business risks associated with the transition to a rapidly advancing technology.

### 6.3 Technology Opportunities for Production/Facility Systems – Energy and Resource Utilization

Numerous studies have examined the potential for energy efficiency improvements in production/facility systems, which integrate manufacturing equipment and practices into goods-producing facilities. For example, bandwidth studies assess potential energy savings opportunities by comparing the amount of energy typically consumed at a manufacturing facility to produce a particular product to the state-of-the-art and practical minimum amounts of energy needed to achieve the same results.<sup>34</sup>

Figure 6.8 shows the bandwidth summaries for four energy-intensive manufacturing sectors. The lower bound of the energy bandwidth is defined by the theoretical minimum energy requirement, assuming ideal conditions and zero energy losses (the thermodynamic minimum level of energy consumption). The upper bound represents the current energy consumption (based on average energy intensities for key processes at existing

**Figure 6.8** Bandwidth Diagrams Illustrating Energy Savings Opportunities in Four Energy-Intensive U.S. Manufacturing Industries. Current opportunities represent energy savings that could be achieved by deploying the most energy-efficient commercial technologies available worldwide. R&D opportunities represent potential savings that could be attained through successful deployment of applied R&D technologies under development worldwide.<sup>35</sup>





manufacturing facilities). The current energy savings opportunity, shown in blue for each sector, represents the savings potentially attainable through state-of-the-art technology adoption. The R&D savings opportunity, shown in green, represents additional energy savings potentially attainable through adoption of applied research and development. The point of transition labeled Practical Minimum is inexact and for this reason is shown as a dashed line between the future savings opportunity and the impractical region (shown in gray). The current and R&D opportunity bandwidths are based on technical energy savings potential and do not take costs into account. Bandwidth diagrams can help one to quickly and holistically assess the magnitude of potential opportunities for energy savings for a sector or manufacturing process.

### 6.3.1 Improving Fuel Flexibility and Reducing Waste Energy

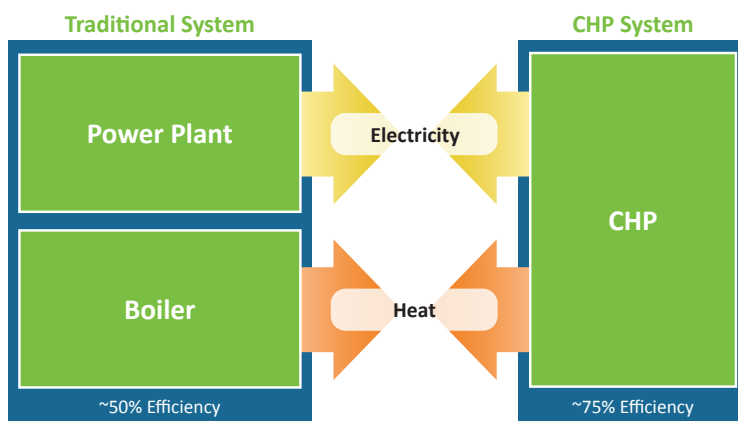
Industrial-scale energy systems integration provides a systems approach to optimize energy use at manufacturing facilities through technologies that can increase energy flexibility and reduce/recover/re-use waste energy, leading to reduced energy intensity, and narrowing the gap between current energy use and practical minimum energy requirements.

#### Combined Heat and Power Systems

CHP is the concurrent production of electricity or mechanical power and useful thermal energy from a single energy input, as shown in Figure 6.9. CHP technologies provide manufacturing facilities, commercial and institutional buildings, and communities with ways to reduce energy costs and emissions while also providing more resilient and reliable electric power and thermal energy. CHP systems combine the production of heat (for both heating and cooling) and electric power into one process, using much less fuel than when heat and power are produced separately. CHP systems can achieve overall energy efficiencies of 75% or more,<sup>36</sup> compared to separate production of heat and power, which collectively averages about 50% efficiency.<sup>37</sup> A recent executive order has set a national target of 40 gigawatts (GW) of additional CHP capacity by 2020,<sup>38</sup> an increase of nearly 50% above the current installed capacity of 83 GW.<sup>39</sup>

DOE analyses have identified R&D opportunities to increase the power-to-heat ratio of 1–10 MW CHP systems while maintaining the high overall system efficiencies of traditional thermally-sized CHP systems. This would entail the development of ultra-high-efficiency generation technologies. Existing CHP systems on average generate much more steam than electricity, with power-to-heat ratios<sup>40</sup> of individual systems as low as 0.1 but

**Figure 6.9** CHP systems produce thermal energy and electricity concurrently from the same energy input, and can therefore achieve higher system efficiencies than separate heat and power systems.



more commonly between 0.5 and 1, depending on the technology utilized.<sup>41</sup> If highly efficient CHP systems with a power-to-heat ratio of 1.5 were deployed, energy savings of up to 144 TBtu could be realized in the manufacturing sector, with economy-wide energy savings of 1,310 TBtu, as shown in Table 6.7.

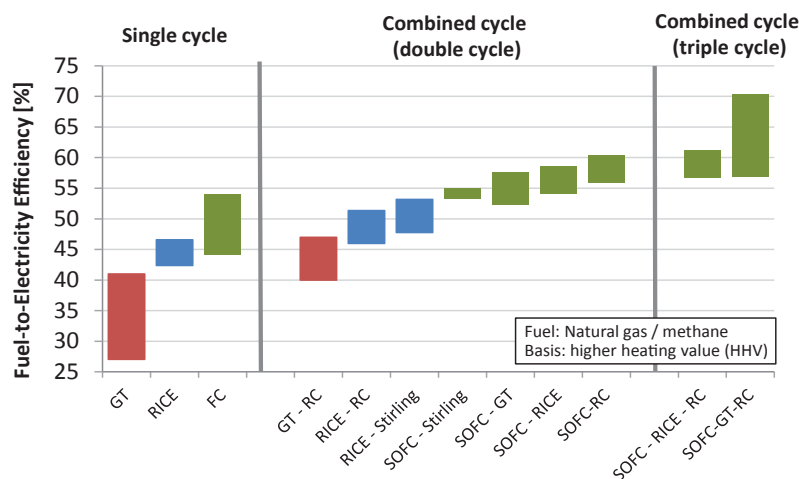
**Table 6.7** Technical Potential and Energy and Cost Savings for High Power-to-Heat CHP Operation

	Energy benefits for high power-to-heat CHP operation		
	Manufacturing sector	Commercial/ institutional sector	Total
Incremental capacity potential (GW)*	4.7	45.1	<b>52.9</b>
Incremental annual primary energy savings (TBtu)**	144	1,160	<b>1,310</b>
User incremental energy cost savings (\$ Millions)	\$1,316	\$8,660	<b>\$9,976</b>

\* Incremental CHP capacity based on a power-to-heat ratio of 1.5.

\*\* Incremental primary energy savings based on a 33% average grid efficiency.

**Figure 6.10** Theoretical Efficiencies (electric generation only) for Various CHP Configurations, Ranging from Single-Cycle Systems to Double- and Triple-Cycle Systems that Make Use of Multiple Generation Technologies. Efficiencies of up to 70% are theoretically possible.<sup>42</sup>



Key: GT = gas turbine; RICE = reciprocating internal combustion engine; FC = fuel cell (molten carbonate or solid oxide); SOFC = solid oxide fuel cell; RC = Rankine cycle; Stirling = Stirling cycle.

Based on thermodynamic analysis of several generation equipment configurations, electrical efficiencies up to 70% are theoretically possible with reconfigurations of existing generating technologies, as shown in Figure 6.10. The amount of thermal energy available for use will vary based on the electrical efficiency and technologies employed.

R&D opportunities and research targets for the development of ultra-high efficiency CHP generation technologies are shown in Table 6.8 for consideration by decision makers.

### Waste Heat Recovery Systems

Industrial process heating, which consumes more than 7,000 TBtu of energy annually,<sup>43</sup> is used for fundamental materials transformations including heating, drying, curing, and phase change. Process heating systems are associated with significant thermal losses; nearly 36% of the total energy input to process heating is lost as waste heat.<sup>44</sup> The largest sources of waste heat for most industries are exhaust gases from burners, heat treating furnaces, dryers, and other equipment. Waste heat can also be released to liquids such as cooling water, heated wash water, boiler and blow-down water. Solid waste heat sources include hot products that are discharged after processing or after reactions are complete, hot by-products from processes or combustion of solid materials,

**Table 6.8** Strategic R&D Opportunities and Performance Targets for Consideration by Decision Makers

Near-term areas (< five years)		Long-term areas (> five years)	
R&D opportunity	Goals	R&D opportunity	Goals
<p><b>CHP packaging for single buildings/facilities:</b> Packaged systems to avoid need for custom equipment design and onsite engineering expertise</p>	<ul style="list-style-type: none"> <li>■ Target equipment size range 1–5 MW</li> <li>■ Capital cost less than \$1,500/kW</li> <li>■ Levelized cost of electricity less than \$0.10/kWh</li> </ul>	<p><b>High power-to-heat ratio CHP:</b> Systems with efficient onsite electricity generation for facilities dominated by electrical loads</p>	<ul style="list-style-type: none"> <li>■ Target equipment size range 1–10 MW</li> <li>■ 65% electric generation efficiency, with high (&gt;75%) overall CHP efficiency</li> <li>■ Power-to-heat ratio up to P/H = 1.5</li> </ul>
<p><b>Grid integration:</b> Technical solutions to enable grid interconnection, demand response and ancillary services</p>	<p>Facility needs met while safely and seamlessly providing grid support</p>	<p><b>Waste heat recovery and waste heat to power:</b> Technologies for improved thermal recovery in CHP</p>	<p>Improved reliability, availability, maintainability, and durability for low-temperature recovery</p>
<p><b>Microgrid with CHP:</b> Small-scale autonomous energy grids with CHP generation, and possible facilitation of intermittent renewable sources, storage, energy efficiency measures, etc.</p>	<p>Improved synchronization, controls, and cybersecurity</p>	<p><b>Smart CHP:</b> Full integration of onsite generation and CHP into a smart grid</p>	<p>Specific technical goals in development</p>
<p><b>District energy with CHP:</b> Systems to enable use of rejected heat from CHP facilities to provide steam, hot, and chilled water to network buildings</p>	<p>Reduced system capital and installation costs</p>		

and hot equipment surfaces. The quality of these heat sources varies. Industrial waste heat generally occurs in four forms:

- Sensible heat of solids, liquids, and gases
- Latent heat contained in water vapor or other type of vapors and gases
- Radiation and convection from hot surfaces
- Direct contact conduction (in a few instances)

While every effort should be made to reduce waste heat losses (for example, by integrating advanced insulation techniques and selective heating technologies into process heating equipment, as discussed in *Process Heating Systems*—see Section 6.2.1), some heat losses are unavoidable. The recovery and reduction of waste heat generated in manufacturing systems offers an opportunity to reduce manufacturing energy use and associated emissions. Waste heat can be recycled either by redirecting the waste stream for use in other thermal processes (e.g., flue gases from a furnace could be used to pre-heat a lower-temperature drying oven) or by converting the waste heat to electricity in a process called waste heat-to-power (WHP). In some cases, the technologies needed to economically recover waste heat from hot gases, liquids, or solids are already available. However, industrial facilities often do not implement these technologies, based in part on technology issues (e.g., fouling,

corrosion, and high maintenance requirements). According to U.S. Energy Information Administration (EIA) *Manufacturing Energy Consumption Survey* data, approximately 6% of U.S. manufacturing facilities were using some type of waste heat recovery as of 2010.<sup>45</sup>

Improvements in current waste heat recovery technologies could enable increased deployment in industrial facilities. Industrial users demand equipment lifetimes of several years, low maintenance and cleaning requirements, and consistent and reliable performance over acceptable life. For low-temperature waste heat streams (i.e., less than 400°F), low heat transfer rates and large recovery equipment footprints are major barriers. For high-temperature waste heat streams (i.e., above 1200° F), materials are needed that can withstand high-temperature gases that may be contaminated with particulate matter or corrosive chemicals.<sup>46</sup> To address these challenges requires RDD&D in the following:

- Anti-fouling technologies that can remove contaminants from waste heat streams or mitigate build-up of debris on heat exchanger surfaces, promoting long-term operation of heat recovery equipment and avoiding service interruptions for cleaning
- Advanced materials that can withstand high-temperature waste heat sources
- Compact, low-cost heat exchangers to reduce the size or footprint of heat recovery equipment
- Secondary heat recovery technologies to supplement and enhance the performance of primary waste heat recovery equipment
- Heat recovery chillers that capture waste heat from chilled water systems
- Integrated heat recovery technologies that combine heating elements with heat recovery equipment, eliminating the need for hot-air piping and external heat recovery equipment
- Innovative condensing heat exchangers for gases containing high moisture levels and particulates, such as the waste streams discharged from paper and food production equipment
- Liquid-to-liquid heat exchangers for heat recovery from wastewater that contains contaminants
- Solid-state (e.g., thermoelectric) generators for electricity production from otherwise unusable waste heat streams (see *Direct Thermal Energy Conversion Materials, Devices, and Systems* in Section 6.4.2)
- Industrial heat pumps, including chemical heat pumps (e.g., adsorption/desorption and chemical looping reactions)

### 6.3.2 Harnessing Data for Energy Impacts

Data and automation can accelerate processing, increase real-time feedback, and optimize energy use at every manufacturing systems level. Advances made in production/facility systems can optimize manufacturing systems utilization and enable increased industrial energy systems integration, driving improvements through supply chains and narrowing the gap between current energy use and practical minimum energy requirements across industries.

#### Advanced Sensors, Controls, Platforms and Modeling for Manufacturing

Advanced sensors, controls, platforms and modeling for manufacturing (ASCPMM) represents an emerging opportunity for the U.S. manufacturing sector. ASCPMM technologies include infrastructure, software and networked solutions for sensing, instrumentation, control, modeling, and platforms for manufacturing applications. These technologies interact in a machine-to-plant-to-enterprise-to-supply-chain ecosystem of real-time data and models networked for enterprise and ecosystem optimization. When aligned with business models and communication networks, the use of ASCPMM technologies can improve manufacturing efficiency through the real-time management of energy, productivity and costs at the level of the machine, factory and enterprise, including improved integration with the electric grid. Data, information technology, and advanced models make it possible to dynamically and proactively manage power together with other integrated aspects

such as machine configurations to manage production volume and energy, minimize defects, and avoid abnormal situations that result in energy losses. In addition, data and advanced control systems make it possible to manage to tighter power quality constraints while also managing variations expected with two-way power flows and a wider range and diversity of power sources.

The White House Advanced Manufacturing Partnership (AMP) 2.0 Steering Committee provided a few examples of ASCPMM energy and cost impacts in their recent *Accelerating U.S. Advanced Manufacturing* (2014) report:<sup>47</sup>

- With advanced sensing and model-based optimization techniques, an aerospace metal parts manufacturer expects to save on the order of \$3 million per year on furnace operations alone in a plant that includes both continuous and discrete processes.
- A chemicals company projects 10%–20% energy savings for a hydrogen production plant with improved sensors and modeling, translating to a reduced natural gas cost of \$7.5 million per year.
- A three-mill cement grinding plant reduced specific energy consumption by as much as 5% with a customized model-predictive control approach.
- A robotic assembly plant for a large original equipment manufacturer anticipates reducing energy consumption by 10%–30% using optimization tools for robot motion planning.

Key technical needs to fully realize the energy benefits of ASCPMM include the following:

- Open standards and interoperability for manufacturing devices and systems
- Real-time measurement of machine energy consumption and waste streams
- Integration of manufacturing facilities with the electric grid to allow dynamic energy optimization and guide choices of fuel/power use and generation and purchase decisions
- Low-power, resilient wireless sensors and sensor networks for pervasive sensing
- Platform infrastructures for orchestration of data across heterogeneous and human systems while addressing issues of privacy and cybersecurity
- Theory and algorithms for model-based control of manufacturing processes
- Cybersecurity and privacy protection for sensitive data and systems

### Industrial Demand-Side Management

Managing the energy requirements (demand) of industrial facilities can be accomplished through energy-use reductions, as well as via temporal shifts in energy use. While end-use efficiency technologies can reduce average energy consumption, utility demand-side management (DSM) programs seek to change consumers' energy use patterns.<sup>51</sup> Industrial customer electricity bills are typically composed of time-of-use based electricity rates and demand charges, which incentivize load reductions during the utility system peak and the industrial facility peak. Industrial customers can further reduce electricity costs through interruptible and curtailable electricity rates, in exchange for allowing the utility to reduce a portion of the facility load when needed. Economically, this approach benefits both the grid and rate payers by enabling efficient dispatch of electric generators and by avoiding the building of costly excess capacity to meet peak demands. Industrial customers constitute the largest demand-side contribution to peak load reduction potential with an estimated 47% of the total across all retail programs,<sup>52</sup> as well as additional peak load reduction potential through wholesale programs in regions with organized wholesale electricity markets.

Typically, DSM programs have focused on large commercial and institutional customers that have noncritical loads or can compensate for power variations with backup power generation. Many manufacturing facilities already participate in manual DSM programs (e.g., peak shaving programs), but their peak-shaving

## Applications of Advanced Sensors, Controls, Platforms and Modeling for Strategic Energy Management

By helping to mitigate deficiencies in the ability to measure and manage energy, ASCPMM technologies show great promise in optimizing and accelerating the uptake of new and emerging manufacturing technologies. In addition, as ASCPMM equipment becomes more advanced and less costly, more types of equipment and plant operations will be monitored at a more granular level to enable greater energy savings, emission reductions, and productivity benefits. ASCPMM technologies are expected to enable these significant improvements in manufacturing facility energy performance and efficiency through the automated control and tailored analysis of data captured from factory networks.

The data-driven approach enabled by ASCPMM technologies is being facilitated by manufacturing facilities adopting a systematic approach to energy management that helps to institutionalize the important role played by ASCPMM technologies to improve energy performance and optimize operations. While manufacturers have traditionally viewed energy as a fixed monthly expense, a systematic approach to managing energy that continuously monitors energy performance is proving to yield sustained energy savings and reduced operational costs.<sup>48</sup> This strategic, data-driven approach to facility energy management reveals the need for improved data collection methods such as submetering of significant energy uses. Submetered manufacturing processes can provide real-time, equipment-specific energy consumption data and automated process alerts. In addition, equipment submetering also helps to identify equipment that is nearing failure, proactively reducing equipment downtime through preventive maintenance and extending the service life of facility equipment.

One example of a DOE program that emphasizes a systematic approach to energy management in U.S. manufacturing facilities is the U.S. DOE Superior Energy Performance<sup>®</sup> (SEP<sup>™</sup>) Program. Launched in 2014, SEP is an industrial energy management certification program that is accelerating the realization of ASCPMM benefits by emphasizing the value of improved data measurement and operational control for enhanced energy performance. SEP utilizes the ISO 50001 energy management standard as its foundation, augmented with quantitative energy performance improvement targets and requirements for third-party measurement and verification of energy savings. The SEP program requires that manufacturers meter, monitor, and record energy consumption data at their SEP-certified facilities.<sup>49</sup> As a result, SEP-certified facilities are installing energy management metering systems to measure, manage, and optimize energy performance as a key performance variable. Such metering and monitoring equipment demonstrates that energy efficiency activities yield a positive return on investment, helping to accelerate the adoption of cost-effective, energy-efficient technologies in manufacturing facilities.<sup>50</sup>

contribution is often limited to less-critical and/or time-flexible process loads such as HVAC. HVAC electricity usage constitutes just 8% of total manufacturing sector electricity consumption—relatively low compared to process electricity uses such as pumps, compressed air, and materials processing equipment.<sup>53</sup> However, there are a number of examples where manufacturing facilities have implemented DSM for more critical process loads, for instance electrolysis loads found in aluminum production.<sup>54</sup> The state of Texas has a long history of industrial customer participation in DSM programs, which transitioned to the wholesale market with the formation of the Electric Reliability Council of Texas (ERCOT). Most of the load resource capacity in ERCOT

comes from large industrial electro-chemical process loads. The ten largest resources account for more than one GW in load reduction capacity.<sup>55</sup> In 2012, electric utility providers reported peak demand savings of 5.7 GW from industrial customer participation in demand response programs—an increase of 19% since 2010, when peak demand savings were reported as 4.8 GW.<sup>56</sup>

The U.S. industrial base is large, and facilities are typically managed by staff comfortable with sophisticated processes and controls; as a result, the technical potential for industrial participation in flexible load programs is significant.<sup>57</sup> Industrial loads depend on a wide range of variables including end-uses and equipment, industry sub-sector, facility type, facility capacity size, age, and product specialization; as a result, technical potential and cost evaluations are often specific to individual facilities. This heterogeneity creates significant challenges for utilities and policy makers seeking to develop programs that provide attractive value incentives to industrial ratepayers.<sup>58</sup>

Historically, DSM has focused on reducing utility peak loads; however, there is also a growing interest in a wider range of grid ancillary and flexible load services that shape loads to balance renewable generation, provide demand-side capacity reserves, and enhance frequency control for electricity quality to ensure a stable and reliable grid. These services are collectively termed “grid integration.”<sup>59</sup> Efforts are currently underway to understand how the electric grid might operate in the future, especially if the generation capacity were significantly altered to accommodate larger contributions from naturally variable renewables such as wind and solar energy,<sup>60</sup> significant penetration of electric vehicles,<sup>61</sup> greater distributed generation capacity,<sup>62</sup> and flexible load services to reduce electricity costs and enhance grid reliability.<sup>63</sup> ASCPMM technologies<sup>64</sup> combined with a Smart Grid<sup>65</sup> offer new opportunities for the next generation of manufacturing to integrate and optimize their power flows.<sup>66</sup> These opportunities will require substantially different optimization protocols to manage and proactively shape peak loads, dynamically manage two-way power flows, and dynamically manage, control, and adjust to load and frequency variations as a result of a more diverse portfolio of source services. Data, predictive models, control, and enterprise optimization are crucial.

However, attracting large-scale manufacturing sector participation in these programs will require key technology developments and a demonstration of value:

- **Demand-response-ready equipment:** Manufacturing equipment that is compatible with demand response without compromising production quality
- **Compatible energy management systems:** Energy management systems with submetering to provide actionable information for manufacturing facility managers
- **Protocols for demand response:** Automated demand response (AutoDR) standards for communications between the electric grid and manufacturing facility processes
- **Value proposition:** Economically attractive demand response (DR) rate tariffs that provide incentives for load flexibility over a wide range of time periods (i.e., sub-second to days)

Because the value proposition for industrial customers is not yet well understood, the cost-effective potential for participation in flexible load programs is also poorly understood. Some efforts have been introduced to evaluate industrial load flexibility,<sup>67</sup> but many facility managers lack the detailed data of their own energy flows required to have confidence in demand management decisions and long-term capital investments. These information gaps can be addressed through improved industrial facility auditing and evaluation methods and tools, and ubiquitous ASCPMM technologies to measure and control energy flows. Successful technology options could result in a tighter link between the electric grid and industry, wherein industry increasingly integrates electricity generation and electric grid ancillary services into their operations. This approach can lead to a more integrated approach to energy production and manufacturing, with highly optimized coordination of industrial production, clean power generation, and energy management.

## 6.4 Beyond the Plant Boundaries: Technology Opportunities for Supply Chain Systems and Manufactured Goods

Manufactured products reach all end-use sectors, and as a result it is important to consider the energy impacts of manufactured goods in a life cycle accounting of overall energy and emissions effects. Lightweight materials such as aluminum, magnesium, advanced high strength steel, and composites are currently enabling reductions in the weight of light-duty vehicles, providing use phase energy savings—and additional materials and manufacturing technology advances could extend the applicability and benefits of these materials.<sup>68</sup> In some cases, next-generation technologies may have an outsized effect on energy consumption in the manufacturing sector, delaying or reducing the energy savings in the overall life cycle of the product. For example, carbon fiber composites are being introduced for vehicle lightweighting, despite the fact that carbon fibers now require significantly more energy to manufacture than a performance-equivalent quantity of steel. The application of carbon fiber technology for lightweighting vehicles can provide fuel economy energy benefits during the vehicle use phase that exceed the additional energy it takes to manufacture the material;<sup>69</sup> although fleet-wide energy benefits are not realized immediately. Similarly, the production of solid state lighting products (i.e., light-emitting diode [LED] lamps) is more energy intensive than the production of traditional incandescent light bulbs. However, LED lamps have a significantly longer lifespan and use less energy than incandescent bulbs, leading to lower life-cycle energy consumption.<sup>70</sup>

Manufacturing technology opportunities that could provide significant energy impacts in other sectors include the next generation of energy-efficient products and materials, such as wide bandgap power electronics, lightweight structural materials, and advanced materials for harsh service conditions. Additionally, technologies that minimize material intensity or increase material flexibility could provide benefits throughout the supply chain. Smart manufacturing technologies support interoperable data communications across the supply chains, providing benefits to the entire value chain. The energy, environmental, and national security impacts associated with the extraction, refinement, transportation, and processing of materials used in manufactured goods could be improved in many ways:

- Reducing the amount of bulk material needed to form a product
- Developing alternative materials that can be used in place of critical materials or other high-cost, high-energy commodities
- Increasing recycling and re-use of materials from end-of-life products
- Modifying manufacturing processes to enable the use of cleaner, more reliable, or more plentiful fuels or feedstocks

Table 6.9 lists significant recent federal investments in manufacturing technology areas with strong potential for life-cycle impacts. While life-cycle assessment is an important screening tool, it is not a comprehensive impact analysis methodology; a complete analysis must incorporate all environmental, societal, and economic burdens of a technology to avoid unwanted burden shifting.<sup>71</sup>

### 6.4.1 Manufacturing to Reduce Material Criticality

Manufacturing approaches to increase material flexibility, increase recycling, and minimize reliance on critical and costly materials can narrow the gap between current energy use and practical minimum energy requirements, will decouple manufacturing from the practical limitations of current processes, and will provide for life-cycle benefits.



**Table 6.9** Examples of Manufacturing Technologies with Strong Potential for Life-Cycle Impacts

Impact modality	Key topics	Major federal investments
Sustainable materials flows through the life cycle	<ul style="list-style-type: none"> <li>■ Critical materials and critical material alternatives</li> <li>■ Recycling and re-use</li> </ul>	<ul style="list-style-type: none"> <li>■ Critical Materials Institute (CMI), an energy innovation hub</li> <li>■ Rare Earth Alternatives in Critical Technologies for Energy (REACT) program</li> </ul>
Lightweight materials for use phase energy impacts	<ul style="list-style-type: none"> <li>■ Lightweight metals</li> <li>■ Low energy/low cost carbon fiber</li> <li>■ Thermosetting and thermoplastic polymer resins</li> <li>■ Joining and fabrication</li> <li>■ Recycling of lightweight structural materials</li> </ul>	<ul style="list-style-type: none"> <li>■ Institute for Advanced Composites Manufacturing Innovation (IACMI)</li> <li>■ Carbon Fiber Technology Facility (CFTF)</li> <li>■ Lightweight Innovations for Tomorrow (LIFT) consortium</li> </ul>
Advanced materials manufacturing for clean energy products	<ul style="list-style-type: none"> <li>■ Roll-to-roll processing</li> <li>■ Additive manufacturing</li> <li>■ Wide bandgap semiconductors</li> <li>■ Direct energy conversion devices</li> <li>■ Computational manufacturing</li> </ul>	<ul style="list-style-type: none"> <li>■ Manufacturing Demonstration Facility (MDF)</li> <li>■ Materials Genome Initiative (MGI) for Global Competitiveness</li> <li>■ National Additive Manufacturing Innovation Institute (“America Makes”)</li> <li>■ Next Generation Power Electronics National Manufacturing Innovation Institute (“PowerAmerica”)</li> <li>■ Digital Manufacturing and Design Innovation Institute (DMDII)</li> <li>■ Integrated Photonics Institute for Manufacturing Innovation (IP-IMI)</li> </ul>

### Critical Materials and Critical Material Alternatives

Specific materials enable clean energy technologies by virtue of their unique chemical and physical properties. As part of efforts to advance a clean energy economy, in 2010 and 2011 DOE authored a *Critical Materials Strategy* that examined the role of key materials in four specific clean energy technologies: photovoltaics, wind turbines, electric vehicles, and energy-efficient lighting.<sup>72</sup> The results of the DOE assessment are shown in Figure 6.11. Each material’s criticality was assessed by considering its importance to those clean energy applications, as well as supply challenges such as a small global market, lack of supply diversity, market complexities caused by co-production, and geopolitical risks. As an example, aggressive deployment goals for clean energy technologies contribute to the rising demand for rare earth permanent magnets using neodymium and dysprosium:

- An electric drive vehicle may use up to a kilogram of neodymium, and a wind turbine can contain several hundred kilograms of neodymium.<sup>73</sup>
- Industry trends drive materials criticality. For example, as the wind industry transitions toward turbines that are larger and more powerful,<sup>74</sup> the use of rare earth permanent magnets has increased to reduce the size and weight of the generators. Additionally, demand has increased for wind turbines that can operate at slower speeds, which can be achieved through a direct-drive arrangement that requires as much as several hundred kilograms of rare earth content per megawatt of power rating.<sup>75</sup>

- One study estimated that the demand for dysprosium and neodymium could increase by 700% and 2600%, respectively, over the next twenty-five years in a business-as-usual scenario.<sup>76</sup>

A secure, sustainable supply chain for these materials is needed to help enable invention, manufacturing and deployment of clean energy technologies in the United States. DOE's strategy for addressing this challenge has focused on three pillars. First, diversified global supply chains

diffuse supply risk, and the United States could simultaneously facilitate domestic extraction, processing and manufacturing while encouraging other nations to expedite alternative supplies. Second, the development of material and technology substitutes will serve to improve supply chain flexibility. Finally, recycling, re-use, and more efficient use will reduce the demand for newly extracted materials.<sup>77</sup>

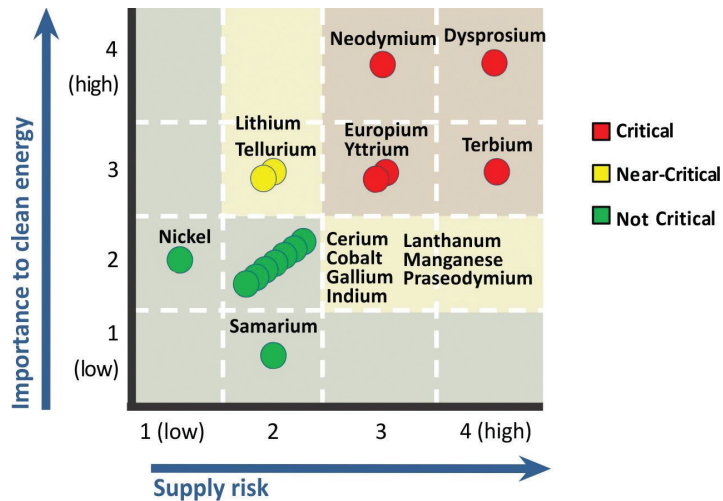
It is important to note that the criticality of a material is dynamic and depends on how "criticality" is defined, as evidenced by comparing the DOE *Critical Materials Strategy* with similar analyses.<sup>78</sup> Current efforts on critical materials at DOE are focused on rare earth elements, given their importance to wind energy, electric vehicles and energy-efficient lighting. Expanding the focus beyond these specific clean energy applications, materials such as tungsten, bismuth, and helium also require attention as they are essential to the manufacture of clean energy technologies, though not always physically present in the final products.<sup>79</sup> Additionally, materials such as rhenium and hafnium are essential to the superalloys used in high-temperature applications, such as natural gas turbine blades and components. Without such superalloys, the turbines operate at lower temperatures with lower efficiency.<sup>80</sup> When considering this wider array of technologies, numerous key elements provide unique properties for energy applications and face potential supply chain challenges, as shown in Table 6.10. Additional details and examples may be found in the *Critical Materials Technology Assessment*.

### Sustainable Manufacturing – Flow of Materials through Industry

Sustainable manufacturing<sup>81</sup> encompasses a wide range of systems issues, including energy intensity, carbon intensity, and use intensity. Energy considerations alone are insufficient to capture the full range of impacts. A more complete understanding can be gained by tracking how materials flow through manufacturing supply chains and where resources such as materials, water, and energy are used throughout product life cycles. Pursuing strategies to increase material efficiency will reduce the material use intensity of supply chains, and in turn provide additional opportunities for energy efficiency.

U.S. per capita materials consumption is estimated to have grown by 23%, and total material consumption by 57%, between 1975 and 2000.<sup>82</sup> Gutowski *et al.*<sup>83</sup> estimated that a 75% reduction in average energy intensity of material production is needed to meet the Intergovernmental Panel on Climate Change (IPCC) climate goals to reduce global energy use by half from 2000 to 2050. In 2005, the United States used nearly 20% of the

**Figure 6.11** Medium-Term (from 2015 to 2025) Criticality Matrix for Elements Important to Wind Turbines, Electric Vehicles, Photovoltaic Cells, and Fluorescent Lighting<sup>66</sup>



**Table 6.10** Key Elements for Energy-Related Technologies

Technology	Key elements
Permanent magnets (for wind turbines and electric vehicles)	Dysprosium, neodymium, praseodymium
Fluorescent lighting	Cerium, europium, lanthanum, manganese, terbium, yttrium
Light-emitting diodes (LEDs)	Cerium, europium, gallium, germanium, indium, lanthanum, nickel, silver, terbium, tin, yttrium
Photovoltaics	Gallium, indium, nickel, silver, tellurium, tin
Batteries (for electric vehicles and storage)	Cerium, cobalt, graphite, lanthanum, manganese, lithium, nickel, terbium, vanadium
Catalytic converters	Cerium, lanthanum, palladium, platinum, rhodium
Fuel cells	Cerium, cobalt, gadolinium, lanthanum, palladium, platinum, rhodium, yttrium
Gas turbines	Hafnium, rhenium, yttrium
Hydrogen electrolysis	Palladium, platinum, rhodium
Nuclear power	Cobalt, indium, gadolinium
Thermoelectrics	Antimony, bismuth, cerium, cobalt, lanthanum, lead, tellurium, ytterbium
Vehicle lightweighting	Gadolinium, magnesium, titanium

global primary energy supply and 15% of globally extracted materials, equivalent to 8.1 billion metric tons. At roughly 27 metric tons per person, U.S. per capita material use is higher than most high-income countries and is approximately double that of Japan and the United Kingdom.<sup>84</sup>

Material consumption reflects the input side of the equation. On the output side, the United States generated close to 2.7 billion metric tons of waste in 2000. This waste generation has increased 26% since 1975, with a 24% increase in harmful waste products (e.g., radioactive compounds, heavy metals, and persistent organic chemicals). It is estimated that 75% of carbon emissions are from scope 3 sources (i.e., indirect emissions from the extraction and production of materials, waste disposal, etc.),<sup>85</sup> indicating that the supply chain is a prime opportunity space for emissions reductions.

A fundamental problem with the way that products are designed and built today is that design for re-use is not typically a consideration. Consumer awareness of recycling and sustainability has helped to reduce demand for primary materials, but far more could be done if materials and products were designed with recycling and re-use in mind. Secondary (recycled) metals often require a fraction of the energy to process into usable materials than primary metals do. A comparison of energy demands for primary and secondary aluminum ingot production is shown in Table 6.11. Increased recycling of aluminum could provide savings of up to 52.4 MMBtu for every metric ton of primary aluminum replaced by secondary aluminum, although this strategy is currently limited due to the mixture of alloys in secondary aluminum.<sup>86</sup> Strategies for lightweighting, reduced yield loss, component re-use, extended product life, and more intense use also can result in decreased total demand.

Substantial energy and cost benefits can also be realized from technologies that allow goods to be produced using smaller quantities of raw materials than traditional manufacturing technologies. Additive manufacturing (3D printing), discussed in more detail in Section 6.2.2, is an important example. Since materials are deposited

layer-by-layer and only where needed, additive manufacturing processes create very little waste compared to machining and other fabrication processes. Additive manufacturing also offers the ability to use recycled materials in certain applications.<sup>87</sup> Product and product packaging design can also be optimized to reduce materials use and minimize waste.

**Table 6.11** Current Energy Demands for Primary and Secondary Aluminum Ingot

	Primary aluminum (MMBtu/MT)	Secondary aluminum (MMBtu/MT)
Manufacturing facility energy demand (production only)	57.2	4.8
Supply chain energy demand (extraction through production)	117	22.7

In the areas of both critical materials management, as well as in this broader topic of sustainable manufacturing, complementary social science research can identify strategies to increase rates of material recovery so as to reduce virgin material requirements, costs, and energy consumption. Even modest increases in recovery rates could help stabilize prices of critical materials and mitigate environmental impacts of energy-intensive materials.

### 6.4.2 Advanced Materials Manufacturing for Clean Energy Products

Advanced materials manufacturing encompasses innovative materials and processes—plus the devices and systems that incorporate them—that can lead to step-change improvements in energy, emissions, and functionality compared to the historical development trajectories of conventional materials. Transformational next-generation materials and products could narrow the gap between current energy use and practical minimum energy requirements in the manufacturing sector, and could enable life-cycle benefits in the other energy consuming and energy generation sectors.

#### Direct Thermal Energy Conversion Materials, Devices and Systems

Direct energy conversion (DEC) is a broad category of materials, devices, and systems that convert energy from one form to another without intermediate steps (such as a working fluid). Many clean energy technologies are based on direct energy conversion. For example, LEDs directly convert electricity to light, taking advantage of unique photonic properties of specific materials (e.g., gallium nitride for white LEDs). Solar photovoltaics, which convert solar energy directly to electricity, are another example of direct energy conversion devices. Solar photovoltaic efficiencies have improved dramatically since the discovery of the solar cell, with many cells doubling, tripling or quadrupling in efficiency over the past forty years.<sup>88</sup>

With process heating waste heat losses in the United States exceeding 2,500 TBtu annually<sup>89</sup> (see *Waste Heat Recovery Systems* in Section 6.3.1), the manufacturing sector could derive benefits from a class of DEC technologies that convert thermal energy to electricity. Technologies for direct thermal energy conversion are in various stages of maturity, and include phase-change-material engine, magnetocaloric, thermo-acoustic-piezoelectric, thermionic, thermophotovoltaic, and thermoelectric generators.

Thermoelectric systems, in particular, are among the most promising heat-to-electricity energy conversion technologies. Thermoelectric systems convert heat energy to electricity and vice versa, and can be used in applications ranging from waste heat recovery to refrigeration. While thermoelectric heat pumps for heating and cooling applications are used in commercial applications such as optical equipment and automotive seat heaters, thermoelectric generators (TEGs) have shown limited commercial market penetration in waste heat-to-power conversion due to high system costs compared to conventional power generation technologies. At present, the thermoelectric market for energy harvesting has been limited primarily to military and aerospace markets where reliability, quiet operation, and remote operability are critical.<sup>90</sup> If the installed system cost of thermoelectric

generation were reduced to about \$1 per watt,<sup>91</sup> thermoelectric generation could be competitive with the current average U.S. industrial electricity price of \$0.0682 per kilowatt hour (kWh).<sup>92</sup> Pathways to achieving this \$1 per watt target include the development/identification of lower-cost materials and more favorable manufacturing techniques enabling higher production volumes. Material cost is significantly high in TEGs, typically accounting for 50%-80% to the overall thermoelectric system generation cost.<sup>93</sup> Furthermore, TEG manufacturing techniques still consist of manual “pick-and-place” (hand loading) operations, contributing to high production costs.

Research and development focused on driving improvements in the capabilities and costs of thermoelectric materials could greatly benefit TEG performance. The most common thermoelectric materials today are alloys of chalcogenides with a dimensionless figure of merit value (ZT) of around 1<sup>94</sup> and an average overall efficiency of 5% for a temperature difference of 200°C–250°C.<sup>95</sup> High-ZT materials developed in recent years include skutterudites, calthrates, Half-Heuslers, and oxides such as cobaltites and perovskites; these systems have shown efficiencies as high as 16%.<sup>96</sup> Further, the use of three-stage cascade-type thermoelectric modules could yield an overall thermoelectric efficiency of 20% for a heat transfer rate of 400 kW/m<sup>2</sup>.<sup>97</sup> Introduction of automation into product assembly will improve the reliability of the TEGs and ultimately drive down the costs for producing these devices. Promising fabrication techniques include additive manufacturing and wafer processing (similar to that used in integrated circuit manufacturing). Challenges associated with these techniques include kerf (wafer cutting) losses and scalability to production volumes.

Additional research is also needed to improve heat transfer capabilities in thermoelectric generators. This includes cost optimization of heat exchangers that collect and transfer heat to cooling water, but it also applies to heat transfer within the module. Studies to co-optimize the thermal and electrical properties of the whole TEG system while maintaining its mechanical integrity are also important.<sup>98</sup> Materials testing standards and device testing procedures are also critical to the commercialization of thermoelectrics as power generation devices. System-level TEG demonstrations in near-term potential applications—similar to those demonstrated in Japanese steel plants<sup>99</sup>—would help to establish the efficacy of TEG waste heat recovery for industrial processes. Table 6.12 estimates the quantities of waste heat generated by several energy-intensive manufacturing industries on a yearly basis and the amount of energy that could be recovered with TEG technology based on an assumed efficiency of 2.5%. The energy savings opportunity could be considerably enhanced with advanced materials, better coupling through improved heat exchangers, and other technology improvements.

### Materials for Harsh Service Conditions

The physical limitations of materials in demanding environments have long constrained engineers in the design of innovative new products and technologies. Aggressive service environments can involve high temperatures or thermal cycling, high pressures, corrosive chemicals, dust and particulates, mechanical wear, neutron irradiation, and hydrogen attack. These aggressive environments—and the associated materials durability challenges—are common across multiple applications and sectors. To meet stringent application demands for future products that will provide energy savings, emissions reductions, and other benefits requires new materials and new materials processing solutions. Examples include the following:

- **Ultra-supercritical steam turbines:** Gas and steam turbine power plants could achieve higher efficiencies if they operated at higher inlet temperatures, but operating temperatures are constrained by the thermal stability of existing turbine and boiler-tube alloys at high temperatures and pressures.
- **Waste heat recovery in harsh environments:** There are significant opportunities to recover waste heat from industrial process heating operations (see *Waste Heat Recovery Systems* in Section 6.3.1).

**Table 6.12** Estimate of Waste Heat that Could be Recovered with Thermoelectric Technology for Various Process Industries

Manufacturing process industry	Process heating energy use (TBtu/yr) <sup>100</sup>	Process heating energy losses (TBtu/yr) <sup>101</sup>	Estimated recoverable heat range (TBtu/yr) <sup>102</sup>	Estimated thermoelectric potential (TBtu/yr) <sup>103</sup>	Estimated thermoelectric potential (GWh/yr) <sup>104</sup>
Petroleum refining	2,250	397	40–99	1–2	291–727
Chemicals	1,460	328	33–82	1–2	240–601
Forest products	980	701	70–175	2–4	513–1,280
Iron and steel	729	334	33–84	1–2	245–612
Food and beverage	518	293	29–73	1–2	215–537
Glass	161	88	9–22	0–1	64–161
Other manufacturing	1,110	426	43–107	1–3	312–780
<b>All manufacturing</b>	<b>7,200</b>	<b>2,570</b>	<b>257–642</b>	<b>6–16</b>	<b>1,880–4,700</b>

However, many sources of industrial waste heat are unrecoverable because existing heat exchanger alloys and power conversion materials are incompatible with corrosive, high-flow-rate, and/or high-temperature flue gases. Improved heat transfer equipment and hot gas cleanup operations would benefit from materials development.

- **Corrosion-resistant pipelines:** Corrosion of iron and steel pipelines can cause leaking of natural gas into the environment, leading to wasted energy, explosion hazards, and methane emissions. Pipeline corrosion has accounted for more than 1,000 significant pipeline incidents over the past twenty years, directly resulting in twenty-three fatalities and more than \$822 million in property damage.<sup>105</sup>
- **Irradiation-resistant nuclear fuel cladding:** Conventional nuclear fuel cladding materials have very good performance at design conditions but leave room for improvement at the very high temperature steam environments possible in beyond-design-basis accidents.<sup>106</sup> Irradiation-resistant, phase-stable nuclear fuel cladding materials with improved performance at beyond-design-basis accident conditions could mitigate accidents at nuclear facilities.

Energy and emissions savings opportunities for these selected application areas are estimated in Table 6.13. Broadly, research needs can be roughly divided into three crosscutting materials challenges. Applications requiring material stability in extreme environments, such as ultra-high pressure or ultra-high temperature, require phase-stable materials. Research in functional surfaces is needed to develop advanced coatings and surface treatments that provide outstanding material properties, such as corrosion and wear resistance. Embrittlement-resistant materials are needed to resist material aging effects in certain extreme environments, including exposure to hydrogen (which can cause hydrogen embrittlement) and radiation (which can cause neutron embrittlement and radiation-induced swelling).

### Wide Bandgap Semiconductors for Power Electronics

Promising WBG semiconductor materials for power electronics applications include silicon carbide (SiC) and gallium nitride (GaN). Of these two materials, SiC is relatively more mature for power electronics applications. Both materials offer the benefits of higher temperature, frequency and voltage operation compared to conventional silicon (Si) devices, enabling smaller, lighter, and higher efficiency power electronics. GaN

**Table 6.13** Materials Challenges and Energy Savings Opportunities for Selected Harsh Service Conditions Application Areas

Application area	Materials challenges						Estimated annual energy savings opportunity (TBtu)	Estimated annual GHG emissions savings opportunity (million tons CO <sub>2</sub> -eq.)
	High pressure stability	High temperature or thermal cycling stability	Corrosion or fouling resistance	Wear or erosion resistance	Resistant to neutron embrittlement	Resistant to hydrogen embrittlement		
Advanced ultra-supercritical steam turbines <sup>107</sup>	X	X	X	X			859	88.2
Waste heat recovery equipment for harsh environments <sup>108</sup>		X	X	X			247	14.5
Corrosion-resistant gas pipelines <sup>109</sup>	X		X			X	67	28.6
Irradiation-resistant nuclear fuel cladding <sup>110</sup>	X	X			X		n/a <sup>111</sup>	34.7
<b>Total energy and emissions savings opportunities</b>							<b>1,170</b>	<b>166</b>

transistors are likely to dominate in 200V–900V applications with power levels up to 10kW. These include power supplies for data farms, laptops, TVs, and solar micro and string converters. SiC switches and diodes are expected to be a better fit for higher power use in 900V–15,000V applications, including central solar, automotive, and fuel cell inverters, quick chargers, medium-voltage motor drives, and distribution grid-based power flow controllers.

If high adoption of these technologies is realized in just the limited set of applications shown in table 6.14, about 40,000 GWh (137 TBtu) of electrical power savings in the United States could be achieved annually. If WBG semiconductors could capture the estimated 10% worldwide variable frequency drive market, global energy savings of 117,000 GWh/year (400 TBtu/year) could be achieved. See the *Wide Bandgap Semiconductors for Power Electronics* Technology Assessment for further details.

The current low adoption rate of WBG semiconductors for power electronics applications can be primarily attributed to the high costs of substrate and epitaxial materials compared to conventional Si devices. These high costs are tied to small production volumes and high manufacturing costs. With higher volume production, it is anticipated that WBG substrate and epitaxial deposition costs can be reduced to \$800 per six-inch wafer. Using the open commercial foundry model, analysis shows that a 1200V/20A SiC metal-oxide-semiconductor field-effect transistor (MOSFET) die with an on-state resistance of 5mΩ/cm<sup>2</sup> can be fabricated in a high-volume six-inch foundry for \$0.037/amp. As the market increases and the inevitable move is made to eight-inch substrates, it is anticipated that the price can reach \$0.01/amp<sup>116</sup>—less than the current cost of Si devices (\$0.10/amp). 10kV–15kV WBG devices will enable more-efficient industrial motor drives and power controllers for grid modernization.

## Computational Manufacturing and the Materials Genome Initiative

At present, the time frame for incorporating new classes of materials into applications is remarkably long—typically about ten to twenty years from initial research to first use.<sup>112</sup> The prolonged time frame for materials to transition from discovery to market is due in part to traditional materials research and development methods, which rely largely on scientific intuition and trial-and-error experimentation. Design and testing of materials is typically performed through time-consuming and repetitive experiment and characterization loops. Some experiments could potentially be performed virtually using powerful and accurate computational tools, but physics-based models with the required accuracy are not available off-the-shelf for most applications. Custom models require significant investment in specialized software and dedicated engineering talent.

The application of computational manufacturing techniques in material and process design has the potential to greatly reduce the development time of advanced materials. “Predictive theory and modeling of materials” employs a combination of physical theory, advanced computer models, and vast materials properties databases to accelerate the design of a new material with application-specific properties by optimizing composition and processing to develop the desired structure and properties. Applications could include the synthesis and development of an extremely tough, lightweight composite for a wind turbine blade or a high-surface-area catalyst for a proton exchange membrane fuel cell. Computational modeling and simulation holds great promise for accelerating scale-up and minimizing the “trial and error” approach of traditional manufacturing, which can lock in inefficient or suboptimal systems for decades. A challenge for computational modeling of materials is the lack of reliable simulation models to predict the impact of a manufacturing process on the material’s mechanical properties and functional behavior.

Developing the next generation of computational tools, databases and experimental techniques for materials research is one of the primary goals of the multiagency Materials Genome Initiative (MGI).<sup>113</sup> The MGI aims to halve the amount of time required from conception of a new material to implementation by increasing transparency of data and creating opportunities for feedback between development stages. Similar computational initiatives are underway for discovery and manufacturing process planning within specific industries.<sup>114</sup>

**Table 6.14** Energy Savings Opportunities for Selected Application Areas<sup>115</sup>

Application area	Estimated annual energy savings opportunity	
	(TBtu)	(GWh)
Laptops and tablets	8	2,300
Cell phones	19	5,600
Data centers	37	10,800
Variable frequency drive motors	38	11,100
Renewable power generation	36	10,600
<b>Total</b>	<b>137</b>	<b>40,100</b>



## Composite Materials

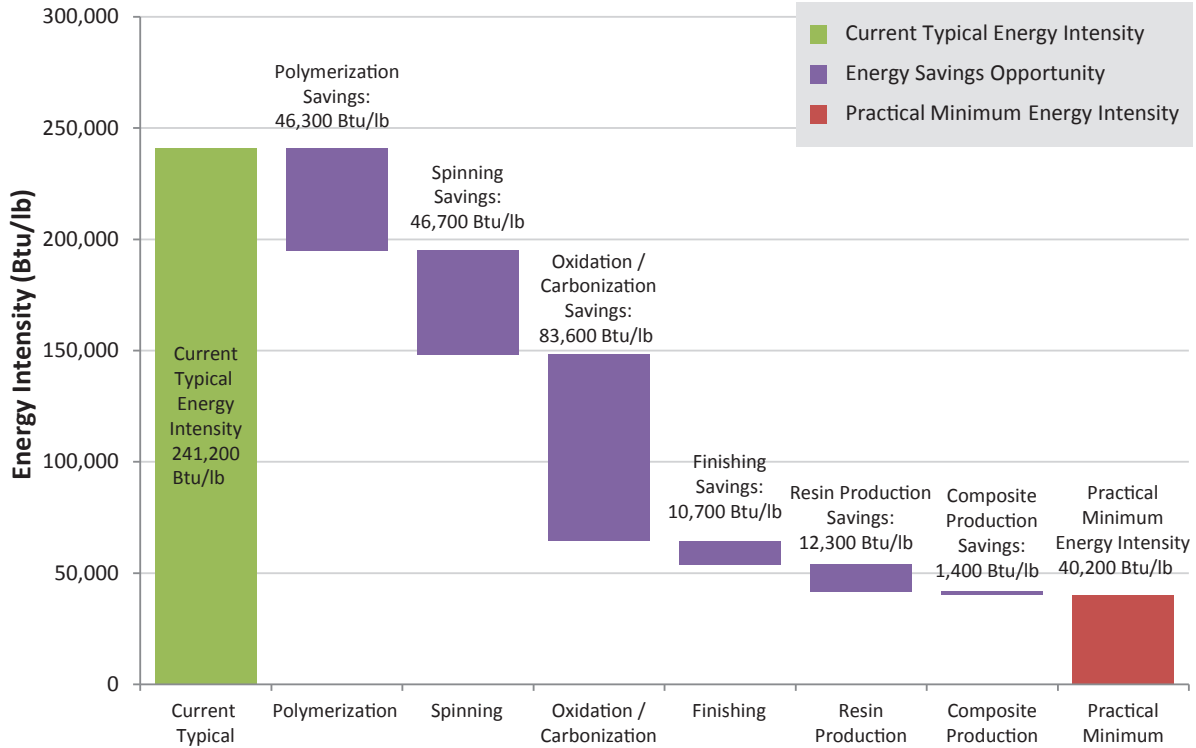
Lightweight, high-strength, and high-stiffness composite materials have been identified as a key crosscutting technology in U.S. clean energy manufacturing, with the potential to reinvent an energy efficient transportation sector, enable efficient power generation, and increase renewable power production.<sup>118</sup> In order to meet this potential, advanced manufacturing techniques are required that will enable an expansion of cost-competitive production at commercial volumes and performance. Technology advances and research in manufacturing—from constituent materials production to final composite structure fabrication—are needed to reach cost and performance targets at production volumes and transform supply chains for these and associated markets.<sup>119</sup> High priority challenges include high costs, low production speeds (long cycle times), high manufacturing energy intensity of composite materials, recyclability challenges, and a need to improve design, modeling, and inspection tools for composites to meet commercial and regulatory demands.

A subcategory of composite materials, fiber-reinforced polymer (FRP) composites are made by combining a polymer resin matrix with strong, reinforcing fibers such as glass or carbon. A number of applications benefit specifically from carbon fiber reinforced polymer (CFRP) composites, which offer a higher strength-to-weight ratio and stiffness-to-weight ratio than many structural materials. These lightweight composites, when utilized appropriately and with further technology advancements, could provide use phase energy and carbon emissions savings from opportunities such as fuel savings as gained by introduction of lighter weight vehicles, efficient operation at a lower installed cost in wind turbines, and use of compressed gas tanks for natural gas and hydrogen fuel storage.

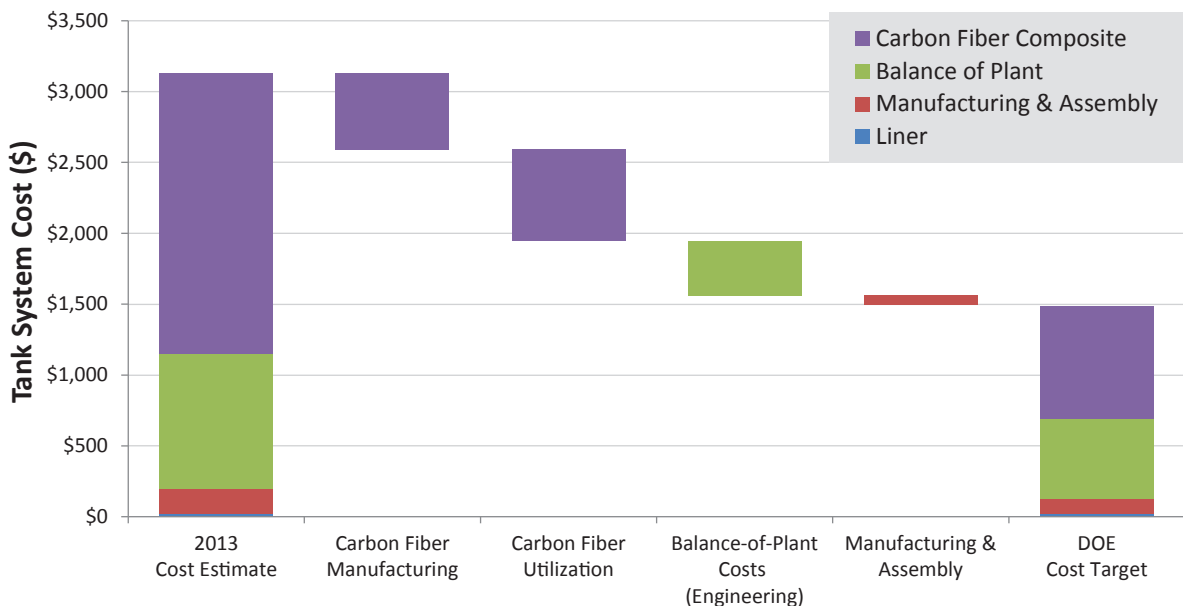
The Corporate Average Fuel Economy (CAFE) standard targeting 54.5 mpg by 2025 is driving increasing industrial interest in a range of lightweighting technologies, including high-performance composites, as a means to achieve required mass reductions. A 10% reduction in vehicle mass can yield a 6%–8% reduction in fuel consumption.<sup>120</sup> CRFP composites have a weight savings potential in the range of 50%–60%, but they are very energy intensive to manufacture and one and one-half to five times more expensive than conventional steel.<sup>121</sup> With major advancements in the next fifteen years, the cost is expected to drop from \$10 per pound to \$5 per pound for composite materials suitable for the automotive sector.<sup>122</sup> Manufacturing speed is critical, particularly for high volume applications like the automotive sector where the capability to produce more than 100,000 parts per year at cycle times of less than three minutes is needed. One current technology used today for carbon fiber composites in low- to mid-production volume vehicle parts has a cycle time of less than twenty minutes,<sup>123</sup> and while cycle times under two minutes have been shown at laboratory scale,<sup>124</sup> significant effort is needed to develop full scale capabilities. Furthermore, to fully realize use phase benefits in vehicle lightweighting, the energy intensity of CFRPs must be addressed. Figure 6.12 shows potential energy savings opportunities in the fabrication of one pound of CFRP composite, based on a review of state-of-the-art and RDD&D technologies under development.

Another application for fiber-reinforced composites is compressed gas storage tanks. Analysis has shown that fuel cell electric vehicles using hydrogen can reduce oil consumption in the light-duty vehicle fleet by more than 95% when compared with today's gasoline internal combustion engine vehicles, by more than 85% when compared with advanced hybrid-electric vehicles using gasoline or ethanol, and by more than 80% when compared with advanced plug-in hybrid electric vehicles.<sup>124</sup> However, the high costs of hydrogen fuel storage tanks are a barrier to deployment of fuel cell electric vehicles. Figure 6.13 shows a potential cost reduction strategy for a composite overwrapped pressure vessel (COPV) hydrogen storage tank. CFRP composites currently dominate the system cost, and reductions in these costs could help accelerate deployment of energy-efficient fuel cell electric vehicles.

**Figure 6.12** Energy Savings Opportunities for One Pound of Carbon Fiber Reinforced Polymer Composite, Broken Down by Subprocess. Energy intensities and savings opportunities are based on a 40% epoxy/60% carbon fiber (by weight) composite part fabricated via resin transfer molding.<sup>125</sup> Energy intensity depends on the ratio of fibers to polymer, the type of resin and manufacturing process chosen.



**Figure 6.13** Potential Cost Reduction Strategy for Composite Overwrapped Pressure Vessels to Meet the 2020 U.S. DRIVE Cost Target.<sup>127</sup> Innovations in carbon fiber manufacturing and use can play key roles in reducing the cost to achieving DOE's ultimate cost target.



## Open Commercial Foundry Model to Accelerate WBG Power Electronics Impact

The relatively high costs of WBG power electronics devices are tied to small production volumes and high manufacturing costs. A capital investment of approximately \$100 million is needed for a dedicated foundry to fabricate WBG semiconductors, and unless the market exists to fully utilize the foundry, this initial investment may not be recovered. A secondary effect of dedicated foundries is that the technology is essentially closed to new companies and researchers.

The open commercial foundry model concept is based upon utilizing existing six- and eight-inch Si foundries in the U.S. and repurposing their idle plant capacity to produce WBG devices. These six- and eight-inch foundry lines are becoming available for repurposing as the Si chip industry transitions to state-of-the-art twelve-inch Si wafers. Given that approximately 90% of the processes needed to manufacture WBG chips are the same processes as for Si chips, an investment of approximately \$10M to establish the required additional processing steps in an existing silicon foundry would enable the production of WBG devices at significantly lower cost compared to establishing a dedicated WBG foundry. These open foundries would then be open to researchers, universities, and small companies, similar to the Silicon Metal Oxide Semiconductor Implementation System (MOSIS) foundry service, which facilitates the sharing of integrated circuit fabrication costs among multiple users. Educational activities can be promoted with open foundries through the development of classes concentrating on the specifics of WBG chip design and process flow steps, knowledge which can then be implemented directly at the foundry. In addition, establishing a mechanism to enable new companies to form with significantly reduced capital investment and opening the foundries to university students will help to expand the U.S. workforce and expertise in this critical technology area, helping to create an ecosystem for power electronics manufacturing in the United States. This open commercial concept is currently being explored by the DOE PowerAmerica Institute that was established at North Carolina State University in 2014.<sup>117</sup>

Composite materials offer the potential for energy savings but have cost, energy, production and recyclability challenges that need to be further addressed through advanced manufacturing RDD&D. Addressing these and other technical challenges may enable U.S. manufacturers to capture a larger share of the high-value-added composites market segment and could support domestic manufacturing competitiveness.

### 6.5 Conclusion

The systems framework outlined in this chapter reveals opportunities to improve the energy and emissions footprint of the manufacturing sector, highlighting technologies that can enable energy and environmental life-cycle impacts and those that can provide a competitive advantage over practices widely in use. Opportunities were informed by a series of fourteen manufacturing Technology Assessments (see Table 6.15). These technologies span a range of maturities across the RDD&D innovation spectrum, but all have the potential to transform the manufacturing sector and the energy economy through higher manufacturing throughput, increased energy efficiency, and positive life-cycle impacts.

This chapter demonstrates that opportunities extend beyond the industrial sector. The manufacture of clean energy products impacts the entire energy economy, with cross-sectoral and life-cycle energy benefits. Opportunities beyond the plant boundaries include improvements to the networks of facilities, business processes, and operations involved in moving materials through industry, from extraction of raw materials to the production of finished goods. The manufacturing sector also supports U.S economic growth, as a strong manufacturing base can lead to competitive advantages gained through manufacturing innovations.

**Table 6.15** Manufacturing Technologies Assessed in QTR Chapter 6: Innovating Clean Energy Technologies in Advanced Manufacturing

Technology Assessment	Overview of key opportunities
Additive Manufacturing	In comparison with conventional subtractive manufacturing techniques, additive (3D printing) techniques can reduce materials waste, eliminate production steps, and enable new products that cannot be fabricated via conventional methods.
Advanced Materials Manufacturing	New-paradigm materials manufacturing processes, such as electrolytic metal production processes and electric field processing, are enabling advanced materials with superior properties or lower energy requirements than prior techniques. Further, computational modeling and data exchange is accelerating the process of new materials discovery by minimizing trial and error.
Advanced Sensors, Controls, Platforms and Modeling for Manufacturing	Automation, modeling and sensing technologies enable real-time management of energy, productivity and costs at the level of machine, factory, and enterprise for crosscutting impacts.
Combined Heat and Power Systems	The concurrent production of electricity and useful thermal energy from a single energy source can reduce fuel requirements compared to generating power and heat separately. CHP generation is typically performed onsite, increasing resiliency.
Composite Materials	Structural composite materials could provide energy and environmental benefits in lightweighting applications such as vehicles, wind turbines, and gas storage.
Critical Materials	Many clean energy technologies rely on critical materials (e.g., neodymium in a wind turbine permanent magnet); sustainable supply chains will advance these technologies.
Direct Thermal Energy Conversion Materials, Devices, and Systems	Direct thermal energy conversion technologies convert energy from one form to another without intermediate steps; promising heat-to-electricity conversion technologies like thermoelectrics can be used in applications ranging from waste heat recovery to refrigeration.
Materials for Harsh Service Conditions	Opportunities include higher-temperature, higher-efficiency power plants; corrosion-resistant pipelines for natural gas and hydrogen delivery; improved waste heat recovery in corrosive environments; and improved nuclear fuel claddings.
Process Heating	Process heating accounts for nearly two-thirds of onsite manufacturing energy; opportunities to reduce energy consumption include lower-energy processing (e.g., microwave heating), integrated systems, waste heat recovery, and advanced controls.
Process Intensification	Process intensification techniques such as the integration of multiple unit operations into a single piece of equipment and modular system design can improve manufacturing throughput, quality, and energy efficiency.
Roll-to-Roll Processing	This fabrication technique enables many 2D clean energy products, such as flexible electronics for solar panels and membranes for low-energy separations.

**Table 6.15** Manufacturing Technologies Assessed in QTR Chapter 6: Innovating Clean Energy Technologies in Advanced Manufacturing (continued)

Technology Assessment	Overview of key opportunities
Sustainable Manufacturing - Flow of Materials through Industry	Material flow analyses reveal expanded technology opportunities; for example, recycled materials can require much less energy to process than primary materials, but to fully realize these benefits requires a broader systems approach, products designed for re-use, and technologies that enable greater use of secondary materials.
Waste Heat Recovery Systems	Manufacturing waste heat can be captured and re-used by redirecting waste streams for use in another thermal process or by converting the waste heat to electricity.
Wide Bandgap Semiconductors for Power Electronics	Wide bandgap semiconductors can enable smaller, lighter, and higher-efficiency power electronics compared to silicon-based devices.



## Chapter 6: Innovating Clean Energy Technologies in Advanced Manufacturing

# Technology Assessments

- 6A** Additive Manufacturing
- 6B** Advanced Materials Manufacturing
- 6C** Advanced Sensors, Controls, Platforms and Modeling for Manufacturing
- 6D** Combined Heat and Power Systems
- 6E** Composite Materials
- 6F** Critical Materials
- 6G** Direct Thermal Energy Conversion Materials, Devices, and Systems
- 6H** Materials for Harsh Service Conditions
- 6I** Process Heating
- 6J** Process Intensification
- 6K** Roll-to-Roll Processing
- 6L** Sustainable Manufacturing - Flow of Materials through Industry
- 6M** Waste Heat Recovery Systems
- 6N** Wide Bandgap Semiconductors for Power Electronics

[See online version.]

## Supplemental Information

- Competitiveness Case Studies
- Public-Private Consortia and Technology Transition Case Studies

[See online version.]

## Endnotes

- <sup>1</sup> Industrial energy consumption is diverse. See industry sector energy supply shown in Chapter 1, Figures 1.3b.
- <sup>2</sup> EIA. “Annual Energy Review.” April 2014, Table 2.1. Available at: <http://www.eia.gov/totalenergy/data/monthly/archive/00351504.pdf>. EIA. “2010 Manufacturing Energy Consumption Survey (MECS),” Table 1.2. Available at: <http://www.eia.gov/consumption/manufacturing/data/2010/>. “Manufacturing Energy and Carbon Footprints (2010 MECS),” U.S. DOE, Office of Energy Efficiency & Renewable Energy. Available at: <http://energy.gov/eere/amo/manufacturing-energy-and-carbon-footprints-2010-mecs>. Note: Numbers may not add up correctly owing to independent rounding.
- <sup>3</sup> This goal is consistent with voluntary goals for industrial energy intensity laid out in the Energy Policy Act (EPAAct) of 2005, Public Law 109-58, August 8, 2005 (119 STAT 594). Available at: [http://energy.gov/sites/prod/files/2013/10/f3/epact\\_2005.pdf](http://energy.gov/sites/prod/files/2013/10/f3/epact_2005.pdf).
- <sup>4</sup> For more details, see the “Energy Bandwidth Studies.” Available at: <http://www.energy.gov/eere/amo/energy-analysis-sector>.
- <sup>5</sup> “Sankey Diagram of Energy Flow in U.S. Manufacturing.” U.S. DOE Office of Energy Efficiency & Renewable Energy. Available at: <http://energy.gov/eere/amo/sankey-diagram-energy-flow-us-manufacturing>. Note: Electricity generation includes electricity generated from off-site sources, including coal- and natural-gas-fired power plants, nuclear power plants, and off-site renewable energy sources.
- <sup>6</sup> “Manufacturing Energy and Carbon Footprints (2010 MECS).” U.S. DOE Office of Energy Efficiency & Renewable Energy. Available at: <http://energy.gov/eere/amo/manufacturing-energy-and-carbon-footprints-2010-mecs>.
- <sup>7</sup> “Manufacturing Energy and Carbon Footprints (2010 MECS).” U.S. DOE Office of Energy Efficiency & Renewable Energy. Available at: <http://energy.gov/eere/amo/manufacturing-energy-and-carbon-footprints-2010-mecs>.
- <sup>8</sup> “Manufacturing Energy and Carbon Footprints (2010 MECS).” U.S. DOE Office of Energy Efficiency & Renewable Energy. Available at: <http://energy.gov/eere/amo/manufacturing-energy-and-carbon-footprints-2010-mecs>.
- <sup>9</sup> “Sankey Diagram of Process Energy Flow in U.S. Manufacturing.” U.S. DOE Office of Energy Efficiency & Renewable Energy. Available at: <http://energy.gov/eere/amo/sankey-diagram-process-energy-flow-us-manufacturing-sector>.
- <sup>10</sup> Process heating operations, applications, and temperature ranges were drawn from the following sources:
  - “Energy Use, Loss, and Opportunities: U.S. Manufacturing and Mining.” Prepared by Energetics Inc. for the U.S. DOE Office of Energy Efficiency and Renewable Energy Industrial Technologies Program, 2004. Available at: [http://energy.gov/sites/prod/files/2013/11/f4/energy\\_use\\_loss\\_opportunities\\_analysis.pdf](http://energy.gov/sites/prod/files/2013/11/f4/energy_use_loss_opportunities_analysis.pdf).
  - “Improving Process Heating System Performance: A Sourcebook for Industry.” U.S. DOE Office of Energy Efficiency and Renewable Energy, 2nd edition, 2007. Available at: [http://www1.eere.energy.gov/manufacturing/tech\\_assistance/pdfs/process\\_heating\\_sourcebook2.pdf](http://www1.eere.energy.gov/manufacturing/tech_assistance/pdfs/process_heating_sourcebook2.pdf).
  - For the 2002 energy breakdown by process heating equipment category, see Chapas, R. B.; Colwell, J. A. “Industrial Technologies Program Research Plan for Energy-Intensive Process Industries.” Prepared by Pacific Northwest National Laboratory for DOE, 2007. Available at: [http://www1.eere.energy.gov/manufacturing/pdfs/itp\\_research\\_plan.pdf](http://www1.eere.energy.gov/manufacturing/pdfs/itp_research_plan.pdf). To estimate the 2010 energy breakdown, 2002 energy use was scaled based on the “2010 Manufacturing Energy and Carbon Footprints (2010 MECS). Available at: <http://energy.gov/eere/amo/manufacturing-energy-and-carbon-footprints-2010-mecs>. Engineering judgment was used to map process heating and steam equipment to the nine major process heating categories shown in the table.
- <sup>11</sup> “Manufacturing Energy and Carbon Footprints (2010 MECS).” U.S. DOE Office of Energy Efficiency & Renewable Energy. Available at: <http://energy.gov/eere/amo/manufacturing-energy-and-carbon-footprints-2010-mecs>.
- <sup>12</sup> Leonelli, C.; Mason, T. J. “Microwave and Ultrasonic Processing: Now a Realistic Option for Industry.” *Chemical Engineering and Processing*, 49, 2010; pp. 885-990.
- <sup>13</sup> Chapas, R. B.; Colwell, J. A. “Industrial Technologies Program Research Plan for Energy-Intensive Process Industries.” Prepared by Pacific Northwest National Laboratory for DOE, 2007. Available at: [www.efce.info/efce\\_media/-p-531.pdf](http://www.efce.info/efce_media/-p-531.pdf). Energy and emissions savings correspond to 2030 projections in the report. Opportunities greater than 100 TBtu have been tabulated; see the report for additional opportunities.
- <sup>14</sup> “Manufacturing Energy and Carbon Footprints (2010 MECS),” U.S. DOE Office of Energy Efficiency & Renewable Energy. Available at: <http://energy.gov/eere/amo/manufacturing-energy-and-carbon-footprints-2010-mecs>. Note: The proportion of manufacturing electricity indicated (68%) includes electricity for facility HVAC in addition to electricity for machine drive and process cooling and refrigeration as shown in Figure 6.5.
- <sup>15</sup> “Manufacturing Energy and Carbon Footprints (2010 MECS).” U.S. DOE Office of Energy Efficiency & Renewable Energy. Available at: <http://energy.gov/eere/amo/manufacturing-energy-and-carbon-footprints-2010-mecs>. Note: The on-site system losses stem from the electricity portion of process cooling and refrigeration and facility HVAC in addition to all energy for machine drive.
- <sup>16</sup> “Manufacturing Energy and Carbon Footprints (2010 MECS).” U.S. DOE Office of Energy Efficiency & Renewable Energy. Available at: <http://energy.gov/eere/amo/manufacturing-energy-and-carbon-footprints-2010-mecs>. Note: Table 6.3 includes the electricity portion of process cooling and refrigeration and facility HVAC in addition to all energy in the machine drive category shown in Figure 6.5. The GWh values were calculated based on an energy-equivalent basis to the TBtu values shown; a portion of the machine drive energy derives from fuel and steam use.
- <sup>17</sup> “U.S. Adoption of High-Efficiency Motors and Drives: Lessons Learned.” Duke University Center on Globalization, Governance & Competitiveness. Available at: [http://www.cgcc.duke.edu/pdfs/CGGC-Motor\\_and\\_Drives\\_Report\\_Feb\\_25\\_2010.pdf](http://www.cgcc.duke.edu/pdfs/CGGC-Motor_and_Drives_Report_Feb_25_2010.pdf).
- <sup>18</sup> “Improving Motor and Drive Performance.” U.S. DOE Office of Energy Efficiency and Renewable Energy. Available at: [http://www.energy.gov/sites/prod/files/2014/04/f15/amo\\_motors\\_sourcebook\\_web.pdf](http://www.energy.gov/sites/prod/files/2014/04/f15/amo_motors_sourcebook_web.pdf).

- <sup>19</sup> Baldwin, S.F. “The Materials Revolution and Energy-Efficient Electric Motor Drive Systems.” *Annual Review of Energy*, Vol. 13, 1988.
- “United States Industrial Electric Motor Systems Market Opportunities Assessment.” Prepared for the U.S DOE Office of Industrial Technologies and Oak Ridge National Laboratory by Xenergy Inc., December 1998 (updated December 2002). Available at: <http://cms.doe.gov/eere/amo/us-doe-motor-system-market-assessment>.
- <sup>20</sup> Wang, P.; Goel, L.; Liu, X.; Choo, F. H. “Harmonizing AC and DC.” *IEEE Power & Energy Magazine*, May/June 2013. Available at: <http://magazine.ieee-pes.org/files/2013/04/2245587.pdf>.
- Baran, M. E.; Mahajan, N. R. “DC Distribution for Industrial Systems: Opportunities and Challenges.” *IEEE Trans. Industry Appl.*, 39, 2003; p. 1596.
- <sup>21</sup> U.S. DOE Office of Energy Efficiency and Renewable Energy (EERE). “Next Generation Electric Machines: Megawatt Class Motors.” Funding Opportunity Announcement (FOA) Number DE-FOA-0001208, issued March 18, 2015. Available at: <http://www.energy.gov/eere/amo/articles/funding-opportunity-next-generation-electric-machines-megawatt-class-motors>.
- <sup>22</sup> “Manufacturing Energy and Carbon Footprints (2010 MECS).” U.S. DOE Office of Energy Efficiency & Renewable Energy. Available at: <http://energy.gov/eere/amo/manufacturing-energy-and-carbon-footprints-2010-mecs>
- <sup>23</sup> “European Roadmap for Process Intensification.” *Creative Energy*, 2007.
- <sup>24</sup> “Bandwidth Study on Energy Use and Potential Energy Saving Opportunities in U.S. Chemical Manufacturing. Prepared by Energetics Inc. for the U.S. DOE Advanced Manufacturing Office (to be published 2015).
- <sup>25</sup> Ibid.
- <sup>26</sup> A portion of the 644 TBtu/year energy reduction opportunity results from the implementation of best practices and state-of-the-art commercial equipment.
- <sup>27</sup> “Bandwidth Study on Energy Use and Potential Energy Saving Opportunities in U.S. Chemical Manufacturing. Prepared by Energetics Inc. for the U.S. DOE Advanced Manufacturing Office (to be published 2015). Note: This study evaluated only the technical potential, not the economic potential, for energy reductions.
- <sup>28</sup> Metal Additive Manufacturing, “Additive Manufacturing Study Shows Cuts in Materials Consumption and Reduced CO2 Emissions.” December 4, 2013. Available at: <http://www.metal-am.com/articles/002733.html>.
- “The Printed World: Three-dimensional Printing from Digital Designs.” *The Economist*, February 10, 2011. Available at: [www.economist.com/node/18114221](http://www.economist.com/node/18114221).
  - Recyclability of powders for additive manufacturing affects materials consumption and is an active research area. See, for example, Wudy, K.; Drummer, D.; Kuhnlein, F.; Drexler, M. “Influence of Degradation Behavior of Polyamide 12 Powders in Laser Sintering Process on Produced Parts.” *AIP Conference Proceedings* (1593), 2014; p. 691.
- <sup>29</sup> National Institute of Standard and Technology. “Measurement Science Roadmap for Metal-Based Additive Manufacturing.” 2013. Available at: [http://www.nist.gov/el/isd/upload/NISTAdd\\_Mfg\\_Report\\_FINAL-2.pdf](http://www.nist.gov/el/isd/upload/NISTAdd_Mfg_Report_FINAL-2.pdf).
- Bullinger, H. *Technology Guide—Principles, Applications, Trends*. Springer, Berlin, 2009.
- <sup>30</sup> “The ASTM International Committee F42 on Additive Manufacturing Technologies.” Available at: <http://www.astm.org/COMMITTEE/F42.htm>.
- <sup>31</sup> Adapted from Huang, R.; Riddle, M.; Graziano, D.; Warren, J.; Das, S.; Nimbalkar, S.; Cresko, J.; Masanet, E. “Energy and Emissions Saving Potential for Additive Manufacturing: The Case of Lightweight Aircraft Components.” *Journal of Cleaner Production*, 2015 (in press).
- <sup>32</sup> Benatmane, J. “Environmental Report: Delphi Pump Housing.” Prepared by Econolyst for the Atkins Project. Available at: [http://www.enlighten-toolkit.com/App\\_Themes/Enlighten/Documents/PumpHousing-processes.pdf](http://www.enlighten-toolkit.com/App_Themes/Enlighten/Documents/PumpHousing-processes.pdf).
- <sup>33</sup> Ibid.
- <sup>34</sup> Energy bandwidth analyses include assessments of the energy consumption of current typical manufacturing processes, the energy consumption of state-of-the-art manufacturing processes, and the practical minimum energy consumption possible if research and development technologies currently under development were successfully deployed. Sector opportunities are analyzed by breaking down the sector into key subareas or subprocesses; for example, the 2015 “Bandwidth Study on Energy Use and Potential Energy Saving Opportunities in U.S. Chemical Manufacturing” investigated energy savings opportunities for 74 individual chemicals. A wide range of technical literature was used to assess current, state-of-the-art, and practical minimum energy levels and the resulting energy savings opportunities for each chemical; these individual opportunities were combined to estimate the total savings opportunity for the sector. The concept of an energy bandwidth and its use as an analysis tool for identifying energy saving opportunities originated in the U.S. DOE Advanced Manufacturing Office in 2002 (when it was called the Office of Industrial Technologies). The first two sector studies—“Iron and Steel” and “Metalcasting”—were completed in 2004. That work was followed by “Chemicals and Petroleum Refining” studies in 2006, and “Aluminum, Glass, and Mining” in 2007. A “Cement Industry” analysis was conducted in 2010 and a “Pulp and Paper” analysis was conducted in 2011. Four analyses (“Chemicals,” “Petroleum Refining,” “Iron and Steel,” and “Pulp and Paper”) are being updated in 2015. For more information about these studies and their methodology, please refer to the bandwidth studies available at: <http://www.energy.gov/eere/amo/energy-analysis-sector>.
- <sup>35</sup> Data source: “Bandwidth Study on Energy Use and Potential Energy Saving Opportunities in U.S. Chemical Manufacturing,” “Bandwidth Study on Energy Use and Potential Energy Saving Opportunities in U.S. Petroleum Refining,” “Bandwidth Study on Energy Use and Potential Energy Saving Opportunities in U.S. Pulp and Paper Manufacturing,” and “Bandwidth Study on Energy Use and Potential Energy Saving Opportunities in U.S. Iron and Steel Manufacturing,” prepared by Energetics Inc. for U.S. DOE Advanced Manufacturing Office, 2015 (to be published).



- <sup>36</sup> This overall CHP efficiency is based on the higher heating value (HHV) of the fuel and is the net electrical output plus the net useful thermal output (i.e., steam energy) produced by the system. See, for example, Table 1-3 in the U.S. Environmental Protection Agency “Combined Heat and Power Partnership, Catalog of CHP Technologies,” Section 1. Available at: [http://www.epa.gov/chp/documents/catalog\\_chptech\\_1.pdf](http://www.epa.gov/chp/documents/catalog_chptech_1.pdf)
- <sup>37</sup> U.S. Department of Energy (DOE) and U.S. Environmental Protection Agency (EPA). “Combined Heat and Power: A Clean Energy Solution.” DOE/EE-0779. August 2012. Available at: [http://www.epa.gov/chp/documents/clean\\_energy\\_solution.pdf](http://www.epa.gov/chp/documents/clean_energy_solution.pdf).
- <sup>38</sup> The White House Executive Order: “Accelerating Investment in Industrial Energy Efficiency.” August 30, 2012. Available at: <https://www.whitehouse.gov/the-press-office/2012/08/30/executive-order-accelerating-investment-industrial-energy-efficiency>.
- “Combined Heat and Power: A Clean Energy Solution,” U.S. DOE and U.S. EPA, August 2012. Available at: [http://energy.gov/sites/prod/files/2013/11/f4/chp\\_clean\\_energy\\_solution.pdf](http://energy.gov/sites/prod/files/2013/11/f4/chp_clean_energy_solution.pdf).
- <sup>39</sup> Note that capacity refers to electric output only. Capacity values quoted in this chapter and in the accompanying “Combined Heat and Power Systems” Technology Assessment are derived from the ICF International Combined Heat and Power database (funded by DOE through the Oak Ridge National Laboratory): Available at: <http://www.eea-inc.com/chpdata/>. As explained in the technology assessment, the data from this source is considered the best available estimates of the complete CHP market.
- <sup>40</sup> The power-to-heat ratio is defined as the proportion of power (electrical or mechanical energy) to heat energy (hot water or steam) produced by the CHP system. For detailed calculation methodology, see also Frangopoulos, C. A. “A Method to Determine the Power to Heat Ratio, the Cogenerated Electricity, and the Primary Energy Savings of Cogeneration Systems After the European Directive.” *Energy* (45), 2012; pp. 52-61.
- <sup>41</sup> U.S. Environmental Protection Agency Combined Heat and Power Partnership, “Catalog of CHP Technologies,” Section 1. Available at: [http://www.epa.gov/chp/documents/catalog\\_chptech\\_1.pdf](http://www.epa.gov/chp/documents/catalog_chptech_1.pdf).
- Industrial Efficiency Technology Database, “Combined Heat and Power (CHP) Generation.” Available at: <http://ietd.iipnetwork.org/content/combined-heat-and-power-chp-generation>.
- <sup>42</sup> Based on preliminary analysis by Oak Ridge National Laboratory. Analyses are performed on lower heating value (LHV) basis and converted to higher heating value (HHV) basis for reporting.
- <sup>43</sup> “Sankey Diagram of Process Energy Flow in U.S. Manufacturing Sector.” Available at: <http://energy.gov/eere/amo/sankey-diagram-process-energy-flow-us-manufacturing-sector>. The data source for the Sankey Diagram is the “Manufacturing Energy and Carbon Footprints (2010 MECS).”
- <sup>44</sup> Ibid.
- <sup>45</sup> “Number of Establishments by Usage of General Energy-Saving Technologies, 2010.” Energy Information Administration, 2013. Available at: [http://www.eia.gov/consumption/manufacturing/data/2010/pdf/Table8\\_2.pdf](http://www.eia.gov/consumption/manufacturing/data/2010/pdf/Table8_2.pdf).
- <sup>46</sup> Nimbalkar, S.; Thekdi, A. C.; Rogers, B. M.; Kafka, O. L.; Wenning, T. J.; “Technologies and Materials for Recovering Waste Heat in Harsh Environments.” Oak Ridge National Laboratory, 2015 (to be published).
- <sup>47</sup> “Report to the President: Accelerating U.S. Advanced Manufacturing, President’s Council of Advisors on Science and Technology AMP2.0 Steering Committee Report.” October 2014. Available at: [https://www.whitehouse.gov/sites/default/files/microsites/ostp/PCAST/amp20\\_report\\_final.pdf](https://www.whitehouse.gov/sites/default/files/microsites/ostp/PCAST/amp20_report_final.pdf).
- <sup>48</sup> Therkelsen, P.; et al. “Assessing the Costs and Benefits of the Superior Energy Performance Program.” July 2013. Available at: [http://eetd.lbl.gov/sites/all/files/aceee\\_sep\\_paper.pdf](http://eetd.lbl.gov/sites/all/files/aceee_sep_paper.pdf).
- <sup>49</sup> The SEP Measurement and Verification (M&V) Protocol defines the procedures used to confirm conformance with the energy performance requirements of the SEP Program. Available at: <http://energy.gov/eere/amo/downloads/superior-energy-performance-measurement-and-verification-protocol-industry>. In addition, more specific guidance on energy intensity baselining and tracking is available in “Energy Intensity Baselining and Tracking Guidance for the Better Buildings, Better Plants Program.” February 2015. Available at: <http://energy.gov/sites/prod/files/2015/02/f20/Energy%20Intensity%20Baselining%20and%20Tracking%20Guidance.pdf>.
- <sup>50</sup> Issues related to technology adoption are discussed in more detail in Chapter 10 of this report and in the “Supplemental Information” for this chapter.
- DOE case studies that detail the positive return on investment of SEP-certified facilities can be accessed at: <http://energy.gov/eere/amo/business-case-sep#case-studies>.
- <sup>51</sup> Eto, J. “The Past, Present, and Future of U.S. Utility Demand-Side Management Programs.” Lawrence Berkeley National Laboratory, 1996. Available at: <http://emp.lbl.gov/publications/past-present-and-future-us-utility-demand-side-management-programs>.
- <sup>52</sup> “Assessment of Demand Response and Advanced Metering.” Federal Energy Regulatory Commission, December 2014. Available at: <http://www.ferc.gov/legal/staff-reports/12-20-12-demand-response.pdf>.
- <sup>53</sup> “Manufacturing Energy and Carbon Footprints (2010 MECS).” U.S. DOE Office of Energy Efficiency & Renewable Energy. Available at: <http://energy.gov/eere/amo/manufacturing-energy-and-carbon-footprints-2010-mecs>.
- <sup>54</sup> Todd, D.; Caufield, M.; Helms, B.; Starke, M.; Kirby, B.; Kueck, J. “Providing Reliability Services Through Demand Response: A Preliminary Evaluation of the Demand Response Capabilities of Alcoa Inc.” Oak Ridge National Laboratory Report No. ORNL/TM-2008/233, January 2009. Available at: [https://eaei.lbl.gov/sites/all/files/Providing\\_Reliability\\_Services\\_through\\_Demand\\_Response\\_\\_A\\_Preliminary\\_Evaluation\\_of\\_the\\_Demand\\_Response\\_Capabilities\\_of\\_Alcoa\\_Inc..pdf](https://eaei.lbl.gov/sites/all/files/Providing_Reliability_Services_through_Demand_Response__A_Preliminary_Evaluation_of_the_Demand_Response_Capabilities_of_Alcoa_Inc..pdf).
- <sup>55</sup> Patterson, M. “Demand Response in the ERCOT Markets.” Presented at the DOE Load Participation in Ancillary Services Workshop, October 25-26, 2011, Washington, DC. Available at: [http://www1.eere.energy.gov/analysis/load\\_participation\\_workshop.html](http://www1.eere.energy.gov/analysis/load_participation_workshop.html).

- <sup>56</sup> “Energy Information Agency: Demand-Side Management Program Annual Effects by Program.” Available at: [http://www.eia.gov/electricity/annual/html/epa\\_10\\_02.html](http://www.eia.gov/electricity/annual/html/epa_10_02.html).
- <sup>57</sup> Starke, M.; Alkadi, N.; Ma, O. “Assessment of Industrial Load for Demand Response Across U.S. Regions of the Western Interconnect.” Oak Ridge National Laboratory Report No. ORNL/TM-2013/407, September 2013. Available at: <http://info.ornl.gov/sites/publications/files/Pub45942.pdf>.
- <sup>58</sup> Davito, B.; Tai, H.; Uhlener, R. *The Smart Grid and the Promise of Demand-side Management*. McKinsey & Company, 2010.
- “The Integrated Grid: Realizing the Full Value of Central and Distributed Energy Resources.” EPRI, 2014. Available at: <http://www.epri.com/abstracts/Pages/ProductAbstract.aspx?ProductId=00000003002002733>.
- <sup>59</sup> DOE/EERE. “Grid Integration Planning Workshop,” Arlington, VA, 2014.
- <sup>60</sup> David, S.W.; et al. “Fast Automated Demand Response to Enable the Integration of Renewable Resources.” CEC/LBNL, 2012. LBNL-5555E. Available at: <http://drcc.lbl.gov/sites/all/files/LBNL-5555E.pdf>.
- North American Electric Reliability Corporation. “Special Report: Potential Reliability Impacts of Emerging Flexible Resources.” November 2010. Available at: [http://www.nerc.com/files/IVGTF\\_Task\\_1\\_5\\_Final.pdf](http://www.nerc.com/files/IVGTF_Task_1_5_Final.pdf).
- <sup>61</sup> Cardoso, G.; et al. “Optimal Investment and Scheduling of Distributed Energy Resources with Uncertainty in Electric Vehicle Driving Schedules.” *Energy* (64:0), 2014; pp. 17-30.
- <sup>62</sup> *A Review of Distributed Energy Resources*. New York Independent System Operator, 2014.
- “The Integrated Grid: Realizing the Full Value of Central and Distributed Energy Resources.” EPRI, 2014. Available at: <http://www.epri.com/abstracts/Pages/ProductAbstract.aspx?ProductId=00000003002002733>.
- <sup>63</sup> Davito, B.; Tai, H.; Uhlener, R. *The Smart Grid and the Promise of Demand-side Management*. McKinsey & Company, 2010.
- <sup>64</sup> See the “Advanced Sensors, Control, Platforms, and Modeling for Manufacturing (Smart Manufacturing)” Technology Assessment.
- <sup>65</sup> For more discussion of the Smart Grid, see QTR Chapter 3, “Enabling Modernization of the Electric Power System.”
- <sup>66</sup> Mitra, S.; Sun, L. G.; Grossmann, I. E. “Optimal Scheduling of Industrial Combined Heat and Power Plants Under Time-sensitive Electricity Prices.” *Energy* (54), 2013; pp. 194-211.
- Mitra, S.; et al. “Optimal Production Planning Under Time-sensitive Electricity Prices for Continuous Power-Intensive Processes.” *Computers & Chemical Engineering* (38), 2012; pp. 171-184.
  - Ruth, M. F.; Zinaman, O. R.; Antkowiak, M.; Boardman, R. D.; Cherry, R. S.; Bazilian, M. D. “Nuclear-Renewable Hybrid Energy Systems: Opportunities, Interconnections, and Needs.” *Energy Conversion and Management* (Vol. 78), February 2014; pp. 684-694. NREL Report No. JA-6A50-58087, 2014.
- <sup>67</sup> Starke, M.; Alkadi, N.; Ma, O. “Assessment of Industrial Load for Demand Response Across U.S. Regions of the Western Interconnect.” Oak Ridge National Laboratory, 2013. Available at: <http://info.ornl.gov/sites/publications/files/Pub45942.pdf>.
- <sup>68</sup> Additive manufacturing is one example of a technology advancement that may expand the use of lightweight metals. See the “Additive Manufacturing” Technology Assessment for more details.
- See Chapter 8 for an extended discussion of lightweight materials for vehicles.
- <sup>69</sup> Suzuki T.; Takahashi, J. “Prediction of Energy Intensity of Carbon Fiber Reinforced Plastics for Mass-Produced Passenger Cars.” Ninth Japan International SAMPE Symposium, 2013. Available at: <http://j-t.o.o07.jp/publications/051129/S1-02.pdf>.
- <sup>70</sup> “Review of the Life Cycle Energy Consumption of Incandescent, Compact Fluorescent, and LED Lamps.” U.S. DOE, Buildings Technology Program, August 2012. Available at: [http://apps1.eere.energy.gov/buildings/publications/pdfs/ssl/2012\\_LED\\_Lifecycle\\_Report.pdf](http://apps1.eere.energy.gov/buildings/publications/pdfs/ssl/2012_LED_Lifecycle_Report.pdf).
- <sup>71</sup> One such sustainability decision-making tool, including a risk assessment/risk management framework, was developed by the National Research Council (NRC) for the U.S. Environmental Protection Agency (EPA): National Research Council. “Sustainability and the U.S. EPA.” 2011. Available at: <http://www.nap.edu/catalog/13152/sustainability-and-the-us-epa>.
- <sup>72</sup> “Critical Materials Strategy.” U.S. Department of Energy, 2010. Available at: <http://energy.gov/sites/prod/files/edg/news/documents/criticalmaterialsstrategy.pdf>.
- <sup>73</sup> “Critical Materials Strategy.” U.S. Department of Energy, 2010. Available at: <http://energy.gov/sites/prod/files/edg/news/documents/criticalmaterialsstrategy.pdf>.
- <sup>74</sup> “Revolution Now: The Future Arrives for Four Clean Energy Technologies—2014 Update.” U.S. Department of Energy, 2014. Available at: [http://cms.doe.gov/sites/prod/files/2014/10/f18/revolution\\_now\\_updated\\_charts\\_and\\_text\\_october\\_2014\\_1.pdf](http://cms.doe.gov/sites/prod/files/2014/10/f18/revolution_now_updated_charts_and_text_october_2014_1.pdf).
- <sup>75</sup> Md. Rabiul Islam; Youguang Guo; Jianguo Zhu, “A Review of Offshore Wind Turbine Nacelle: Technical Challenges, and Research and Developmental Trends.” *Renewable and Sustainable Energy Reviews* (33), 2014; pp. 161-176.
- <sup>76</sup> Alonso, E.; et al., “Evaluating Rare Earth Element Availability: A Case with Revolutionary Demand from Clean Technologies.” *Environmental Science & Technology*, 2012; pp. 3406-3414.
- <sup>77</sup> “Critical Materials Strategy.” U.S. Department of Energy, 2010. Available at: <http://energy.gov/sites/prod/files/edg/news/documents/criticalmaterialsstrategy.pdf>.

<sup>78</sup> See, for example:

- Duclos, S.J.; et al. "Design in an Era of Constrained Resources." *Mechanical Engineering* (132:9), 2010; pp. 36-40.
- General Electric. "Response to the U.S. Department of Energy Request for Information." May 24, 2011.
- Ku, A.; Hung, S. "Manage Raw Material Supply Risks." *American Institute of Chemical Engineers*, September 2014, p. 28.
- Graedel, T. E.; et al. "On the Materials Basis of Modern Society." PNAS, DOI 10.1073. Available at: <http://www.bgs.ac.uk/mineralsuk/statistics/risklist.html>.
- European Commission, "Critical Raw Materials for the EU." Available at: [http://ec.europa.eu/enterprise/policies/raw-materials/files/docs/crm-report-on-critical-rawmaterials\\_en.pdf](http://ec.europa.eu/enterprise/policies/raw-materials/files/docs/crm-report-on-critical-rawmaterials_en.pdf).
- Wuppertal Institut (2014), "Critical Resources and Material Flows during the Transformation of the German Energy Supply System," Available at: [http://wupperinst.org/uploads/tx\\_wupperinst/KRESSE\\_Endbericht\\_Summary.pdf](http://wupperinst.org/uploads/tx_wupperinst/KRESSE_Endbericht_Summary.pdf).

<sup>79</sup> Silbergliitt, R.; Bartis, J. T.; Chow, B. G.; An, D. L.; Brady, K. "Critical Materials: Present Danger to U.S. Manufacturing." 2013. Available at: [http://www.rand.org/content/dam/rand/pubs/research\\_reports/RR100/RR133/RAND\\_RR133.pdf](http://www.rand.org/content/dam/rand/pubs/research_reports/RR100/RR133/RAND_RR133.pdf).

- U.S. Geological Survey. "Mineral Commodity Summary: Bismuth." 2014. Available at: <http://minerals.usgs.gov/minerals/pubs/commodity/bismuth/mcs-2014-bismu.pdf>.
- The American Physical Society and the Materials Research Society. "Securing Materials for Emerging Technologies." 2011. Available at: <http://www.aps.org/policy/reports/popa-reports/upload/elementsreport.pdf>.

<sup>80</sup> See the "Materials for Harsh Service Conditions" Technology Assessment for a discussion of superalloys for high-efficiency gas and steam turbines.

<sup>81</sup> Numerous definitions for sustainable manufacturing are in use; all are concerned with the environmentally responsible production and use of manufactured goods. The U.S. Department of Commerce defines sustainable manufacturing as "the creation of manufactured products that use processes that are non-polluting, conserve energy and natural resources, and are economically sound and safe for employees, communities, and consumers." See [http://www.trade.gov/competitiveness/sustainablemanufacturing/how\\_doc\\_defines\\_SM.asp](http://www.trade.gov/competitiveness/sustainablemanufacturing/how_doc_defines_SM.asp). The U.S. Environmental Protection Agency defines sustainable manufacturing as "the creation of manufactured products through economically-sound processes that minimize negative environmental impacts while conserving energy and natural resources." See <http://www.epa.gov/sustainablemanufacturing/glossary.htm>. The Organisation for Economic Co-operation and Development defines it as "managing operations in an environmentally and socially responsible manner." See <http://www.oecd.org/innovation/green/toolkit/aboutsustainablemanufacturingandthetoolkit.htm>.

<sup>82</sup> "Material Flows in the United States—a Physical Accounting of the U.S. Industrial Economy." World Resources Institute, Washington, DC, 2008. Available at: [http://www.wri.org/sites/default/files/pdf/material\\_flows\\_in\\_the\\_united\\_states.pdf](http://www.wri.org/sites/default/files/pdf/material_flows_in_the_united_states.pdf).

<sup>83</sup> Gutowski, T.; Sahni, S.; Allwood, J.; Ashby, M.; Worrell, E. 2013. "The Energy Required to Produce Materials: Constraints on Energy-Intensity Improvements, Parameters of Demand." *Philosophical Transactions of the Royal Society A* (371): 20120003. Available at: <http://dx.doi.org/10.1098/rsta.2012.0003>.

<sup>84</sup> Gierlinger, S.; Krausmann, F. "The Physical Economy of the United States of America." *Journal of Industrial Ecology* 16(3), 2012; pp. 365-377.

<sup>85</sup> Huang, A.; Webb, C.; Matthews, H. S. "Categorization of Scope 3 Emissions for Streamlined Enterprise Carbon Footprinting." *Environmental Science and Technology* (43:22), 2009; pp. 8509-8515.

- See <http://www.ghgprotocol.org/calculation-tools/faq> for further details about scope 3 emissions sources.

<sup>86</sup> Based on analysis by the DOE Advanced Manufacturing Office, see the "Sustainable Manufacturing - Flow of Materials through Industry" Technology Assessment for additional details.

<sup>87</sup> Hiller, J.; Lipsom, H. "Fully Recyclable Multi-Material Printing." Solid Freeform Fabrication Symposium, August 3-5, 2009, Austin, TX, USA, 2009.

<sup>88</sup> National Renewable Energy Laboratory. "Best Research-Cell Efficiencies." Accessed April 30, 2015, at: [http://www.nrel.gov/ncpv/images/efficiency\\_chart.jpg](http://www.nrel.gov/ncpv/images/efficiency_chart.jpg).

<sup>89</sup> "Manufacturing Energy and Carbon Footprints (2010 MECS)." U.S. DOE Office of Energy Efficiency & Renewable Energy. Available at: <http://energy.gov/eere/amo/manufacturing-energy-and-carbon-footprints-2010-mecs>.

<sup>90</sup> Das, R. "The Rise of Thermoelectrics." 2013. Accessed February 17, 2014, from *Energy Harvesting Journal*: <http://www.energyharvestingjournal.com/articles/the-rise-of-thermoelectrics-00005925.as>.

<sup>91</sup> LeBlanc, S.; Yee, S. K.; Scullin, M. L.; Dames, C.; Goodson, K. E. "Material and Manufacturing Cost Considerations for Thermoelectrics." *Renewable and Sustainable Energy Reviews* (32), 2014; pp. 313-327.

<sup>92</sup> U.S. Energy Information Administration. (2014). "Electricity Data Browser." EIA.gov, 2014. Accessed September 24, 2014: <http://www.eia.gov/electricity/data/browser>.

<sup>93</sup> LeBlanc, S.; Yee, S. K.; Scullin, M. L.; Dames, C.; Goodson, K. E. "Material and Manufacturing Cost Considerations for Thermoelectrics." *Renewable and Sustainable Energy Reviews* (32), 2014; pp. 313-327.

<sup>94</sup> Tritt, T. M. "Thermoelectric Phenomena, Materials, and Applications." *Annual Review of Materials Research* (41), 2011; pp. 433-448.

<sup>95</sup> Typical efficiencies based on sales literature for thermoelectric modules. See, for example, Hi-Z Technology Inc. "HZ-14 Thermoelectric Module." hi-z.com 2014. Accessed April 30, 2015: <http://www.hi-z.com/uploads/2/3/0/9/23090410/hz-14.pdf>.

- <sup>96</sup> Tian, Z.; Lee, S.; Chen, G. “Heat Transfer in Thermoelectric Materials and Devices.” *Journal of Heat Transfer* (135:6), 2013; 061605. doi:10.1115/1.4023585.
- A maximum efficiency of 16.4% was reported for a skutterudite at a temperature difference of 500°C. See Liu, W.; Yan, X.; Chen, G.; Ren, Z. “Recent Advances in Thermoelectric Nanocomposites.” *Nano Energy* (1:1), 2012; pp. 42-56.
- <sup>97</sup> Fujisaka, T.; Sui, H.; Suzuki, R. O. “Design and Numerical Evaluation of Cascade-Type Thermoelectric Modules.” *Journal of Electronic Materials* (Vol. 42:7), 2013; pp. 1688-1696.
- <sup>98</sup> Yazawa, K.; Shakouri, A. “Energy Payback Optimization of Thermoelectric Power Generator Systems.” 2010. Proceedings of the ASME 2010 International Mechanical Engineering Congress & Exposition, Vancouver, BC, November 12-18, 2010. Available at: <https://quantum.soe.ucsc.edu/sites/default/files/IMECE2010-yazawa.pdf>.
- <sup>99</sup> Kaibe, H.; Makino, K.; Kajihara, T.; Fujimoto, S.; Hachiuma, H. “Thermoelectric Generating System Attached to a Carburizing Furnace at Komatsu Ltd., Awazu Plant.” In Ninth European Conference on Thermoelectrics: ECT2011 (Vol. 524), 2012; pp. 524–527. doi:10.1063/1.4731609.
- Kuroki, T.; Kabeya, K.; Makino, K.; Kajihara, T.; Kaibe, H.; Hachiuma, H.; Fujibayashi, A.; et al. “Thermoelectric Generation Using Waste Heat in Steel Works.” *Journal of Electronic Materials*, 2014. doi:10.1007/s11664-014-3094-5.
- <sup>100</sup> “Manufacturing Energy and Carbon Footprints (2010 MECS).” Available at: <http://energy.gov/eere/amo/manufacturing-energy-and-carbon-footprints-2010-mecs>.
- <sup>101</sup> Ibid.
- <sup>102</sup> Low estimate based on 10% recovery of process heating energy losses. See Polcyn, A.; Khaleel, M. “Advanced Thermoelectric Materials for Efficient Waste Heat Recovery in Process Industries.” 2009. High estimate based on 25% recovery. See Hill, J. M. “Study of Low-grade Waste Heat Recovery and Energy Transportation Systems in Industrial Applications.” 2011. The University of Alabama.
- <sup>103</sup> Based on a thermoelectric generation efficiency of 2.5%. For further details of calculations, see the “Direct Thermal Energy Conversion Materials, Devices, and Systems” Technology Assessment.
- <sup>104</sup> Conversion factor: 1 TBtu = 293 GWh.
- <sup>105</sup> Data from “Significant Incident 20 Year Trend.” U.S. DOT Pipeline and Hazardous Materials Safety Administration, 2014. Available at: [https://hip.phmsa.dot.gov/analyticsSOAP/saw.dll?Portalpages&NQUser=PDM\\_WEB\\_USER&NQPassword=Public\\_Web\\_User1&PortalPath=%2Fshared%2FPDM%20Public%20Website%2F\\_portal%2FSC%20Incident%20Trend&Page=Significant](https://hip.phmsa.dot.gov/analyticsSOAP/saw.dll?Portalpages&NQUser=PDM_WEB_USER&NQPassword=Public_Web_User1&PortalPath=%2Fshared%2FPDM%20Public%20Website%2F_portal%2FSC%20Incident%20Trend&Page=Significant).
- <sup>106</sup> Hofmann, P.; Hagen, S.; Schanz, G.; Skokan, A. “Chemical Interaction of Reactor Core Materials Up to Very High Temperatures.” Kernforschungszentrum Karlsruhe Report No. 4485 (1989).
- <sup>107</sup> Opportunity based on a 10% increase in efficiency for new power plants added by 2040, measured from a baseline efficiency of 60% (the current state of the art). For further details of calculations, see the “Materials for Harsh Service Conditions” Technology Assessment.
- <sup>108</sup> Opportunity based on recovery of heat from currently unrecoverable waste heat sources in the steel, glass, aluminum, and cement/lime industries. For further details of calculations, see the “Materials for Harsh Service Conditions” Technology Assessment.
- <sup>109</sup> Opportunity based on elimination of methane gas leaks and energy content lost to gas leaks. For further details of calculations, see the “Materials for Harsh Service Conditions” Technology Assessment.
- <sup>110</sup> Nuclear opportunity is based on emissions from displaced fossil fuel generation, assuming nuclear reactor refueling shutdowns at 36 months instead of 18 months. For further details of calculations, see the “Materials for Harsh Service Conditions” Technology Assessment.
- <sup>111</sup> Energy opportunity not applicable because increased nuclear generation would displace other electricity generation.
- <sup>112</sup> “NSTC 2011—Materials Genome Initiative for Global Competitiveness.” National Science and Technology Council (NSTC), June 2011.
- <sup>113</sup> Materials Genome Initiative. Available at: <https://www.whitehouse.gov/mgi>.
- <sup>114</sup> “Implementing ICME in the Aerospace, Automotive, and Maritime Industries.” The Metals, Minerals, and Materials Society (TMS), 2013. Available at: <http://www.tms.org/icmestudy/Default.aspx>.
- Li, C.; Henry, C.S.; Jankowski, M.D.; Ionita, J.A.; Hatzimanikatis, V.; Broadbelt, L.J. “Computational Discovery of Biochemical Routes to Specialty Chemicals.” *Chem. Eng. Sci.*, 59(22-23), 2004; pp. 5051-5060.
- <sup>115</sup> References:
- Navigant Consulting Inc., D&R International Ltd., & Lawrence Berkeley National Laboratory. “Technical Support Document: Energy Efficiency Program for Consumer Products and Commercial and Industrial Equipment: Battery Chargers and External Power Supplies.” 2012.
  - Eykyn, J. (2013). *The World Market for AC-DC & DC-DC Merchant Power Supplies - 2013 Edition* (Vol. 9790). IHS. Wellingborough.
  - Gartner. (2014). Gartner Says Worldwide Traditional PC, Tablet, Ultramobile and Mobile Phone Shipments to Grow 4.2 Percent in 2014 press release. Accessed October 15, 2014: <http://www.gartner.com/newsroom/id/2791017>.
  - Boyd, S. B.; Horvath, A.; Dornfeld, D. “Life-Cycle Energy Demand and Global Warming Potential of Computational Logic.” *Environmental Science & Technology* (43:19), 2009; pp. 7303–7309. doi:10.1021/es901514n. Note: Total does not add up correctly owing to independent rounding.

- <sup>116</sup> Agarwal, A. "Manufacturing Perspective on Wide Bandgap Devices: Can WBG Prices Compete with Today's Si Prices." MRS 2014 presentation, Boston, MA, Dec. 3, 2014.
- <sup>117</sup> PowerAmerica. Available at: <http://energy.gov/eere/amo/power-america>.
- <sup>118</sup> The Minerals, Metals and Materials Society "Materials: Foundation for the Clean Energy Age." 2012. Accessed: [http://energy.tms.org/docs/pdfs/Materials\\_Foundation\\_for\\_Clean\\_Energy\\_Age\\_Press\\_Final.pdf](http://energy.tms.org/docs/pdfs/Materials_Foundation_for_Clean_Energy_Age_Press_Final.pdf).
- <sup>119</sup> The Minerals, Metals and Materials Society (2011). "Linking Transformational Materials and Processing for an Energy Efficient and Low-Carbon Economy: Creating the Vision and Accelerating Realization, Innovation Impact Report." 2011. Accessed: [http://energy.tms.org/docs/pdfs/Phase\\_III\\_Report.pdf](http://energy.tms.org/docs/pdfs/Phase_III_Report.pdf).
- <sup>120</sup> U.S. Department of Energy. "2011 Quadrennial Technology Review." 2011, p. 39. Available at: <http://energy.gov/downloads/first-quadrennial-technology-review-qtr-2011>.
- <sup>121</sup> Warren, C. D. "High Volume Vehicle Materials." US Low Carbon Vehicles Workshop. Georgia Technological University, Atlanta, Georgia, 2012.
- <sup>122</sup> <http://energy.tms.org/docs/pdfs/InnovationImpactReport2011.pdf>.
- <sup>123</sup> "Composites World." Accessed October 3, 2013: <http://www.compositesworld.com/news/plasan-sheds-light-on-its-automotive-composites-work-in-michigan>.
- <sup>124</sup> Dow Automotive Systems. YouTube Video Published October 1, 2013: Live demonstration of Dow Automotive Systems VORAFORCE 5300 epoxy formulation for high-speed mass production of light-weight structural carbon-fiber automotive composites, via high-pressure resin transfer molding (RTM) process. Available at: <http://www.youtube.com/watch?v=lgjtkpySvhY>.
- <sup>125</sup> Energy intensities and savings opportunities were calculated based on a review of technical literature describing commercial production technologies and R&D technologies under development. Source: "Preliminary Findings of the Lightweight Materials Bandwidth Study." Prepared by Energetics Incorporated for the National Renewable Energy Laboratory and the U.S. DOE Advanced Manufacturing Office (to be published, 2015).
- <sup>126</sup> U.S. Department of Energy. "Hydrogen and Fuel Cells Program Plan." 2011, p.3. Accessed: [http://www1.eere.energy.gov/hydrogenandfuelcells/pdfs/program\\_plan2011.pdf](http://www1.eere.energy.gov/hydrogenandfuelcells/pdfs/program_plan2011.pdf).
- <sup>127</sup> Stetson, N. "Hydrogen Storage Session Introduction." 2013 Annual Merit Review Proceedings—Hydrogen Storage. Available at: [http://www.hydrogen.energy.gov/pdfs/review13/st000\\_stetson\\_2013\\_o.pdf](http://www.hydrogen.energy.gov/pdfs/review13/st000_stetson_2013_o.pdf).



## Issues and RDD&D Opportunities

- Fossil fuels account for 82% of total U.S. primary energy use.
- Each fuel has strengths and weaknesses in relation to energy security, economic competitiveness, and environmental responsibility identified in Chapter 1.
- Low-cost fuels can contribute to economic prosperity. Oil and gas can be low cost but can also have volatile prices; bioenergy technology costs have declined significantly, but further improvements are needed; and hydrogen costs vary significantly with the source energy used to create the hydrogen, with further reductions needed.
- Energy security requires stable, abundant domestic resources. Oil and gas have large resource bases for domestic production. Bioenergy has intermediate levels of potential supplies. Fossil energy and bioenergy sources have land use constraints and controversies unique to each. Hydrogen can be produced from any energy resource—fossil, nuclear, renewable—so it can be domestically produced.
- Meeting environmental goals requires reduction of greenhouse gas emissions and other externalities. Oil and gas have a poor carbon footprint and other environmental issues that require attention to carbon capture, utilization (where possible), and storage (CCS), as described in Chapter 4. Bioenergy can have a good carbon footprint, and when combined with CCS, can provide a net reduction of atmospheric carbon dioxide levels. Hydrogen can be carbon neutral or not, depending on the source of the energy to produce it and whether CCS is used.
- The economy will rely on a broad mix of fuels, balanced across their various strengths and shortcomings, during the transition from a high-carbon to a low-carbon economy.
- Research, development, demonstration, and deployment (RDD&D) can help address the shortcomings of these fuels while increasing economic competitiveness and energy independence.

# 7

## Advancing Systems and Technologies to Produce Cleaner Fuels

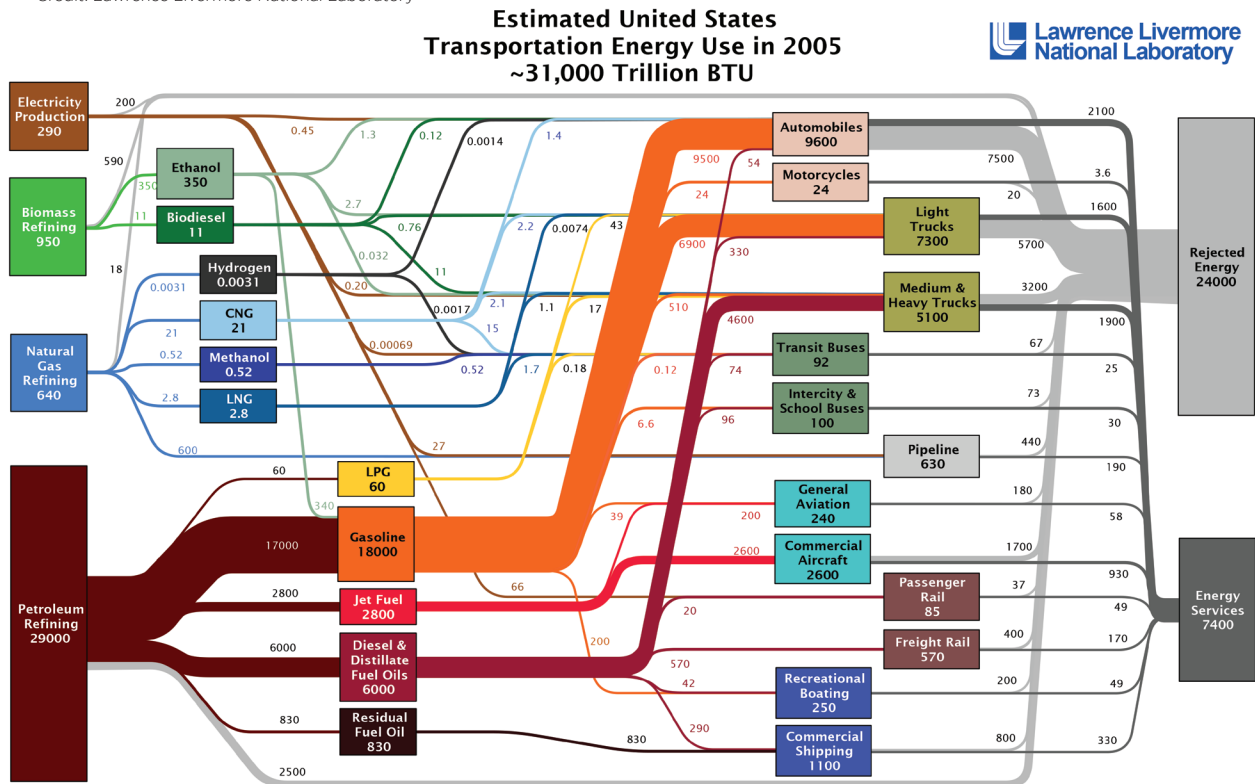
### 7.1 Introduction

Fuels play a critical role throughout our economy. In 2013, fuels directly supplied about 99% of the energy needed by our national transportation system, 66% of that needed to generate our electricity, 68% of that needed by our industry, and 27% of that needed by our buildings.<sup>1</sup>

For the purposes of this Quadrennial Technology Review (QTR), a “fuel” is defined as a carrier of chemical energy that can be released via reaction to produce work, heat, or other energy services. Fuel resources include oil, coal, natural gas, and biomass. The diversity of liquid and gaseous fuel use in the transportation sector is depicted in Figure 7.1. The source and mix of fuels used across these sectors is changing, particularly the rapid increase in natural gas production from unconventional resources for electricity generation and the rapid increase in domestic production of shale oil. Nuclear fuel and other energy resources, such as geothermal, hydropower, solar, and wind energy, are treated separately in Chapter 4.

**Figure 7.1** Sankey Diagram of Transportation Fuel Use

Credit: Lawrence Livermore National Laboratory



Source: LLNL 2011. Data is based on DOE/ORNL-6985(2010), July 2010. If this information or a reproduction of it is used, credit must be given to the Lawrence Livermore National Laboratory and the Department of Energy, under whose auspices the work was performed. All quantities are rounded to 2 significant digits and annual flows of less than 0.0005 trillion BTU are not included. Totals may not equal sum of components due to independent rounding. LLNL-TR-513773

Fossil fuels account for 82% of total U.S. primary energy use because they are abundant, have a relatively low cost of production, and have a high energy density—enabling easy transport and storage. The infrastructure built over decades to supply fossil fuels is the world's largest enterprise with the largest market capitalization.

While fuels are essential for the United States and the global economy, they also pose challenges:

- **Security:** Fuels should be available to the nation in a reliable, continuous way that supports national security and economic needs. Disruption of international fuel supply lines is a serious geopolitical risk.
- **Economy:** Fuels and the services they provide should be delivered to users and the markets at competitive prices that encourage economic growth. High fuel prices and/or price volatility can impede this progress.
- **Environment:** Fuels should be supplied and used in ways that have minimal environmental impacts on local, national, and global ecosystems and that enable their sustainability. Waste streams from fossil fuel production, such as produced water, and from fossil fuel use, such as carbon dioxide (CO<sub>2</sub>) emissions, are causing serious problems in many locations across the globe. Biofuels can raise potential land-use conflicts.

Each fuel type has advantages and disadvantages with respect to our nation's security, economy, and environment. Since these needs are vital to the national interest, it is essential to improve fuels in all three dimensions and maintain a robust set of options for rapidly changing conditions.

In the long term, to reduce U.S. greenhouse gas (GHG) emissions, significant deployment of carbon capture, utilization, and storage (CCS), coal/biomass to liquids (CBTL) and/or bioenergy with carbon capture and storage (BECCS) will be needed to enable fossil fuels to continue to be robust contributors to our nation's energy needs (CCS technology and economics is addressed in Chapter 4). Renewable fuels show promise, but biofuels face land constraints, and hydrogen production from renewables is currently expensive; significant research, development, demonstration, and deployment (RDD&D) remains to solve the challenges associated with scale and cost for these fuels.

In the near to mid term, multiple technological pathways need to be explored to serve as bridges to a low-carbon future. Particular focus should be given to interim technologies that help alleviate GHG challenges while minimizing embedded infrastructure changes that would inhibit the transition to sustainable solutions. Fuel sources such as natural gas and first generation biofuels, if utilized properly, could help enable this transition.

Each type of fuel has an associated system to produce the resource, upgrade, and transport it to a facility for cleanup and/or conversion into its final form for distribution to the end user. Although many of these steps are unique for each particular fuel, some do interconnect, particularly as they enter distribution systems. Here, three major fuel systems and a few alternatives will be discussed. Because the primary focus of this QTR is on RDD&D opportunities, processes for mature fuel systems for which there is no longer a federal role are not considered further here.

This chapter focuses on oil and gas and biomass production and conversion, hydrogen production, and a few alternatives such as CBTL with CCS, with a particular emphasis on fuels for transportation (e.g., automobiles, trucks, off-road vehicles, aircraft, ships). The transportation sector represents one-third of global energy use, one-third of global emissions, and nearly 90% of oil use. Because the fuels are carried on board, the challenges for weight, energy density, and storage are particularly difficult for fuels to meet. Transportation fuels—oil—also represent significant challenges with regard to domestic energy security, balance of trade, and environmental controls.

The United States currently consumes about 290 billion gallons per year of fuels, petrochemical products, and other commodities manufactured primarily from crude oil. Most of these fuels and products are used for transportation or for heavy equipment in the industrial sector. Table 7.1 shows the current composition of this market and anticipated future changes, as projected by the U.S. Energy Information Administration (EIA).



The United States has large reserves of oil, gas, and coal, with reserves of each among the top ten largest in the world. Recent technology developments have led to improved abilities to extract these fossil resources, particularly from unconventional sources, significantly impacting fuel prices in the United States. Increased domestic oil and gas production has brought the United States into production parity with Saudi Arabia, which has important security implications. However, generally increasing global demand is expected to exert upward pressure on market prices over time.

While fossil fuels have advantages from an economic and security perspective, their emissions of greenhouse gases, chiefly CO<sub>2</sub>, and methane (CH<sub>4</sub>), are the primary contributor to global warming. Potential impacts on water systems are also a growing concern. This has led to increased investment, development, and commercialization of fuels that would reduce climate, water, and/or other impacts.

**Table 7.1** Market Size of U.S. Liquid Fuels and Products (billion gallons/year)

	2013	2040 projected	Growth 2012–2040 (percent per year) <sup>a</sup>
Gasoline	136	108	-0.8%
Diesel	55	64	0.6%
LPG <sup>b</sup>	38	50	1.0%
Other <sup>c</sup>	31	37	0.7%
Jet fuel	22	29	1.0%
Residual fuel oil	5	4	-0.4%
<b>Total</b>	<b>291</b>	<b>295</b>	<b>0.1%</b>

Source: U.S. Energy Information Administration, 2015<sup>2</sup>

<sup>a</sup> Growth rate is a compound annual growth rate assuming geometric growth.

<sup>b</sup> Includes ethane, natural gasoline, and refinery olefins.

<sup>c</sup> Includes kerosene, petrochemical feedstocks, lubricants, waxes, asphalt, and other commodities.

Some fuels, such as hydrogen and alcohols, can be derived from both renewable and fossil resources. Hydrocarbon fuels that are compatible with the existing fossil fuel infrastructure can also be synthesized from renewable resources. These fuels have great potential as environmentally sound, sustainable, and domestic resources. To achieve economic parity with fossil fuels, more research is needed and potential environmental consequences will need to be addressed.

This chapter considers three primary fuel pathways—oil and natural gas, biomass, and hydrogen—their associated economic, security, and environmental concerns, and technology and industrial ecosystems. For each, current technology is reviewed and key RDD&D opportunities are identified that could help resolve their challenges. In the oil and gas sector, further research related to resource extraction could lower costs for producers as well as reduce some environmental impacts (Chapter 4). Biofuels can benefit from RDD&D across the entire value chain, from resources through conversion to a variety of refined products. Hydrogen can be produced via a variety of industrially proven technologies from fossil sources such as natural gas, but further RDD&D for producing hydrogen from renewables could lower costs and risks. Hydrogen’s other challenges include storage, transmission, and distribution infrastructure, fuel cell cost and durability, as well as economic

scale-up across the entire value chain. The chapter concludes with a brief survey of additional fuel pathways (CBTL, dimethyl ether, ammonia, etc.), each of which has intrinsic technological merit, but all of which also face challenges.

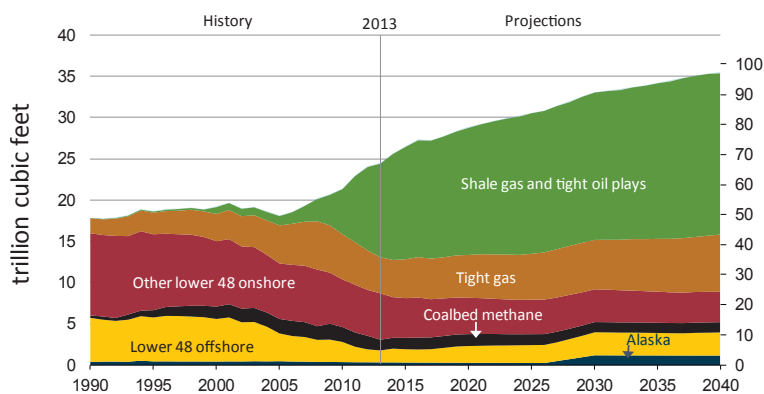
In addition to security concerns for imported oil and economic concerns over fuel prices and price volatility, environmental concerns are important for the entire global fuel enterprise. For fossil fuels used in buildings and some industries, CCS systems near the point of use may often not be possible. This provides motivation for converting fossil resources to low-carbon energy carriers, such as electricity or hydrogen, at a central location where CCS can be deployed, and then using these energy carriers at the distributed locations. Concurrently, development of carbon-neutral fuels utilizing biomass or renewable energy sources is needed. This chapter examines RDD&D opportunities associated with these transitions and their attendant challenges.

## 7.2 Oil and Gas

Until recently, U.S. oil production was in decline. Oil imports contributed more than half of domestic oil

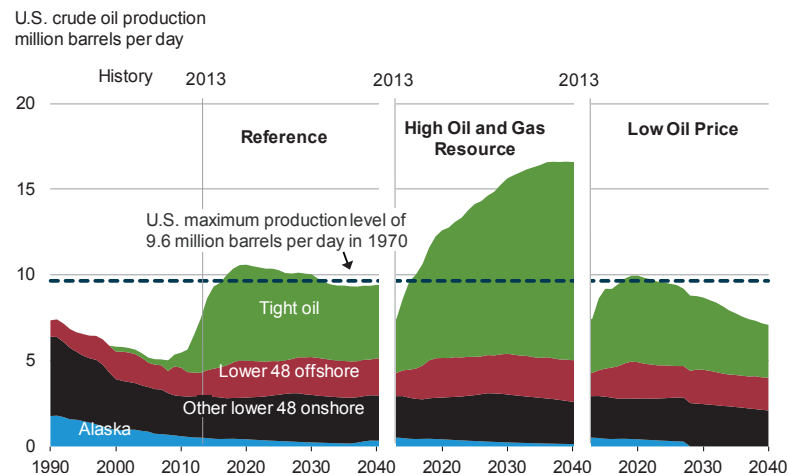
**Figure 7.2** Shale Resources Remain the Dominant Source of U.S. Natural Gas Production Growth<sup>6</sup>

Credit: U.S. Energy Information Administration



**Figure 7.3** Expected Gains in Tight Oil Production Drive Projected Growth in Total U.S. Crude Oil Production<sup>6</sup>

Credit: U.S. Energy Information Administration



consumption. Natural gas investment was moving toward expensive terminals to import natural gas. Today, the United States is the world's largest producer of oil and natural gas. It is exporting more refined products, and is on the path toward exporting liquefied natural gas (LNG).<sup>3</sup> Figure 7.2 demonstrates historic shale gas production and future production potential.

These considerable changes result primarily from technology developments in hydraulic fracturing and horizontal drilling that have allowed industry to produce oil and gas from low-permeability formations including shale and “tight” formations, often called “unconventional resources.” These advances were generated in part by DOE’s technological investments in the early 1980s, and in part by industry’s continued development and application of those technologies.<sup>4,5</sup> Together with increased work in rock mechanics and the understanding of fracture development and propagation

to enhance production, these technological advances have driven the rapid increase in production from unconventional resources. Figure 7.3 shows the projected growth from tight oil production.

Concurrent with these technological advances has been the drive to reduce the environmental impacts of oil and gas production, especially following public concerns about hydraulic fracturing onshore and the BP Deepwater Horizon incident offshore (Figure 7.4). Government mandates to increase safety and environmental stewardship have advanced safety regulations and practices, promoted development of safety cultures, and developed accident mitigation technologies. Industry has also responded with practices that reduce environmental and safety impacts and risks. However, ongoing environmental and safety challenges underscore the opportunity for continued RDD&D, particularly in those areas where there may be significant public benefit but industry may see no return—immediate or otherwise—on that investment.

## 7.2.1 Recent Technology Advancements

In 2011, the National Petroleum Council reported that the resource base for technically recoverable oil and gas was 2.3 quadrillion cubic feet of natural gas,<sup>8</sup> and 167 billion barrels of oil.<sup>9</sup> Advanced technology can help make these resources economically recoverable in an environmentally prudent way.

Progress in technology development over the last five to ten years, both offshore and onshore, has been focused in several distinct areas:

- Sophisticated data acquisition, processing, and visualization applied across the sector, from exploration to field maintenance and safe final plugging of wells
- Water conservation and protection, chiefly through treatments enabling water reuse, as well as use of brines and non-potable water in oil and gas applications
- Materials science, especially in cements and metals used for wellbore isolation and integrity
- Technologies to increase reservoir recovery factors; in particular, via stimulation

**Figure 7.4** BP Deepwater Horizon Oil Spill April 20, 2010<sup>7</sup>

Credit: U.S. Coast Guard



On April 20, 2010, the Macondo well—located about fifty miles from New Orleans in more than 5,000 feet of water, with a pay depth of greater than 18,000 feet subsea—blew out, costing the lives of eleven men and spilling more than four million barrels of crude oil into the Gulf of Mexico. A presidential commission identified the root causes to be associated with zonal isolation during cementing and the failure to create a competent barrier to uncontrolled flow. Other risk factors contributing to this disaster were associated with well monitoring equipment on the Deepwater Horizon, including data displays, and the lack of attentiveness to the risk resulting from deviation from the original designs for well construction.

- Combining increased oil and gas recovery with carbon sequestration in a technique known as CO<sub>2</sub> enhanced oil recovery (CO<sub>2</sub>-EOR)
- Oil spill prevention technology for operations in deep and ultra-deep waters
- Research and development (R&D) for operations in extreme environments, especially the Arctic, which contains significant oil and gas resources in environmentally sensitive areas

However, the most profound technical developments have been in the field of drilling and completions, including horizontal drilling and hydraulic fracturing.

### Onshore Well Construction: Drilling, Completion, and Stimulation

Technologies are being developed that will result in the need for fewer wells overall with far lesser impact on the surface and subsurface environments. Advances include reducing the drilling footprint through the use of drilling pads that allow multiple wells to be drilled from a single pad location.<sup>10</sup> Pad drilling can also enable rigs to be moved using railed systems. More recent technology has led to “walking rigs” that can travel from pad to pad under their own power.<sup>11</sup> New technologies provide more precise information about the subsurface location of oil and gas zones. Of key significance are technologies that allow operators to steer wells more precisely and with greater control.<sup>12</sup> Advances in the chemical formulations of drilling fluids have reduced their toxicity.<sup>13</sup>

There have also been technological advances in well completion and stimulation. Hydraulic fracturing of a single well at various points along the horizontal length in shale formations can dramatically increase initial production from new wells.<sup>14</sup> Advances in fracturing fluid technology plus technologies to treat flowback and produced water may enable production companies to recycle and/or reuse the same water for hydraulic fracturing and other operations depending on technology, transportation, and economic factors.<sup>15</sup>

Examples below of RDD&D for onshore and offshore completion technologies demonstrate how the above technology development areas have played a role in advancing hydrocarbon recovery and reducing environmental impact at the surface and in the subsurface.

### Offshore Well Construction and Operations

Drilling challenges in deep and ultra-deep water are different from those onshore because of the lower strength of these geologic formations, which can increase the risk of loss of well control. Technologies such as dual gradient and managed pressure drilling reduce this challenge, allowing for more controlled—and safer—drilling.

Much technology development has focused on oil spill prevention and mitigation. The Macondo/BP Deepwater Horizon incident focused attention on over-pressured zones and the integrity of the entire well construction system during the drilling process, particularly on the components of the system, such as casing, cement, and the seal that must be established between the rock and the well.<sup>16</sup> Progress has been made in expandable casing,<sup>17</sup> a technology that helps ensure integrity of the wellbore while allowing the well to maintain a larger diameter for a longer interval. This has been accompanied by advances in metallurgy and cement chemistry, resulting in downhole tubulars with lower fatigue and failure rates in the case of metallurgy,<sup>18</sup> and wellbores with enhanced integrity due to advances in cementing technology.<sup>19</sup>

Substantial research has been conducted, and is ongoing, for foamed cement<sup>20</sup> in applications where low density fluids and sealing materials are required, and for alternatives to traditional cement. Integrity monitoring of downhole tubulars and cement, in real time through the placement of downhole temperature and pressure sensors, has been introduced in an attempt to identify and mitigate potential failure.

As in the onshore sector, advances in logging-while-drilling and measurement-while-drilling,<sup>21</sup> including measurements at the drill bit, allow for greater precision in steering deviated and lateral wells, while identifying the potential for unexpected pressure anomalies.

Technological advances with regard to metallurgical options and analysis of fatigue and failure in metal components, especially with application to drilling risers (which connect the well to the drillship), are ongoing.<sup>22</sup> Existing metal properties are being examined<sup>23</sup> and new alloys are being studied and developed. Advances in remote inspection capabilities using remotely operated vehicles and autonomous underwater vehicles are being made.<sup>24</sup>

Blowout preventer design has been reexamined and new technology developed for control systems and sealing and cutting rams. In order to promptly contain the spill at or near the wellhead after a blowout or other loss of well control, industry has invested significant resources in subsea spill containment capabilities.<sup>25</sup>

Considerable progress has been made in subsea processing technologies, allowing processing of produced fluids at the seafloor to be sent from the field to gathering pipeline systems via subsea pumping systems. The corrosion caused by saltwater is another challenge unique to offshore production. Inspection of Gulf of Mexico facilities, especially older ones, is important for continuation of safe operations offshore. New technologies and analytical algorithms have been developed to allow subsea inspection of offshore facilities to identify failed or at-risk structural components.<sup>26</sup>

### Enhanced Oil Recovery (including CO<sub>2</sub>-EOR and ROZ)

Improved oil recovery (IOR) and EOR are technical strategies used to increase the amount of oil and/or gas recovered from a particular deposit. In the past, these terms have had more precise definitions, but now the terms are used more generally to indicate any technical activity that can increase the ultimate recovery from oil and gas reservoirs. These technologies generally include the injection of water, steam, gas, chemicals, or microbes, or other techniques to address some particular barrier in the reservoir that is preventing greater recovery of hydrocarbons. Each has its strengths and all have increased costs that affect project economics.

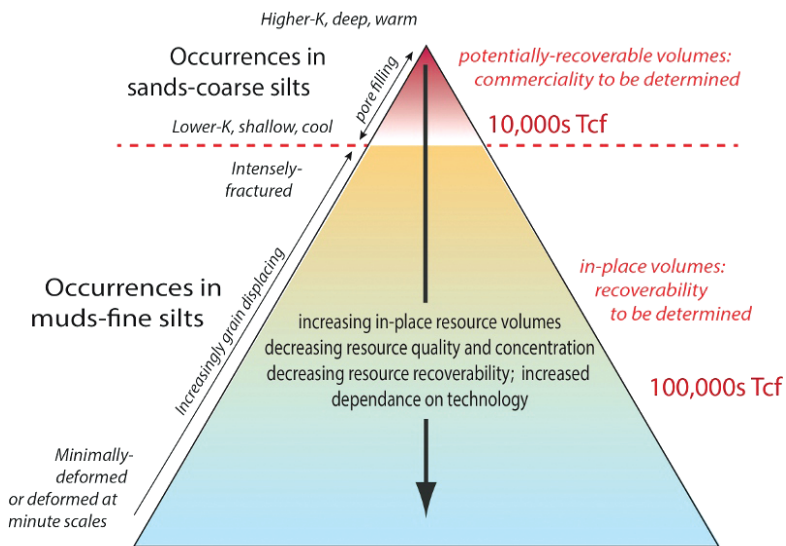
The potential application for CO<sub>2</sub>-EOR has gained interest because of the potential for sequestering CO<sub>2</sub> while improving recovery of hydrocarbons. In two common approaches, CO<sub>2</sub>, either naturally occurring or captured from industrial or power generation processes (anthropogenic CO<sub>2</sub>), is injected into oil bearing formations, either alternating with water (water-alternating-gas) or as a continuous flood in the reservoir. CO<sub>2</sub>-EOR has a lower carbon footprint compared to other EOR/IOR technologies, such as the use of steam. Currently, CO<sub>2</sub>-EOR accounts for about 300,000 barrels or almost 4% of U.S. daily production of crude oil.<sup>27</sup>

CO<sub>2</sub>-EOR is now being used to exploit recently identified residual oil zones (ROZ). ROZs exist in many mature fields and in migration fairways between fields. Within fields, residual oil can be found below the oil/water contact, or in areas that were bypassed in the normal production processes. CO<sub>2</sub>-EOR for producing oil in ROZs began in the 1990s. The oil in the ROZ is immobile (i.e., at irreducible saturation) and cannot be produced by primary or secondary recovery means. However, it does appear to respond well to CO<sub>2</sub>-EOR, and eight fields within the United States produce oil using this technique. It appears possible in some formations to produce oil with a near-zero carbon footprint.<sup>28</sup> More research would help industry understand the size and extent of ROZs, and how to minimize their carbon footprint. ROZ resources located predominantly in the Permian Basin have more than 250 billion barrels of oil in place.

## Natural Gas Hydrates

Traditional assessments of gas hydrate resources produce a wide range of very large estimates. Scientific drilling, experimental studies, and numerical simulation consistently indicate that high-concentration deposits in sand-rich sediments are amenable to traditional oil and gas exploration and production approaches.<sup>29</sup> The latest, but very poorly constrained, assessment of this portion of the gas hydrate resource pyramid (Figure 7.5)

**Figure 7.5** Gas Hydrate Resource Pyramid<sup>30</sup>



is on the order of ~100 trillion cubic feet (Tcf) in Alaska,<sup>31</sup> and perhaps 1,000s to 10,000 Tcf in the United States offshore. One global assessment reports an estimate of 40,000 Tcf in resource grade deposits worldwide,<sup>32</sup> the equivalent of more than 300 years of global gas consumption today.

Gas hydrate research continues to escalate internationally, with programs currently underway in the United States, Japan, Korea, India, and China. These efforts continue to improve the technologies for gas hydrate characterization via remote sensing and field sampling and analysis, and mature the

scientific understanding on the nature, occurrence, and dynamic development of gas hydrate systems. The most aggressive program is underway in Japan, where extensive past drilling has suggested ~200 Tcf of resource potential and enabled advanced characterization of prospective reservoirs off the nation's southeastern coast.

A series of scientific field production experiments conducted in the Arctic by Japan, the United States, and Canada has led to the identification of depressurization as the most promising base technology for gas production from gas hydrates. In 2013, Japan tested this approach for the first time in a deepwater setting with promising results, and has announced their plan for R&D. Detailed geologic descriptions of actual gas hydrate reservoirs have only recently been matched with advanced numerical simulation capabilities that honor the complex thermodynamics of gas hydrate dissociation.

Safety and environmental risks from gas hydrate production are comparable to those in all oil and gas production. Well control risks are more limited because of the shallow, low-pressure setting of gas hydrate reservoirs. Reservoir subsidence and resultant instability in overburden and at the seafloor is a risk that may be most relevant to gas hydrate production, particularly in marine applications, given the shallow and generally unconsolidated nature of most potential gas hydrate reservoirs.

### 7.2.2 Emerging Research Opportunities

Large strides in technology, safety, and environmental practices have been made, yet a set of persistent and emerging challenges remain, which points to a set of research opportunities (Table 7.2). Some opportunities are important to address in the near term, in part because of the driving needs of policymakers, regulators, and

**Table 7.2** Emerging Issues Around Hydrocarbon Production. Near term, medium term, and long term refer to potential outcomes with substantial impacts within the time frame.

Key research opportunities	Near term (2–5 years)	Medium term (5–10 years)	Long term (>10 years)
Environmentally sustainable drilling and completion technologies and methodologies <sup>33</sup>	✓		
Unconventional oil and gas environmental challenges	✓	✓	
Offshore and Arctic oil spill prevention	✓	✓	
Gas hydrates characterization			✓

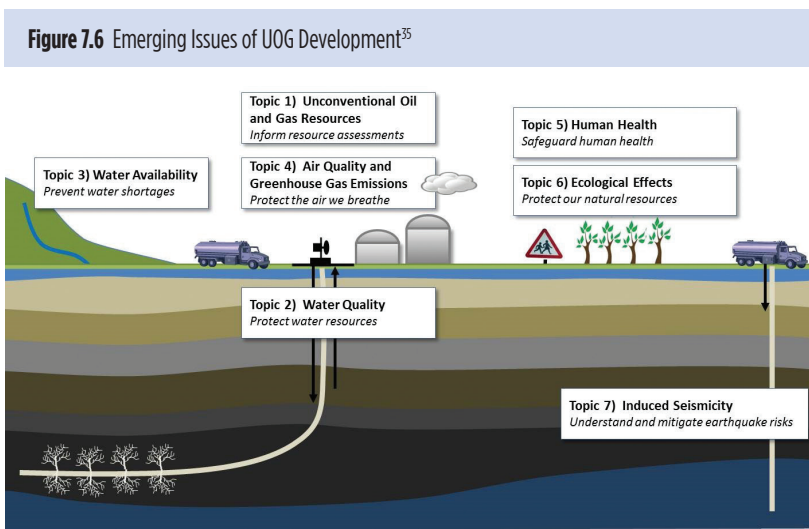
other public stakeholders. Other opportunities are less so, but may either dramatically improve environmental performance or dramatically increase resource availability.

In recognition of these emerging challenges, many groups in industry, government, and academia have highlighted potential RDD&D efforts, including the National Academy of Sciences; federal advisory groups such as the National Petroleum Council (NPC) and the Secretary of Energy Advisory Board; environmental organizations such as the Environmental Defense Fund, Natural Resources Defense Council, and World Resources Institute; and state governments. The oil and gas industry is engaged in significant but often proprietary RDD&D efforts. These challenges can be grouped and divided into the four themes discussed below.

### Environmentally Sound Drilling and Completions

#### “Golden Rules” or Best Practices

The International Energy Agency recently published a set of principles or “Golden Rules” applicable to operations in unconventional oil and gas (UOG).<sup>34</sup> These practices include measurement, disclosure, and engagement with stakeholders; prudent choice of drilling locations; proper well construction designed to protect the environment from wellbore fluids; prudent use of water resources; protection of air quality; and cognizance of the cumulative impacts of UOG development (Figure 7.6). The American Petroleum Institute also publishes standards outlining best practices for all significant activities associated with conventional and unconventional oil and gas development.<sup>36</sup> Analysis and research can help improve understanding of the costs and potential benefits associated with widespread deployment of these practices, and how much they could be improved to reduce risk to the environment in terms of methane (CH<sub>4</sub>) leakage, water quality and quantity, truck traffic, and the subsurface footprint.



### *Protection of Natural Waters (Groundwater)*

Protection of groundwater encompasses a range of biological, chemical, and physical systems for both surface (lakes and streams, as well as near-shore oceans) and subsurface waters (aquifers). Public concern regarding UOG development is related to potential water quality impacts on ecosystems and human well-being. Research opportunities in this area include improved quantitative evaluations of contaminant pathways in water resources that can be used to assess potential human and ecological health effects. Research would also help quantify understanding of water quality impacts over the entire cycle of UOG operations (site preparation, water acquisition, drilling, completion and fracturing, production, wastewater disposal, pipeline construction, and site closure), and how these impacts may vary over time and space and may be attributed to differences in UOG operations.

## Energy-Water Crosscutting Research

Understanding the true impacts of water used and produced during UOG operations is a key challenge. This is important because a small fraction of the estimated 151,000 wastewater injection wells permitted in the United States have documented incidents of felt seismic events resulting from injection activities.<sup>37</sup> A significant increase in these seismic events has been observed in central Oklahoma that is inconsistent with any natural processes; this increase is likely the result of wastewater injection associated with a rapid growth in oil and gas production.

RDD&D opportunities include reducing water use in UOG activities; such as developing treatment technologies for wastewater reuse or recycle. Understanding physical subsurface conditions and mitigation strategies that affect seismic events related to wastewater injection is essential.

DOE has established an integrated technology team, the Energy Water Technology Team, to identify and pursue crosscutting technology, data, modeling, analysis, and policy priorities relevant to the issues that crosscut energy production and water availability, use, treatment, and reuse.

### *Efficient and Reduced Use of Water*

Water is used in the drilling, completion, and stimulation (i.e. hydraulic fracturing) of oil and gas wells. Sometimes large volumes of water are produced with the oil and gas. Key challenges include understanding the true impacts of water withdrawn from surface and groundwater systems, and water produced during the active phase of a UOG operation. Produced and flowback wastewaters are important because instead of injection as wastewater,<sup>38</sup> they can potentially be reused for drilling or in hydraulic fracturing, thereby reducing total freshwater withdrawals. They may also be treated and returned to the environment, potentially reducing demands on the local water budget. Water coproduced with oil and natural gas can range from relatively clean to a high brine concentration depending on the geological setting in which it exists. Several companies produce water from their oil and gas operations of such a quality that it requires only limited treatment before it can be reused to hydraulically fracture other wells or for other production operations activities. Research questions relate to how UOG activities may: impact the quantity and availability of water required for hydraulic fracturing; possibly contaminate drinking water resources; and how new technology can mitigate or otherwise reduce the impact on ground and surface water resources. Research challenges and opportunities exist in a number of areas, including alternative water sources, reducing the volume of water used during hydraulic fracturing, technologies and approaches for beneficial treatments of produced water, and low-water to waterless hydraulic fracturing techniques.



### Waterless Stimulation

Several hydraulic fracturing methods that have been investigated in the past decades use little or no water, and some have been adopted into commercial practice. According to data contained in the *FracFocus* database, 609 stimulations were performed using compressed gases in the 2011–2012 time frame (less than 2%–3% of the hydraulic fracturing in the United States and 20%–30% of the hydraulic fracturing performed in Canada). Even though nitrogen- and carbon dioxide-based stimulation methods have been available since the 1970s, they still represent a niche share of the market. “Waterless” hydraulic fracturing fluids and techniques include nitrogen-based foam, CO<sub>2</sub>-based foam, CO<sub>2</sub>-sand fracturing, straight nitrogen- or straight CO<sub>2</sub>-based fracturing, gelled liquefied petroleum gas (LPG) fracturing, and liquefied natural gas (LNG) fracturing. Each has its own strengths, limitations, and costs. Continued RDD&D into improving the environmental performance and cost of these techniques could yield major environmental benefits.

## Subsurface Crosscutting Research

The many oil and gas wells that have been drilled to date have contributed immensely to current understanding of subsurface environments. Shared interests, for example, include wellbore integrity, which is important in subsurface extraction of resources, energy storage, disposition of civilian and defense waste streams, and the remediation of sites contaminated from past endeavors. Future oil and gas development would benefit from additional knowledge of the subsurface stress state in order to predict and control the growth of hydraulically induced fractures, re-opening of faults, and address concerns related to induced seismicity. Current capabilities to measure or infer the *in situ* stress directly do not provide a detailed picture of the variations in stress throughout the subsurface. To guide and optimize sustainable energy strategies while simultaneously reducing the environmental risk of subsurface injection, radically new approaches could help quantify the subsurface stress regime. DOE has established an integrated technology team—Subsurface Technology and Engineering Research—that includes the DOE offices involved in subsurface activities that are aligned with energy production/extraction, subsurface storage of energy and CO<sub>2</sub>, subsurface waste disposal, and environmental remediation.

## Other Environmental Challenges for Unconventional Oil and Gas

### Induced Seismicity

During 2014, Oklahoma surpassed Alaska and California in the number of annual earthquakes. Geophysicists have long known about the potential for human activity to cause seismic activity, from petroleum extraction to water reservoir impoundments and fluid injection into the subsurface. Changes in fluid volume and pore pressure through fluid injection can induce, and in fact, have induced, seismic events. Thus, the three stages of the UOG life cycle that could potentially cause such events are: 1) the disposal of UOG-produced and flowback wastewaters via deep injection wells, 2) long-term extraction of oil and gas, and 3) large-stage hydraulic fracturing. Current understanding suggests that the potential risk of felt or damaging earthquakes is greatest from wastewater disposal in deep injection wells.<sup>39</sup> Induced seismicity can also occur during other activities, such as enhanced geothermal systems and carbon dioxide, development, storage and operations. There is a need for more data and analysis to relate UOG operations to induced seismic events, to connect these events to specific operational parameters and geologic conditions, and to develop and assess possible mitigation options for use by technical and/or regulatory decision makers in an attempt to minimize seismic risks.

### *Truck Traffic and Alternatives*

UOG development sometimes occurs near communities previously unfamiliar with oil and gas operations. UOG operations involve the transport of equipment, fluids, and other materials, usually by trucks. As a result, truck traffic increases significantly in communities where increased developmental activities occur. The largest contributor to this increased truck traffic is the transportation of fracturing fluids to fields and produced water to disposal sites. Associated with increased truck traffic is increased noise, dust, and air emissions from the trucks. Community engagement can be important for mitigating community concerns. Research is needed to develop alternative methods of transporting fluids, technologies that use less or no water, and pollution and noise mitigation technologies.

### *Control of Methane Leaks*

CH<sub>4</sub> leakage during the production, distribution, and use of natural gas has the potential to undermine and possibly even reverse the GHG advantage that natural gas has over coal or oil.<sup>40</sup> This is because CH<sub>4</sub> is a potent GHG. Methane's lifetime in the atmosphere is much shorter than CO<sub>2</sub>, but CH<sub>4</sub> traps more radiation than CO<sub>2</sub>. The comparative impact of CH<sub>4</sub> on climate change is more than twenty times greater than CO<sub>2</sub> over a one hundred-year period<sup>41</sup> and eighty-six times greater over a twenty-year period.<sup>42</sup> The U.S. Environmental Protection Agency's (EPA) national *Greenhouse Gas Inventory* estimates that in 2012, CH<sub>4</sub> contributed roughly 10% of gross GHG emissions (on a CO<sub>2</sub>-equivalent basis) from U.S. anthropogenic sources, nearly one quarter of which were emitted by natural gas systems.<sup>43</sup> R&D to resolve these emissions sources with unambiguous and reconciled data is needed. Beyond that, technology is needed to reduce CH<sub>4</sub> leaks associated with pipelines and compressors in the midstream infrastructure, and to increase the operational efficiency of natural gas infrastructure as a whole. Research opportunities include improved pipeline inspection technologies; external monitoring technologies and real-time leak detection including sensors; "live" pipeline repair technologies; improved gas compression and compressor controls, and response time to changing demand profiles; and gas storage alternatives.

## Flaring of Associated Natural Gas<sup>40</sup>

Some tight oil production tends to be gas rich. Increased flaring occurs when associated natural gas cannot be economically captured and used (often due to lack of infrastructure). As a result, North Dakota has been flaring 30% or more of all the gas produced in the state. In comparison, the national average for gas flaring is less than 1% of marketed production. Flaring of associated gas from oil production is often allowed so that oil production can start, subsequent revenues can flow, associated taxes and fees can be paid, and prospective gas volumes can be estimated. Where appropriate, gas infrastructure—gathering lines, processing plants, and compressors—can be planned and eventually built.

New technologies that could use and convert into useful products methane that might otherwise be flared, remain an important technology challenge and RDD&D opportunity.

### *Reducing Subsurface Footprint*

Near- and long-term, cumulative environmental impacts of UOG development are dependent largely on the nature and pace of the development process and the geologic and geographic setting where development occurs. At present, industry is striving to increase the low recovery efficiencies typical of UOG development by employing increasingly intensive activities, including more closely spaced wells, stacked wells, and more

fracture stages per wellbore. Technological solutions that enable a prudent balance of maximum recovery efficiency with minimum development intensity require research. These include fit-for-purpose simulation tools, novel stimulation technologies (e.g., energetic stimulation materials), and improved process control systems. Such technology will need to be based on an improved scientific understanding of the fundamental nature of UOG reservoirs as well as the processes that govern the storage, release, and flow of hydrocarbons in response to alternative stimulation designs and approaches.

### Emerging Research Opportunities for Offshore Oil Spill Prevention

The offshore environment can be characterized by geologic, meteorologic, oceanographic, and hydrologic uncertainties that require better understanding to reduce the risk to the environment during oil and gas resource development. In the Gulf of Mexico, water depths of greater than 1,000 feet create substantial logistical and operational challenges. In the Arctic, extreme cold creates surface ice and other logistical issues (e.g., oil flow). Spill prevention is very important, and technologies are needed that ensure well control. A more detailed understanding of the geologic environment where hydrocarbons exist could prevent hazards from leading to failures. Technologies and processes that protect the environment during the drilling and completion of wells and the umbilicals and systems that bring the production to the surface could minimize potential environmental damage. Increased reliability of subsea systems could reduce both cost and environmental risks.

For example, protection of the environment at and below the seafloor during drilling and completion could be improved with novel designs and materials for better wellbore integrity, comprehensive knowledge of wellbore intervention and remediation technologies (pre- and post-decommissioning), and the advancement of capabilities for human interface with sophisticated technology and monitoring systems. Challenges associated with surface systems and umbilicals include large-scale system designs and technology to improve safety and long-term durability, and to increase automation in support of decision making.

As discussed in the recent NPC study *Arctic Potential*,<sup>44</sup> spill prevention is especially important in avoiding the need to implement a spill response in Arctic waters. Research priorities are similar to those for offshore Gulf of Mexico except that surface temperatures and the presence of ice require enhancements to surface systems and equipment to address drilling and production in extreme environments.

### Gas Hydrates: Assessment and Safe and Effective Production

Gas hydrate is a material very much tied to its environment—it requires very specific conditions to form and remain stable. Pressure, temperature, and availability of sufficient quantities of water and CH<sub>4</sub> are the primary factors controlling gas hydrate formation and stability, although geochemistry and the type of sediment also play a part. If the pressure and temperature are just right, free methane gas and water will form and sustain solid gas hydrate. Gas hydrates can be found in pipelines, in the subsurface, and on the seafloor.

Despite being a large resource (Figure 7.5), gas hydrates are far from a viable option for meeting potential domestic energy supply needs in the mid-term. To tap this resource, science and technology advancement on three fronts would be needed. First, the United States' resource must be more fully characterized and confirmed to better understand the opportunity and challenges. While the assessment of gas hydrate onshore in Alaska is relatively advanced, the bulk of the resource lies offshore. Although a joint industry drilling program by DOE, the U.S. Geological Survey (USGS) and the Bureau of Ocean Energy Management (BOEM), confirmed gas hydrate resource occurrence and exploration approaches in 2009,<sup>45</sup> these represent the only wells to validate the BOEM assessment of ~20,000 Tcf of resource-grade gas in the United States' Outer Continental Shelf.<sup>46</sup> This estimate is an order of magnitude more gas than the entire United States' technically recoverable natural gas resource base.<sup>47</sup>

Second, production approaches demonstrated over sufficient time frames can generate reliable estimates of gas/water production. Multiple long-term tests would identify and provide insight into potential production issues (such as sand production, seal integrity, and others). While depressurization will be the base technology for commercial applications, the optimal use of chemical, mechanical, and thermal stimulation could affect site-specific production levels significantly. Initial field experiments are likely to occur in the Arctic, with lessons learned subsequently demonstrated in the deepwater of the Gulf of Mexico. Commercial applications will also likely leverage drilling approaches tailored to the shallow depths at which gas hydrate occurs.

Third, concerns regarding gas hydrate's potential contribution to ongoing climate change must be addressed through continued integration of gas hydrate science into ocean process and global climate models. Gas hydrate geohazard issues, particularly on shallow arctic shelves, are an area of increasing concern.

There is currently little or no domestic industry investment in this area, either on a proprietary basis, or in collaboration with government. Effective collaboration between federal and state research, international research programs, and government agencies would improve any future research in this area.

In summary, the oil and gas sector has undergone significant changes due in large part to advanced technologies. Oil and gas are relatively low cost and represent a large, secure domestic resource. However, to ensure prudent development of the U.S. oil and gas resource base both onshore and offshore, technological advances are still needed to address the remaining challenges.

For UOG, this includes improving water and air quality, reducing the surface and subsurface footprint, and addressing induced seismicity. For water, the concern is protecting groundwater, reducing the amount of water used in UOG development, efficient use of water, and water-less stimulation. For induced seismicity, we need to understand the specific relationship between seismic events and UOG operations—is it related to the disposal of wastewater? Is it related to the size of the hydraulic fracturing treatment? Can faults be identified before they move? We need to understand these relationships and their mechanisms in order to predict and mitigate induced seismicity. Another important challenge is the intensity of development of UOG. The low recovery factor from these wells is leading to more frequent and more intensive stimulation. Understanding the scale and nature of UOG formations could help reduce this intensity, which in turn could lead to many environmental benefits, such as fewer wells, reduced water use, reduced truck traffic, and improved air quality.

Moving to the offshore, the challenges are associated with the complexity of dealing with deep water and deep formations in the Gulf of Mexico, and surface temperatures and ice in the Arctic. The technology opportunity space for oil spill prevention in the Gulf of Mexico includes understanding the geologic hazards in the subsurface before the drilling program is designed, and then being able to handle any anomalies during drilling. This intersection of the natural system with the engineered systems is the point of highest risk in oil and gas development. This risk is exacerbated when drilling through thousands of feet of water into pay zones that can be miles deep and located more than one hundred miles from shore. Once the well is in production, the risk continues. The umbilicals and the surface systems are subject to hurricanes on the surface, and to currents and corrosion subsea. Finally, many of the subsea and seafloor systems are automated, so reliability of the components is critical. Arctic development has significant challenges due to low temperatures, ice, and the remoteness of the location. The recent NPC study *Arctic Potential*<sup>48</sup> advises of the need “to validate technologies for improved well control...”

The issues affecting future supply from gas hydrates focus on two main concerns: 1) how to commercially produce certain hydrate deposits and 2) how to identify the conditions for stability of noncommercial hydrate deposits. The technology space to address these concerns is framed by three key thrusts: 1) characterization of the resource, 2) production approaches for commercial deposits, and 3) conditions of hydrate stability for noncommercial deposits.

Underlying all of these is the need to address carbon emissions to the atmosphere. Technology can help overcome some of the shortcomings associated with oil and gas during the transition to a low-carbon economy. More information on oil and gas is included in the Supplemental Information to this chapter.

## Federal Roles

The oil and gas industry is a mature, worldwide commercial entity. The federal role in this enterprise is necessarily focused on ensuring the public good and manifests itself in activities that protect the environment, improve safety, and contribute to the nation's energy security. The federal role includes partnering across industry on such activities as developing technologies in the public domain that can sustain domestic supply, minimize the footprint of operations by reducing the number of wells drilled, protect water and air quality, reduce the risk of oil spills, and mitigate the risk of pipeline leaks and fugitive emissions.

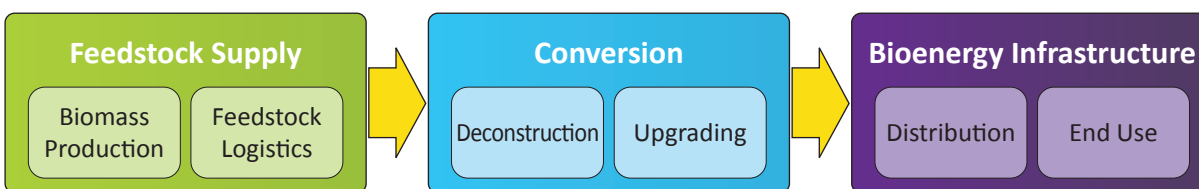
## 7.3 Bioenergy for Fuels and Products

### 7.3.1 Bioenergy Overview

Bioenergy can help meet the need for liquid fuel with lower emissions through production of biofuels and other bioproducts. This requires developing, producing, and collecting sustainable feedstocks, efficient conversion processes, and a competitive final fuel product that has the necessary physical and chemical properties. Properties that are required include appropriate energy content and characteristics for use, acceptable transport characteristics, ability to withstand temperature extremes, and storage suitability.

In general, bioenergy pathways consist of production and collection of feedstock supply; conversion of that feedstock through a wide variety of processes into the desired fuel; and distribution in the energy infrastructure for use (Figure 7.7). In addition, biogenic wastes (e.g., manures, biosolids [treated sewage], food wastes, and municipal solid waste) can be converted into liquid fuels and products. This section describes a variety of technologies across these generalized pathways and associated metrics used to assess the viability and desirability of these technologies.

**Figure 7.7** Overall Pathway for Production of Fuels from Biomass



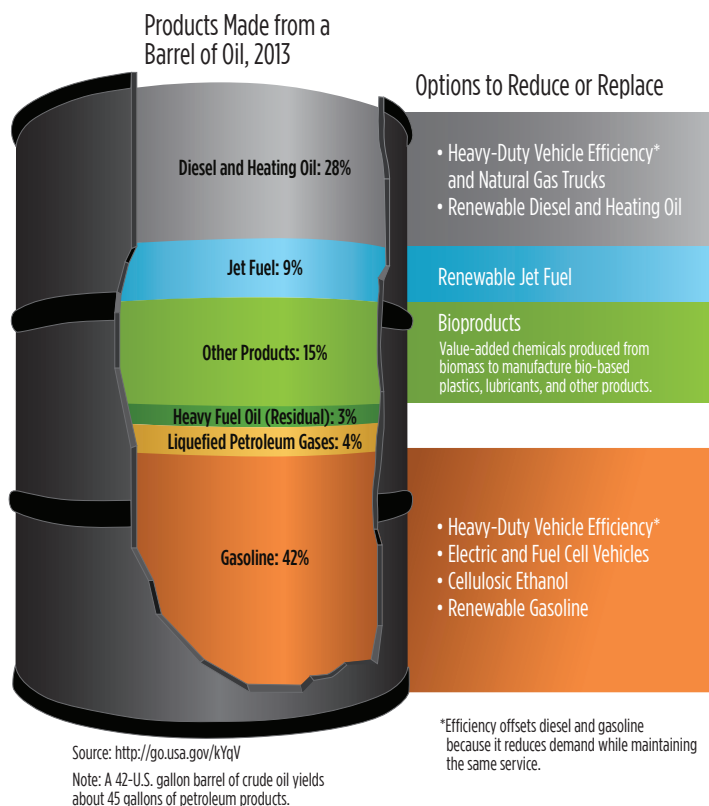
Bioenergy can provide options to replace oil, especially in challenging applications like aircraft fuels, diesel, and bioproducts that can substitute biomass for petroleum feedstocks (Figure 7.8). Renewable fuels are needed for reducing GHG emissions from these sectors because other approaches like electrification are not viable in the near term. A fuel that is compatible with existing infrastructure may increase the ability of the fuel to serve many needs and reduce barriers to deployment.

Bioenergy is considered renewable because it can be replenished through plant growth or use of waste streams. Carbon dioxide emitted from biofuel combustion is generally discounted as an emission because it was captured from the atmosphere in growing the biomass. Cultivation, production, collection, and processing of biomass into fuels and products often involves the use of fossil fuels, which means the resulting life-cycle

**Figure 7.8** R&D options are available to address most products from the whole barrel of oil. Bioenergy can address jet fuel and other products, two fractions that have few other substitutes.

Credit: U.S. Energy Information Administration

## Reducing and Replacing Petroleum Use



energy may not be completely renewable or emissions-free. Growth of biomass may also impact soil carbon or standing biomass. Challenges associated with large-scale utilization of biomass include the need for a large land area to grow biomass feedstocks, water and nutrient requirements for feedstock cultivation, and the impact of feedstock growth because of climate issues.

Life-cycle assessment (LCA) is a technique used to evaluate total energy use and GHG emissions associated with biofuels and compare energy pathway performances. Pathway emissions depend on factors such as the energy needs of the feedstock, logistics energy use, fertilizer requirements, conversion efficiency and chemistry, and biorefinery energy needs. R&D can identify ways to improve the conversion efficiency for many pathways. Fuels under development can reduce the life-cycle emissions

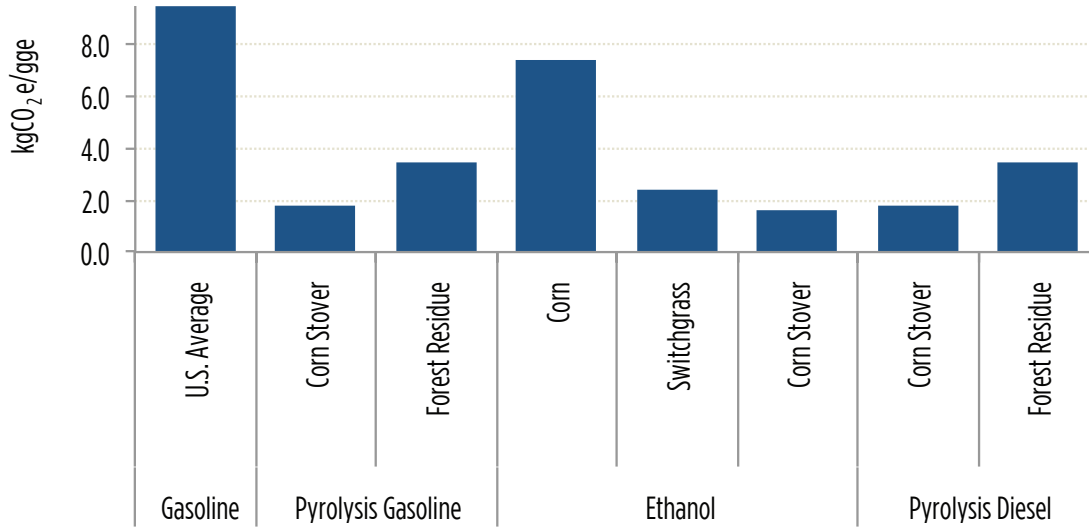
of GHGs in comparison to existing fossil-derived transportation fuels (Figure 7.10). Some topics, such as land-use change, can be challenging to include in an LCA framework and are a subject of ongoing research.

### Total Bioenergy Potential

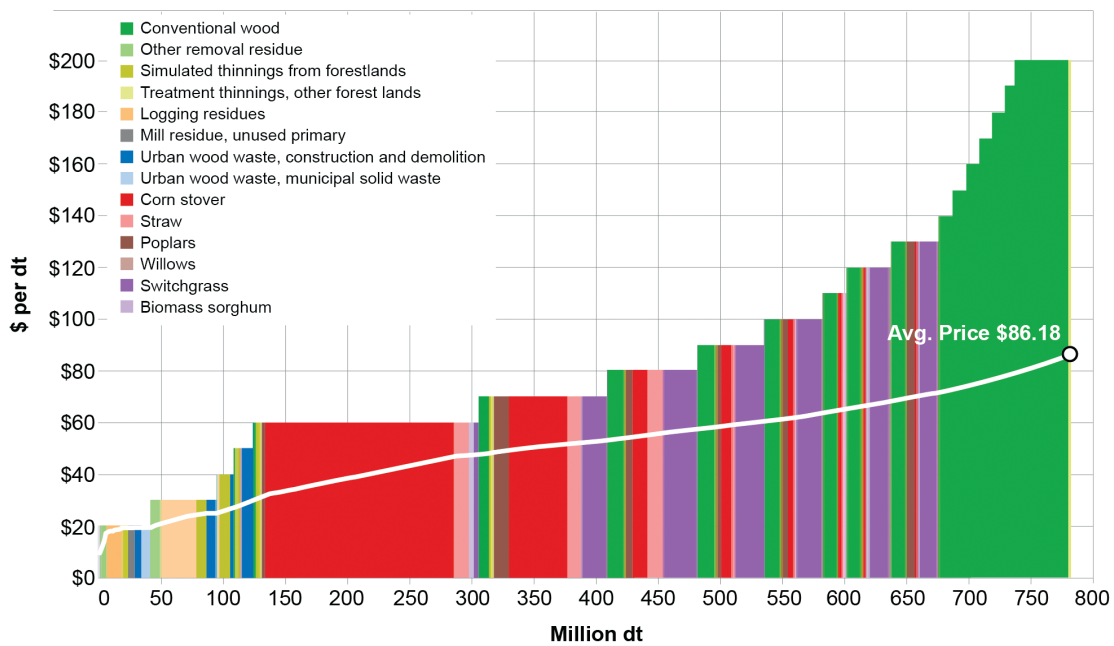
The total emissions reductions and petroleum displacement potential of biofuels and hydrogen depend on factors such as the total sustainable resource, the availability of a cost-effective resource, and the efficiency of conversion technologies (Figure 7.9). More than one billion dry tons of biomass may be available sustainably for use as bioenergy by 2030 (Figure 7.10 and Table 7.3).<sup>49</sup> With technology improvement and a mature market, this available bioenergy could provide approximately 58 billion gallons of fuels to replace gasoline, diesel, and jet fuel—produced from approximately 18 quadrillion British thermal units (Btu) of biomass feedstock by 2050.<sup>50</sup> Capturing this total potential would require significant success in RD&D and market deployment activities.

Even in high-usage scenarios, bioenergy would not supply sufficient energy to totally replace petroleum at current use levels. However, when combined with efficiency and other strategies in transportation (Chapter 8) and industry (Chapter 6), bioenergy can represent a key part of a clean energy future, especially by meeting

**Figure 7.9** Life-Cycle Greenhouse Gas Emissions of Selected Pathways. These are point estimates but significant uncertainty and geographic variation remains regarding the specific emissions associated with each technology or specific biorefinery. Data from Greenhouse Gases, Regulated Emissions and Energy Use in Transportation Model (GREET 2014).



**Figure 7.10** Total Estimated Sustainable Bioenergy Resource Potential Supply Curve at Marginal Prices Between \$20 and \$200 per Dry Metric Ton in 2022



**Table 7.3** Current and Future Potential Impacts of the Bioeconomy. As one possible scenario of potential biomass use in the future, the 2030 vision for the bioeconomy uses one billion dry metric tonnes of biomass—approximately 18 quads of primary energy—to produce the power, fuels, chemicals, and pellets listed below. The biofuels allocation is 14.6 billion gallons of ethanol, 21.8 billion gallons of advanced drop-in fuels, 5.5 billion gallons of jet/aviation fuels, and 15.9 billion gallons of diesel and heating oil, for a total of 58 billion gallons of liquid fuels, which would represent approximately 20% of current total annual petroleum use. Power generation of 90 billion kWh would represent about 2.5% of current electricity generation.<sup>51</sup>

Bioeconomy parameter	Current	Future potential
Biomass utilization	200 million dry metric tons (DMT)	1 billion DMT
Biopower production	30 billion kWh	90 billion kWh
	(22 million DMT)	(60 million DMT)
Biofuels production	15 billion gallons	58 billion gallons
	(164 million DMT)	(918 million DMT)
Biochemicals production	2.5 billion pounds	16 billion pounds
	(7 million DMT)	(44 million DMT)
Wood pellet production	14 billion pounds	34 billion pounds
	(7 million DMT)	(17 million DMT)

liquid fuel needs in uses like jet fuel that are challenging to replace. Conversion technologies need to be developed utilizing lignocellulosic feedstocks, waste materials, and algae that minimize land-use change and deforestation around the world.

### Impact of Success: Growing the Bioeconomy

The bioeconomy has potential to provide jobs and economic opportunities, support a secure, renewable energy future, and contribute to improved environmental quality. While the United States has always maintained an active bioeconomy, the potential exists to expand it and use up to one billion dry tons of biomass annually producing renewable fuels, power, and products. This effort would require sustainable production of biomass feedstocks, construction of biorefineries and manufacturing facilities, market growth in biofuels and other biomass-derived products, and development of feedstock production to support the industry. Table 7.3 shows the current and anticipated outcomes from a fully mature bioeconomy.

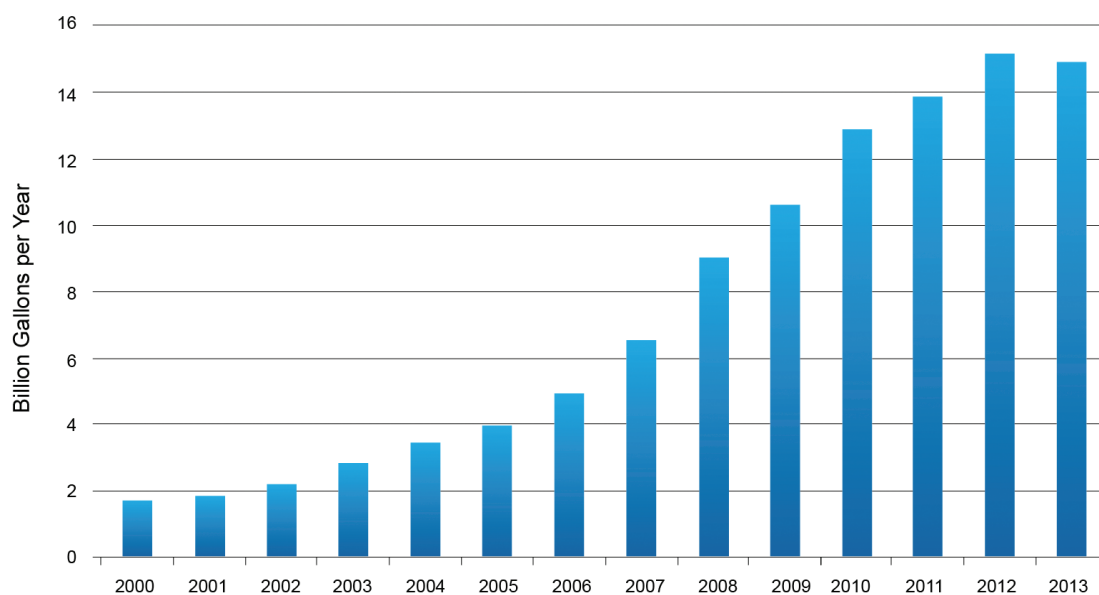
Increasing utilization of a diverse blend of domestic resources including, renewable fuels such as biofuels, offers a pathway to increase energy security and reduce market uncertainty by increasing diversity.

#### 7.3.2 Current Status

While not as extensive as petroleum-based systems, biofuels have established markets, infrastructure, and industrial processes for production and use in the United States and worldwide. In some parts of the world, biofuels are competitive as a drop-in transportation fuel. In 2013, the United States produced 13.5 billion gallons of ethanol from 211 biorefineries for use as a transportation fuel. This development has scaled up rapidly from less than two billion gallons of capacity in 2000 (Figure 7.11).



**Figure 7.11** Growth in U.S. Ethanol Production Capacity (Source: Bioenergy Technology Office Multi Year Program Plan)<sup>52</sup>



Ethanol from corn remains the largest component of this market. It is consumed in the light-duty vehicle fleet as blends of ethanol/gasoline. Approved blends in the United States' market are E10 (10% ethanol, 90% gasoline, suitable for most vehicles in the road today), E15 (for 2001 and newer light-duty vehicles), and E85 (for flex-fuel vehicles). Biodiesel from soybean and waste oils is also being used in heavy-duty vehicles at blends up to B20, displacing approximately 2% of the diesel market.

Cellulosic biofuels, mandated by the Federal Renewable Fuel Standard and favored by the California Low Carbon Fuel Standard<sup>53</sup> have been slower to enter the market. Recently, there has been significant R&D progress that should lead to reductions in the production cost of biochemically produced cellulosic ethanol. To realize the benefits of this technology, more plants must be built at commercial scale (approximately 50 million gallons per year), and the current technologies must mature as the industry gains experience.

Four commercial-scale facilities have been constructed that can produce ethanol from lignocellulosic feedstocks (Abengoa—25 million gallons per year, DuPont—30 million gallons per year, INEOS—8 million gallons per year, and POET-DSM—25 million gallons per year). These facilities convert corn stover, citrus waste, and other types of agricultural residues into ethanol. Although these accomplishments are substantial and represent important benchmarks for technology demonstration, they remain a small part of the fuels market.

Three additional commercial-scale cellulosic biofuel projects (Emerald Biofuels, Fulcrum BioEnergy, and Red Rock Biofuels)<sup>54</sup> are in the construction phase. These projects will use municipal solid waste, waste oils and greases, and woody biomass to produce renewable jet fuel and renewable diesel. These fuels are nearly identical to their fossil-derived counterparts and are approved for blending at 50/50 levels with conventional jet fuel/diesel in the civil and military aviation sectors. Production from these facilities is expected to begin in 2017, and when fully operational, they will produce 100 million gallons/year of renewable diesel and jet fuel.

Despite recent progress, key barriers remain for advanced bioenergy technologies. Although there are more than seventeen million vehicles on the road that can use E85, various factors have limited E85 use in practice, and E15 is not yet widely deployed. This means that additional ethanol cannot simply be added to the fuel mix beyond the current 10%.

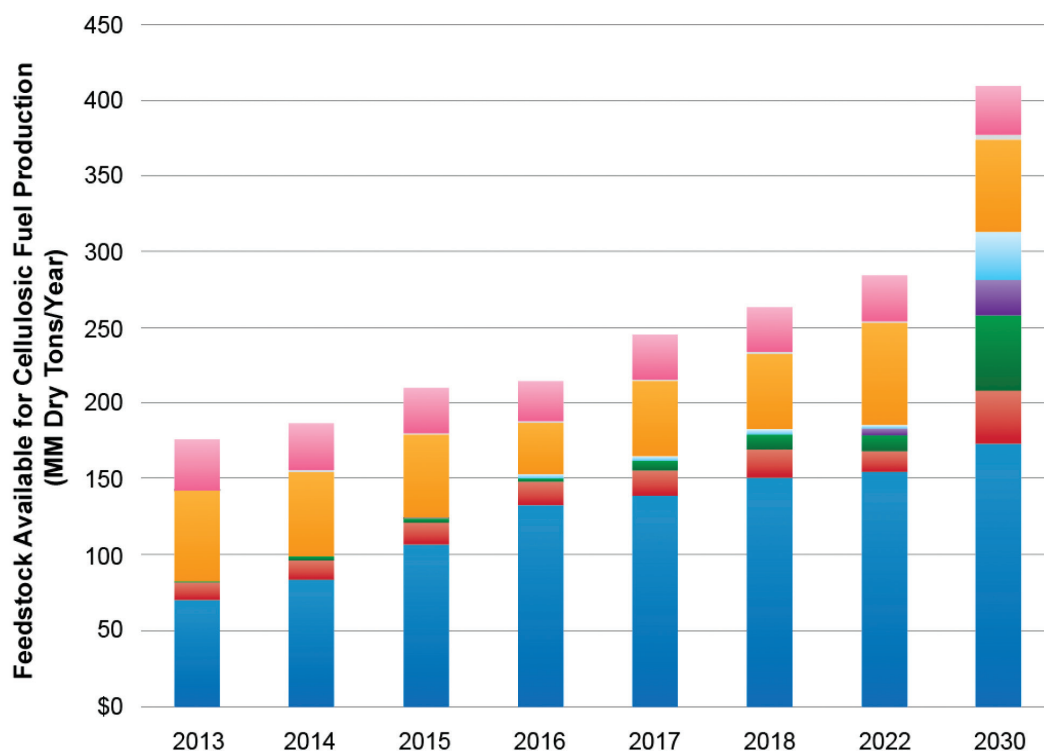
### 7.3.3 Feedstocks and Logistics

The sustainable supply of quality, cost-effective feedstocks is fundamental to growing the bioenergy industry. However, the inherently dispersed nature of biomass remains a central challenge. Four broad categories of feedstock are discussed here: 1) terrestrial feedstocks, 2) lignin, 3) algal feedstocks, and 4) waste feedstocks.

#### Terrestrial Feedstocks

About 200 million dry tons of biomass is currently used today. The largest energy use of biomass (44%) is in the industrial sector where wood/wood waste is used in paper mills to provide heat and steam via boilers. The transportation sector uses the next largest share of biomass (31%) in the form of corn-based ethanol and soybean-waste oils-based biodiesel. Corn and soybean harvesting, logistics, and collection systems are mature following many years of fine-tuning and development. The remaining biomass consumption is fuelwood in residential and commercial sectors. A small amount of biomass is consumed by the electric power sector. About 65% of the biomass is woody material and comes from forest sources. The delivered price for pulpwood ranges from \$30–\$40/green ton (Figure 7.12).

**Figure 7.12** Historical and Projected Volumes of Biomass Available at a Delivered Cost of \$80/Dry Metric Ton for Various Biomass Types, Accommodating Multiple Conversion Processes. NOTE: Higher projected volumes are attributable to a variety of factors, including increased biomass yields, capacity and efficiency improvements in logistics systems, and logistics strategies such as blending.



Today, a quality, affordable feedstock supply uses conventional logistics systems developed for traditional agriculture and forestry systems. These are designed to move biomass short distances for limited-time storage (less than one year). It appears that such systems are not well configured for a diverse, much larger set of feedstocks and their associated transportation requirements, especially in medium-to-low yield areas. Advanced, purpose-designed, economical systems designed to deliver feedstocks with predictable physical

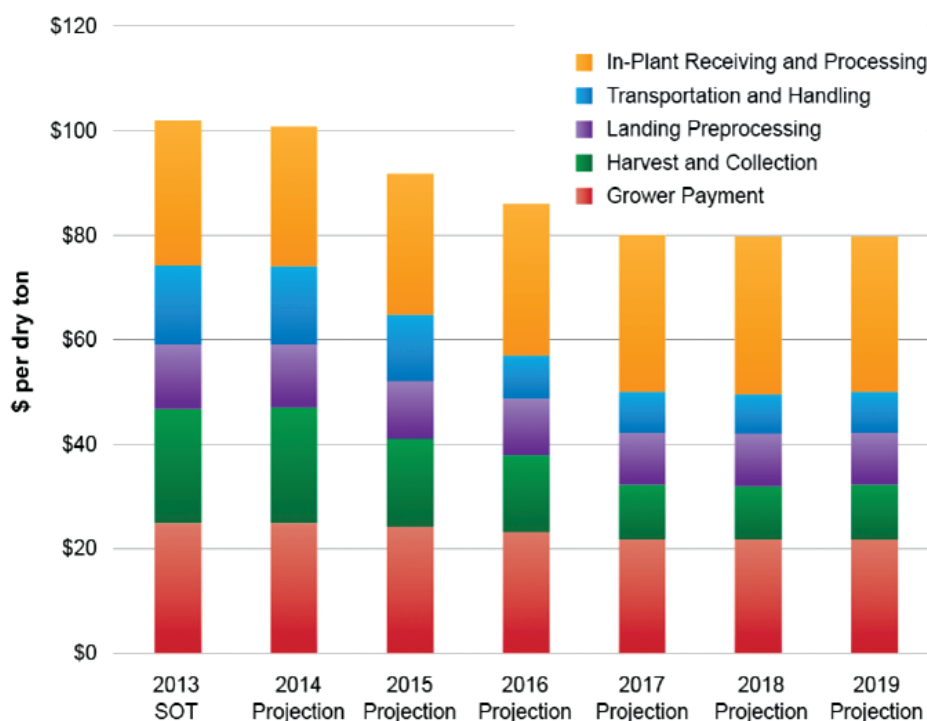
and chemical characteristics, longer-term stability during storage, and high-capacity bulk material handling characteristics can facilitate economic transport over longer distances and lower costs of biofuels. One approach to achieving this is applying preprocessing techniques, such as blending.<sup>55</sup>

Energy crops are produced primarily to be feedstocks for energy production—as opposed to agricultural or forest residue, which are byproducts of another commodity. Examples of energy crops include switchgrass, miscanthus, and energy cane. Farmgate price is defined as the price needed for biomass producers to supply biomass to the roadside. It includes, when appropriate, planting, maintenance (e.g., fertilization, weed control, pest management), harvest, and transport of biomass in the form of bales or chips (or other appropriate forms—e.g., billets, bundles) to the farmgate or forest landing.

Biomass price projections with quality information obtained from the Biomass Resource Library and Properties Database<sup>56</sup> have shown that gains in projected volumes can be realized by transitioning to a blended feedstock approach.

Traditionally, terrestrial feedstock logistics research has focused on improving conventional systems. Through 2012, conventional woody supply system costs were reduced by improving existing equipment efficiencies, adopting innovative ways of mitigating moisture content, and increasing grinder performance. Many researchers have since concluded that conventional feedstock supply systems would remain inadequate for a competitive biofuels industry, and focused on advanced logistical systems and nonideal feedstock supply areas to increase the total volume of material that could be processed, enable more biorefinery options, address quality, and meet the 2017 cost target of \$80 per dry ton delivered to the biorefinery inlet. Advanced systems could gradually bring in larger quantities of feedstock from an even broader resource base after 2017, as well as incorporate environmental impact criteria into availability determinations and continue to meet both quality requirements and the \$80 per dry ton cost target (Figure 7.13).

**Figure 7.13** Historical and Projected Delivered Woody Feedstock Costs, Modeled for Pyrolysis Conversion



Key: SOT = State of technology

A feedstock cost target of \$80 per dry ton is estimated to be sufficient to supply biomass that meets a set of required specifications (ash content, moisture, particle size distribution, amount of material) for fuel conversion facilities.<sup>57</sup> The cost includes a grower payment to the farmer to reflect the added inputs needed to grow and/or harvest the material. A conversion facility can expect to achieve an efficiency of about 70 gallons of fuel/dry ton. Feedstock cost of \$80 per dry metric ton adds about \$1.14 per gallon to the fuel conversion cost.

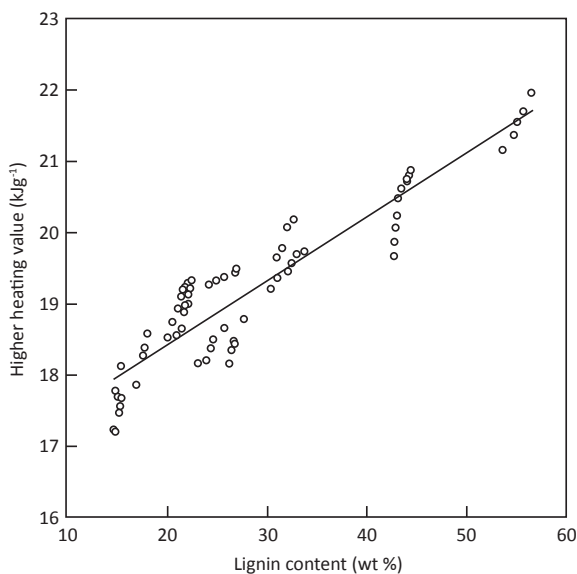
## Lignin

Lignin is a large molecule and component of woody biomass cell walls that gives wood its distinctive structure. A total resource availability of 300 billion metric tons of lignin exists in the biosphere,<sup>58</sup> making it one of the most abundant natural polymers on Earth. Assuming an energy content of 25 kJ/g, the renewable resource is equivalent to nearly 8,000 quads worldwide. Of course, only a small fraction of this energy can be used for bioenergy or bioproducts.

Burning wood for heat energy is among the oldest forms of human energy use. Commercial experience with lignin is also long-lived; in 1927, the Marathon Corporation began investigation into commercial uses for lignin other than as boiler fuel. Successive uses have included a diverse slate of products, from bulk chemicals like agricultural dispersants to specialty chemicals like vanillin. Other companies have recently developed injection molding substances from lignin (Tecnaro GmbH) and produced expanded polyurethane foam using lignin.

**Figure 7.14** Correlation Between Lignin and Energy Content in Biomass Samples<sup>59</sup>

Credit: Reprinted from *Energy Conversion and Management*, 42, Demirbas, A., Relationships between lignin contents and heating values of biomass, 183-188, Copyright (2001), with permission from Elsevier.



The higher heating value (HHV) of different types of biomass samples correlates with the sample's lignin content (Figure 7.14). For biofuel production, particularly through biochemical conversion technology routes, lignin is often an under-utilized biomass component due its digestion resistance. Most often it is used on-site at the biorefinery to generate energy and process heat. Lignin can make up as little as 15% of herbaceous plant composite and as high as 35% of some softwood species. Lignin is too high of a percentage of biomass to ignore for biofuel cost-competitiveness.

One solution to costs and logistical issues is blending. Feedstock blending allows a biorefinery to collect less of any one feedstock and thus move down the cost versus supply curve, enabling biorefineries to pay a lower average price. The blended feedstock concept is being explored by two lignocellulosic biomass conversion facilities: Abengoa in Kansas and POET in Iowa. Preliminary results suggest that blending multiple preprocessed feedstocks enables the acquisition of higher biomass volumes and reduces feedstock variability to meet biorefinery in-feed specifications, while delivering feedstock to the biorefinery at \$80/dry metric ton.

## Algae

Algal biomass includes micro- and macro-algae and cyanobacteria, all abundant in the earth's oceans and freshwater causeways. Because algae grow rapidly, and thus potentially could scale as a commercial feedstock, biofuels derived from algal biomass could contribute to a substantial domestic advanced biofuel market. Advantages of algae-derived biofuels include the ability to grow on nonarable land (including potentially offshore) and the ability to use brackish or saline water and grow on waste nutrients and effluents, including carbon dioxide from power plants. Algae may also have a limited concentration of ash (the inorganic components of biomass) and can accumulate significant amounts of lipid.

This high-lipid content has special merit for biorefining. Algal species that accumulate significant amounts of lipid in their cell structure are particularly well suited for economic conversion to hydrocarbon-based fuels such as renewable diesel and jet fuel. Research has the potential both to increase algal growth rates and maximize lipid content. However, algae have their own challenges. Depending on the setting and production system, production costs can be very high, and both water and micronutrient requirements can be substantial. R&D opportunities include reducing the cost of production of algal biomass and intermediates, developing cultivation and logistics systems for producing fuels and products at commercial scale, developing innovative dewatering technologies, and developing algal species that can survive and maintain high productivity in nonlined open pond algal farms. These costs must be substantially reduced for viable commercial competitiveness.<sup>60</sup>

Table 7.4 shows projected minimum fuel selling prices for algae-based biofuels based on reasonable yield assumptions derived from literature and technical projections. The greatest opportunity to reduce costs is in production systems through improved biomass yield and reduced cultivation capital costs. Achieving the 2022 projection requires the following: a fivefold improvement in biomass yield through increased productivity and extractable lipid content, a factor of two reduction in capital costs for pond construction (including removing pond liners from the design), and significant capital and operability improvements in the harvest and preprocessing steps.

**Table 7.4** Summary of Cost Contributions (\$/gallon of product) for the Algal Lipid Upgrading Design<sup>61</sup>

Unit operation	2010 state of technology	2014 projection	2018 projection	2022 projection
Feedstock	\$16.50	\$10.60	\$5.19	\$3.05
Conversion	\$1.72	\$1.56	\$1.11	\$1.11
Hydro-treating	\$1.84	\$1.84	\$1.84	\$0.29
Anaerobic digestion	\$0.68	\$0.65	\$0.47	-\$0.18
Balance of plant	\$0.00	\$0.00	\$0.00	\$0.08
<b>Total</b>	<b>\$20.74</b>	<b>\$14.66</b>	<b>\$8.61</b>	<b>\$4.35</b>

## Waste to Fuels

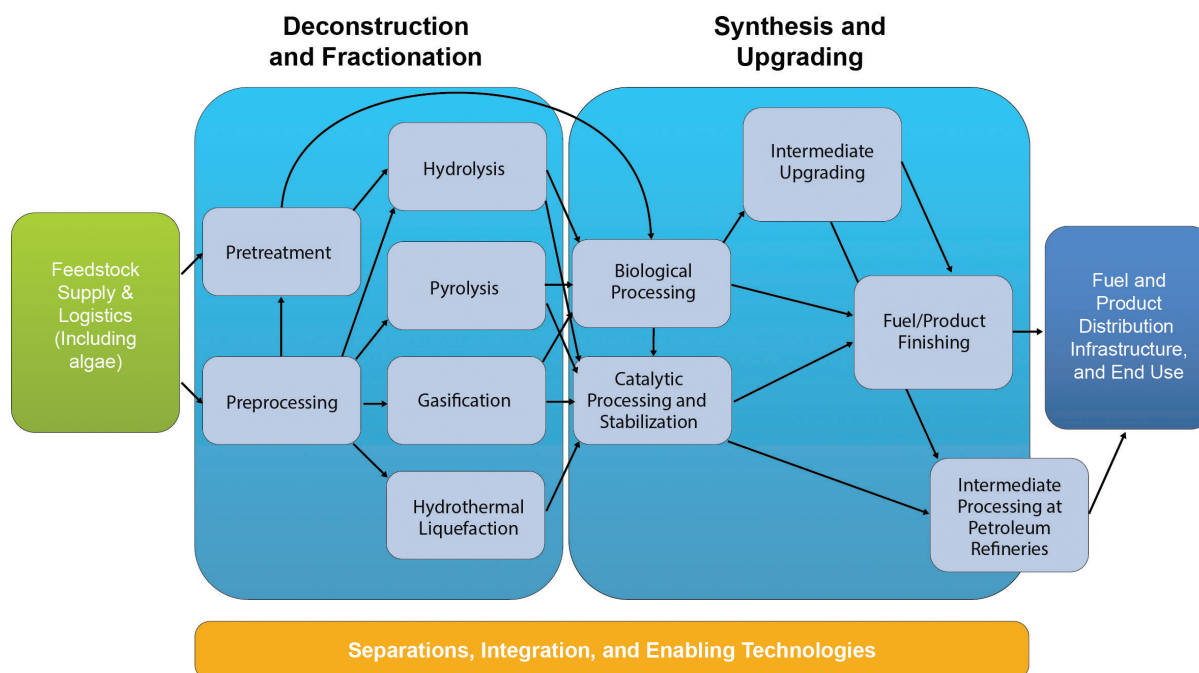
In addition to purpose-grown crops, municipal, industrial, and agricultural waste streams constitute a significant resource for the production of fuels, product precursors, heat, and electricity. Waste feedstocks have an inherently attractive quality—using them likely provides solutions to problems of waste management and disposal. Two facilities in the United States currently convert waste fats, oils, and greases into renewable diesel (Diamond Green Diesel facility in Louisiana—130 million gallons per year and REG’s plant in Geismar, Louisiana—75 million gallons per year of renewable diesel).

The *Biogas Opportunities Roadmap*, issued jointly by the U.S. Department of Agriculture, EPA, and DOE, estimates that the combination of biogas production from agricultural manure operations, landfills, and water resource recovery facilities could yield 654 billion cubic feet per year. If converted to electricity, the roadmap projects potential generation of more than 40 terawatt-hours, more than 1% of the United States’ current consumption according to the EIA. This figure is probably conservative, as it does not include organic industrial wastes. Biogas used in compressed or liquefied natural gas vehicles and biogas used to generate electricity to charge an electric vehicle both qualify as cellulosic biofuels under the Renewable Fuel Standard.

### 7.3.4 Conversion Pathways

Biological feedstocks and their intermediate products (e.g., crude bio-oils, syngas, and sugars) must be upgraded to produce a finished product. These finished products could be fuels or biochemicals, or could be stabilized intermediates suitable for finishing in a petroleum refinery or chemical manufacturing plant. To produce energy-dense, liquid transportation fuels, a variety of conversion technologies are being explored that can be combined into pathways from feedstock to product (Figure 7.15).

Figure 7.15 Conversion Pathways from Feedstock to Products

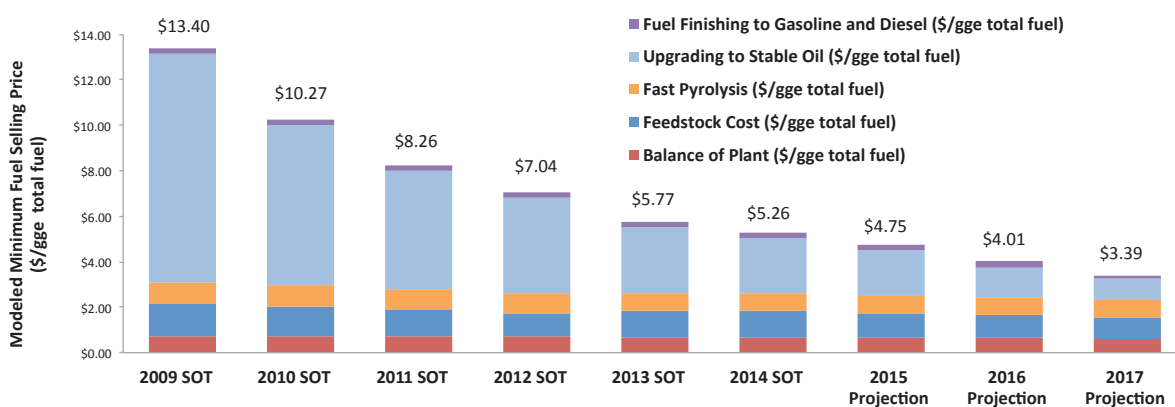


Historically these pathways have been roughly classified as either biochemical (using biological processes such as organisms or enzymes) or thermochemical (using chemical catalysis and chemistry) to reflect the primary catalytic conversion system employed as well as the intermediate building blocks produced. Generally, biochemical conversion technologies involve pathways that use sugars and lignin intermediates, while thermochemical conversion technologies involve pathways that use bio-oil and gaseous intermediates. Specific process variations impact performance (e.g., rate, selectivity, and yield), which determines economic viability and potential environmental impacts (e.g., life-cycle assessments).

## Conversion Process Steps

Conversion can be broken down into two parts: 1) deconstruction and fractionation, and 2) synthesis and upgrading. Figure 7.15 highlights key technologies within deconstruction and fractionation as well as synthesis and upgrading, which are linked to form a complete conversion pathway from feedstock to products. Research on multiple technologies along several pathways can address the broad range of physical and chemical characteristics of various feedstocks and reduce the risk that any specific technology could fail to reach commercial viability. Additionally, each linked set of conversion technologies results in the production of a unique product slate whose value will vary depending on market size and demand.

**Figure 7.16** Cost Projection Breakdown for the Fast Pyrolysis Design Case, 2009–2017



**Deconstruction and fractionation:** Deconstruction and fractionation processes break down biomass-derived polymeric feedstock into tractable intermediate streams. After preprocessing and/or pretreatment, deconstruction processes can be divided into two categories: high-temperature deconstruction (at or above 100°C) and low-temperature deconstruction.

Development of a variety of conversion technologies is necessary to address the broad range of physical and chemical characteristics of various biomass feedstocks. Preprocessing options include densification and blending of an expanded pool of feedstocks, and also impact conversion.

- **High-temperature deconstruction** encompasses pyrolysis, gasification, and hydrothermal liquefaction. Each of these approaches is a conventional chemical engineering process, but application to biomass feedstocks is relatively new, and issues of cost, feed systems, ash handling, and other engineering and material handling topics remain important.
- **Low-temperature deconstruction** is the breakdown of feedstock into intermediates by pretreatment followed by hydrolysis. In this context, pretreatment is the preparation of feedstock for hydrolysis and separation of feedstock into soluble and insoluble components. This process opens up the physical

structure of plant cell walls, revealing sugar polymers and other components. Hydrolysis is the breakdown of these polymers either enzymatically or chemically into their component sugars and/or aromatic monomers.

One conversion method, fast pyrolysis, has made important progress since 2009 and appears on track for market parity prices with ethanol in the next five years. The updated fast pyrolysis design case uses a blended, formatted woody feedstock to produce gasoline and diesel blendstock with costs modeled for n<sup>th</sup> plant biorefineries. This design case illustrates how the \$3 per gallon of gasoline-equivalent cost goal can be achieved by 2017.<sup>62</sup> The waterfall chart in Figure 7.16 shows that a 75% cost reduction is projected to be achieved from the 2009 state of technology (SOT) to the 2017 projection made possible by decreasing bio-oil upgrading costs through R&D efforts in catalyst improvement. In addition to large cost reductions, the renewable blendstocks produced are projected to have GHG reductions of greater than 60% compared to petroleum-based blendstocks.

### Thermochemical Conversion: Fuels and Petrochemicals

The thermochemical process used today for cellulosic conversion is gasification, including a gasifier, syngas cleanup, and catalytic fuel synthesis reactors. Significant process engineering improvements have been achieved within the gasifier and fuel synthesis steps, and technical improvements have been achieved in the syngas cleanup and catalytic fuels synthesis steps. Notable past breakthroughs have included the optimization of an indirectly heated fluidized bed gasifier; the development of tar- and methane-reforming catalysts that increased methane conversion to syngas from 20% to more than 80%; and development of catalysts and operational strategies for the conversion of syngas to mixed alcohols production. These key improvements have resulted in an increase in ethanol yield from 62 gallons to greater than 84 gallons per ton of biomass.

### Bioproducts

There are compelling economic and environmental reasons to pursue the development and manufacturing of biobased chemicals, in addition to fuels. The enabling research, technology development, and commercial demonstration of such technologies in the 1990s and early 2000s yielded substantial progress, outcomes, and commercial successes. These include the DuPont Tate and Lyle's 1,3-propanediol facility in Tennessee, Natureworks' polylactic acid facility in Nebraska, and the Myriant succinic acid facility in Louisiana. Each facility can generate more than a million pounds per year of renewable chemicals, effectively displacing fossil precursors of these materials.

Bioproduct markets are well developed, and the bioproducts compete directly with petroleum counterparts on a basis of cost and purity. Other bioderived chemicals may offer improved functionality compared to petroleum-derived chemicals. Such bioproducts may have an inherently higher value, but their markets will take time to develop, increasing risk.

Because biomass feedstocks are oxygenated compared to petroleum feedstocks, biofuels and many other market chemicals normally require reducing the oxygen content relative to biomass feedstocks. Conversely, other market chemicals are oxygenated—whether they are direct replacements, functional equivalents, or provide new functionality. In fact, many chemical products are functionally more similar to biomass than fuels (Figure 7.17).

Overall, bioproducts have only a tiny presence in the market and much R&D is needed to realize their potential.

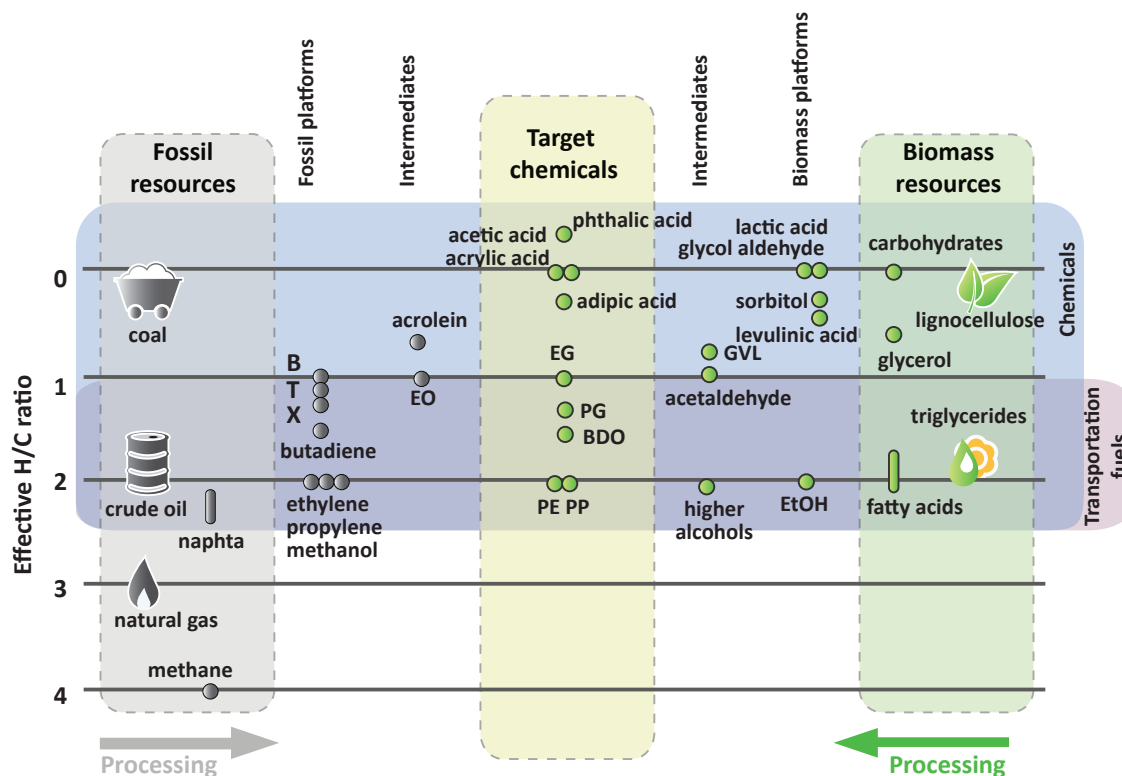
### Biochemical Conversion

Key agents in biochemical conversion are enzymes and microbial consortia. Biochemical conversion route costs have been significantly lowered through an approximately 90% reduction in enzyme cost enabled by development of new enzymes and enzyme cocktails. Development of microorganisms that can more effectively



**Figure 7.17** Producing oxygenated chemicals from olefins involves increasing the molecular weight via oxidation. Hence, the theoretical yield on a weight basis is greater than the weight of the olefin starting material. Biomass is different; because it is highly oxygenated, the molecular weight is usually decreased. On a weight basis, the theoretical yield is less than the weight of the starting sugar or biomass resource. Trying to match the oxidation state (or functional equivalency) can also be advantageous (most oxidized or most functional are presented on the right).

Credit: Vennestrøm, P. N. R., Osmundsen, C. M., Christensen, C. H. and Taarning, E., *Beyond Petrochemicals: The Renewable Chemicals Industry*. *Angewandte Chemie International Edition*, 50, 10502–10509 (2011). Reprinted with permission from John Wiley and Sons.



utilize multiple sugars also contributed to cost reductions. Key breakthroughs in biochemical process steps included the development of more efficient pretreatment processes, improved enzyme production and enzyme load methods, and more robust fermentation organisms that could use sugars in the presence of biomass-derived inhibitors. Many of these were demonstrated between 2001 and 2012.

The limited areas of biobased chemicals manufacturing available today are relatively mature and historically have used traditional sugars such as corn starch or sugar cane for feedstocks. The opportunity for expansion to new pathways should focus on the utilization of cellulosic sugars, lignin, and other renewable feedstocks.

Additional opportunities in biorefineries involve lignin as a feedstock (see Section 7.3.3). The lignin molecular structure itself suggests some applications, including aromatic chemicals and polymers, for applications that could include commodity chemicals currently produced from petroleum, such as benzene, toluene, and xylene, and potentially polymer applications, such as carbon fibers.<sup>63</sup>

In addition to these many applied research activities, important fundamental research is still required. For example, basic research is being conducted by the DOE Office of Science at three centers focusing on transformational breakthroughs (see textbox: *Fundamental Research: Bioenergy Research Centers*).

## Fundamental Research: Bioenergy Research Centers

DOE established three Bioenergy Research Centers (BRCs) in 2007 to accelerate transformational breakthroughs in the basic sciences needed to develop the cost-effective, sustainable, commercial production of cellulosic biofuels on a national scale. Directed fundamental RDD&D approaches focused on creating new energy crops, new methods for deconstructing the lignocellulosic material into chemical building blocks, and new metabolic pathways inserted into microbial hosts to produce ethanol and other hydrocarbon fuels.

The three centers engage national laboratories, academic institutions, and the private sector. The BRCs coordinate research on the entire pathway, from bioenergy crops to biofuel production. The center-scale approach allows technology development specialists to design automated pipelines that streamline workflows and increase research efficiencies. The BRCs offer an unusual opportunity for plant and microbial scientists to work with experts in chemical engineering, computational biology, analytical technology, and many other disciplines to test research ideas from proof-of-concept to field trials. The BRCs also develop intellectual property licensing agreements, partnerships, and targeted collaborative affiliations.

More information can be found at the website for each center:

- **The BioEnergy Science Center** (BESC; <http://bioenergycenter.org/besc/index.cfm>) is focused on the ability of plant cell walls to resist breakdown into their component cellulosic sugars.
- **Great Lakes Bioenergy Research Center** (GLBRC; <https://www.glbrc.org/>) aims to increase the energy density of grasses and nontraditional oil crops by understanding and manipulating the metabolic and genetic circuits that control accumulation of oils in plant tissues.
- **Joint Bioenergy Institute** (JBEI; <http://www.jbei.org/>) is applying synthetic biology to engineering microorganisms that convert sugars into advanced biofuels.

For more information on BRCs, visit <http://genomicscience.energy.gov/centers/BRCs2014HR.pdf>.

### 7.3.5 Fueling Infrastructure for Biofuels

The United States has about 160,000 retail gasoline stations, which distribute 134 billion gallons per year of motor gasoline. Most vehicles on the road today are approved to use E10, which can absorb about 13 billion gallons per year of ethanol. Corn-based ethanol production capacity of 15 billion gallons per year is saturating the gasoline market at E10 levels with the additional ethanol going into E85 and being exported to several countries (primarily Brazil). Ethanol in the form of E85 is available at about 2,600 retail stations.

While E85 has experienced growth over several years, the number of retail stations and the mismatch in the distribution of retail E85 stations and flex-fuel vehicles means slow growth in E85. On the other hand, the aviation sector consumes about 21 billion gallons per year of jet fuel. The United States' top thirty airports use more than 80% of the country's jet fuel. The delivery infrastructure associated with renewable jet fuel is significantly less challenging than the delivery infrastructure required with ethanol.

### 7.3.6 Research and Development Opportunities

Key research opportunities and timing are shown in Table 7.5. Cost competitiveness with conventional fuels and feedstocks is a key metric for each potential fuel production pathway. Satisfactory chemical composition and performance is also essential, and some renewable fuels offer benefits such as higher octane values.

**Table 7.5** Timing for Biomass Research Needs and Priorities

Research priorities	Near term (2–5 years)	Medium term (5–10 years)	Long term (>10 years)
Terrestrial feedstocks	✓	✓	
Algae			✓
Biochemical conversion		✓	✓
Thermochemical conversion	✓	✓	
Bioproducts	✓	✓	✓

Major focus areas for R&D are aviation biofuels, refinery integration, and bioproducts. New conversion processes (biochemical, thermochemical, and hybrid) need to be developed to produce renewable diesel and renewable jet fuel in a cost competitive manner from waste-based lignocellulosic biomass. Conversion processes can produce renewable diesel/jet blend-stocks that meet all relevant specifications and can be blended with conventional jet/diesel. An alternative approach is to produce a biocrude that can be used as a supplementary input (along with crude oil) to a refinery. There are significant compatibility issues associated with this approach, and refinery integration issues must be resolved for biocrudes produced from biomass via pyrolysis. These biocrudes have high oxygen content and are acidic. They need to be stabilized, transported, and minimally upgraded to ensure that they will not damage a petroleum refinery. If acceptable oil can be produced that will be suitable for integration into a refinery, the refinery can operate as usual with a supplemental volume of oil coming from biomass in addition to regular crude oil and use existing delivery infrastructure. The higher-value products (e.g., bio-succinic acid, 1,3-butadiene, animal feed, and fish feed) and use of existing infrastructure can help offset the cost of biofuels production.

Developing a uniform format blended feedstock would yield substantial benefits. One key criterion for building large integrated biorefineries is the biomass draw radius that, with conventional feedstocks, is limited to about seventy-five miles. An advantage of uniform format blended feedstocks would be the ability to transport biomass over longer distances, which would give significant flexibility to large biorefineries. Energy crops need to be developed that have high biomass yield (tons/acre), can be grown in temperate climates, can thrive on marginal soils, and have reduced input requirements such as water and fertilizer. Switchgrass and miscanthus are examples of crops that meet some of these criteria.<sup>64</sup>

Specific areas of interest in biochemical conversion include developing better pretreatment processes, creating lower-cost hydrolytic enzymes, developing new enzymes, limiting contaminants, and creating a tractable lignin stream. New microorganisms are needed that can tolerate high temperatures and highly acidic or basic conditions, that are tolerant of contaminants, and that can produce hydrocarbon-like fuels or precursors that can be easily converted to hydrocarbon fuels. A promising area of research involves extremophiles occurring in the natural environment, such as deep sea ocean thermal vents, thermal geysers, and hot springs. Microorganisms isolated from these environments can tolerate high temperatures and acidic conditions, and can obtain their metabolic energy from sulfur or other inorganic compounds instead of photosynthetically derived carbon dioxide molecules, which increases the range of available energy pathways.

In thermochemical conversion, key focus areas include developing a better understanding of the fundamentals of gasification, pyrolysis, and hydrothermal liquefaction processes, including reaction mechanisms; improving reactor designs; improving the quality of deconstructed intermediates; developing more robust catalysts and catalyst regeneration processes; and developing catalysts with improved specificity. Considerable R&D is

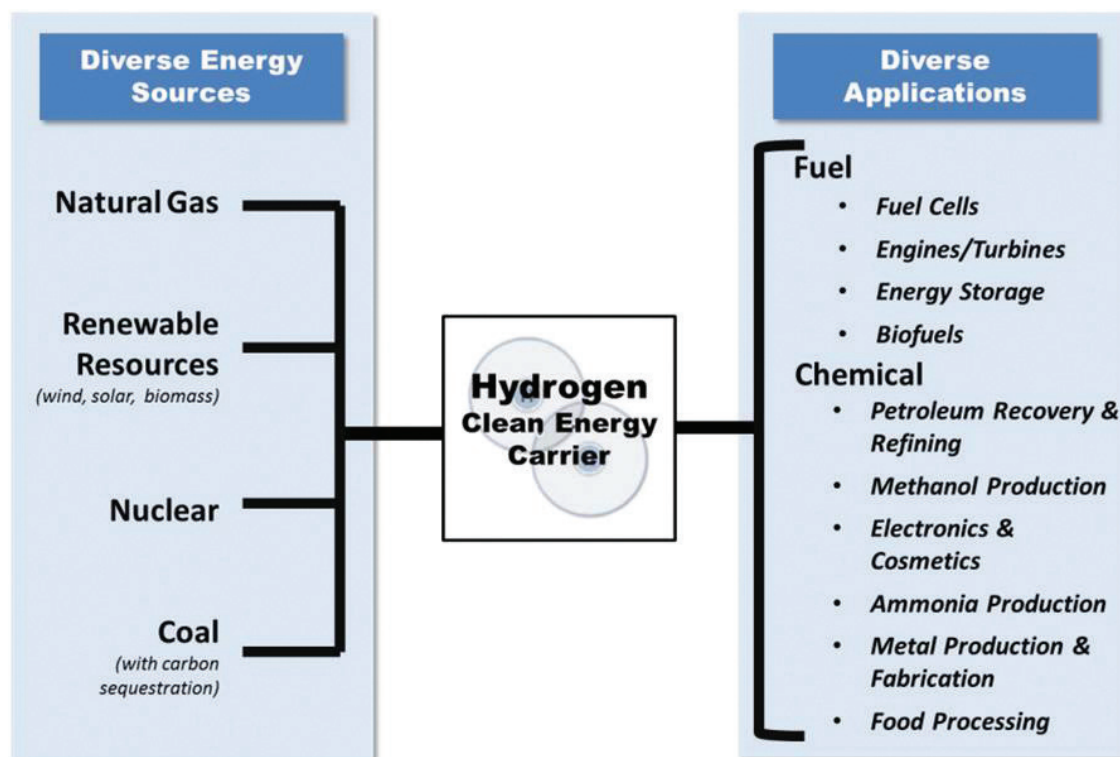
being conducted on catalyst life extension, easier regeneration of catalysts, and development of non-rare-earth catalysts. Discoveries in these areas will reduce the cost of upgrading raw bio-oils and make pyrolysis-derived biofuels cost competitive.<sup>65</sup>

## 7.4 Hydrogen Production and Delivery

As a clean fuel in the energy sector, hydrogen can be used in highly efficient fuel cells for transportation and stationary power applications, in internal combustion engines, and as an energy carrier and storage medium in grid modernization and other applications.<sup>66</sup> In the United States, more than 8,000 fuel cell forklifts and more than 5,000 fuel cell back-up power units have been deployed. In addition, light-duty fuel cell electric vehicles (FCEVs) are now becoming available for lease and for sale.<sup>67</sup> As discussed in Chapter 8, the use of hydrogen with FCEVs in the transportation sector can have a significant impact on reducing GHG emissions, with greater than 80% reductions achievable. Additionally, environmental and energy benefits of hydrogen and fuel cells in energy storage and in power sectors are detailed in Chapters 3 and 4, respectively.

Hydrogen is already a well established chemical commodity in various industrial sectors. Today, hydrogen is most commonly used as an industrial feedstock for refineries and ammonia production. The refinery and fertilizer industries have produced and used hydrogen for decades, and worldwide demand is increasing. The United States' hydrogen consumption, including imports, is more than 10 million tonnes per year, and worldwide consumption is approximately 23 million tonnes per year.<sup>68</sup> The United States currently produces about nine million tonnes annually, mainly from fossil fuels. This production volume is equivalent to a little more than one quadrillion Btus per year (1% of the United States' energy consumption)—enough to power at least 40 million FCEVs. For diverse industrial applications, hydrogen serves as a clean energy carrier that can be produced using a variety of domestic resources, as illustrated in Figure 7.18.

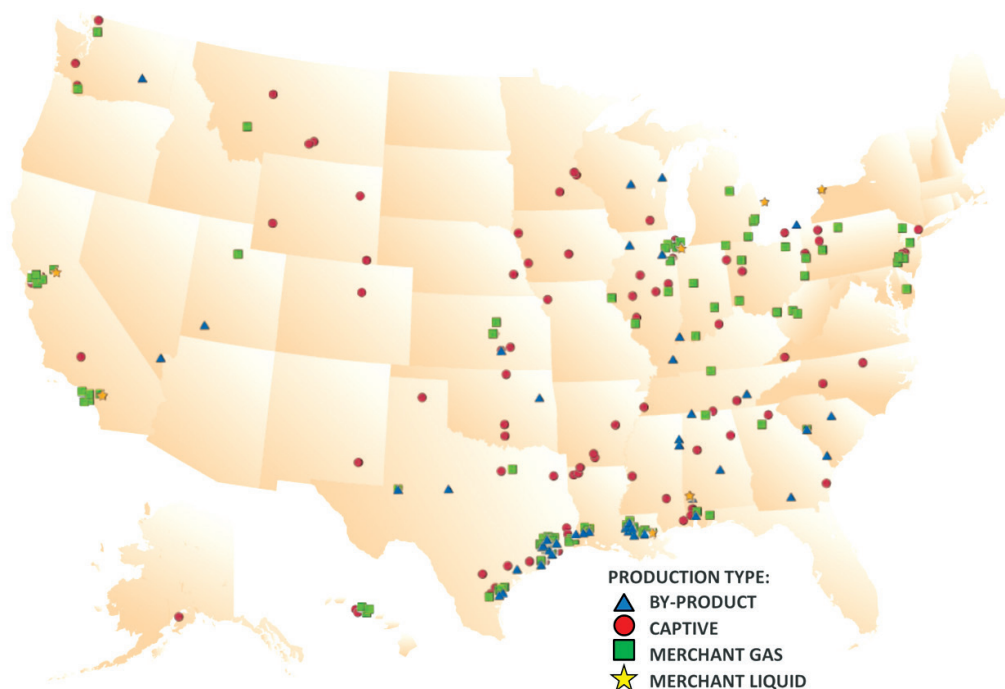
**Figure 7.18** Hydrogen Offers Important Long-Term Value as a Clean Energy Carrier



The majority of the world's hydrogen is currently produced at or near the petroleum refineries and ammonia plants that require it as a chemical feedstock. In North America, hydrogen is most commonly produced using steam methane reforming (SMR) of natural gas. According to the 2012 NPC Future Transportation Fuels Study, *Advancing Technology for America's Transportation Future*,<sup>69</sup> large hydrogen production facilities (>18,000 kg per day) exist in nearly every state in the United States, as illustrated in Figure 7.19. In other countries, such as China and India, coal is the primary feedstock.<sup>70</sup> In all these cases, carbon capture, use, and storage can be used to lower or remove the carbon footprint of the hydrogen produced through the reforming of fossil feedstocks, but this process is yet to be deployed at low cost and at scale.

**Figure 7.19** Existing Centralized Hydrogen Production Facilities in the United States (from the hydrogen chapter of the 2012 NPC Future Transportation Fuels Study)<sup>69</sup>

Credit: National Petroleum Council

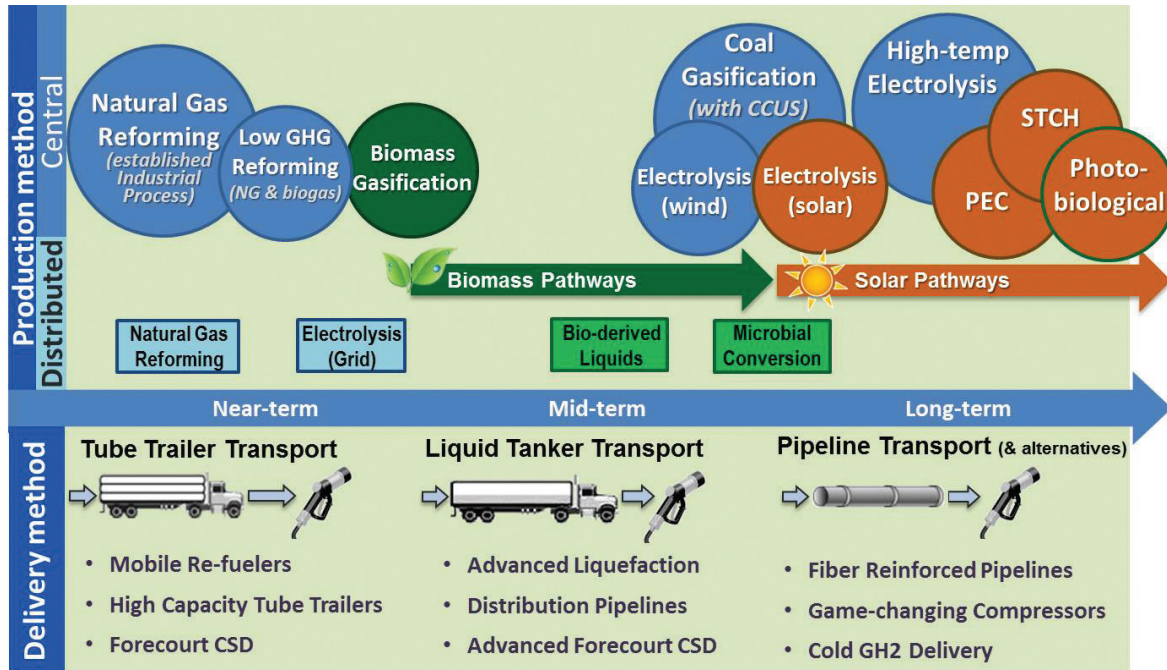


In the near term, the hydrogen production and delivery infrastructure demands of the emerging FCEV market need to be met. Leveraging the synergies between natural gas and hydrogen delivery infrastructure and existing hydrogen production capacity based on natural gas reforming can facilitate meeting these near term needs. In the long term, realizing the environmental and security benefits of hydrogen in the energy sector will require RDD&D of a portfolio of safe, low-cost, low-carbon hydrogen production and delivery methods relying on domestic resources.

### 7.4.1 Hydrogen Production and Delivery Technologies

Hydrogen for transportation fuel can be produced off-site at central facilities and transported to retail fueling stations or produced at the station through a wide variety of pathways represented in Figure 7.20. When hydrogen is produced at the station, it is referred to as distributed or forecourt production. At the retail refueling station, prior to dispensing to the vehicle, hydrogen is compressed to high pressure for onboard storage.<sup>71</sup>

**Figure 7.20** Many possible pathways for production and delivery of hydrogen exist. They vary in scale (semi-central to central production ranges from 50,000 to greater than 500,000 kg per day, while distributed production is up to 1,500 kg per day) and time frame for development, as well as in potential cost and GHG emissions.<sup>78</sup>



## Hydrogen Production

There are many different pathways to produce hydrogen.<sup>72</sup> Numerous low-carbon pathways include reforming of biomass or fossil fuels, such as natural gas and coal, with CCS; and the splitting of water using sustainable and/or renewable energy sources, such as nuclear, wind, solar, geothermal, and hydro-electric power. Most of the hydrogen production technologies fall into three general categories: thermal, electrolytic, and photolytic.

Thermal processes include reforming of natural gas or biofuels, gasification of coal and biomass, and thermochemical processes.<sup>73</sup> Reforming, the most widely deployed technology today, uses high-temperature steam (700°C–1000°C) to produce hydrogen from a methane source. Sources can include natural gas, biogas generated from various biogenic renewable sources, and biomass.<sup>74</sup> Reforming is suitable for both the central and distributed scale. Other thermochemical processes use heat (500°C–2000°C) to drive a series of chemical reactions that produce hydrogen from water. Thermochemical water-splitting processes are best suited for large-scale central production.

Electrolytic processes produce hydrogen and oxygen from water using electricity in an electrolyzer.<sup>75</sup> Electrolyzers can range in size from small, appliance-size equipment well suited for small-scale distributed hydrogen production, to large-scale, central production facilities. Hydrogen produced via electrolysis can result in minimal GHG emissions when low-carbon or zero-carbon electricity is used. Low-temperature electrolyzers are commercially available and are in use at some hydrogen fueling stations. High-temperature electrolysis systems, typically operated at temperatures greater than 750°C with higher electrical efficiency compared with lower temperature electrolyzers, are applicable for use at nuclear reactors and solar thermal facilities, taking advantage of the high-grade heat generated by these technologies.

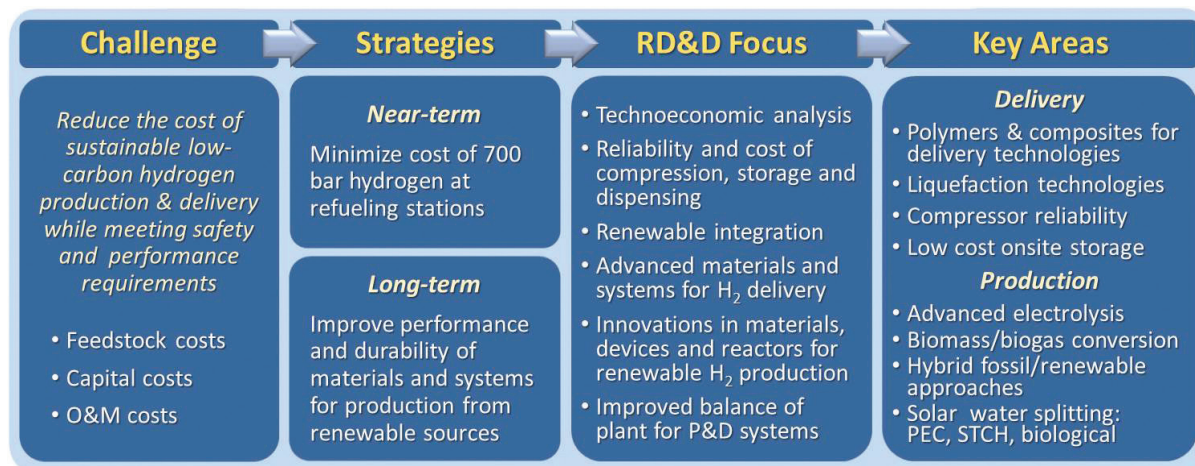
Photolytic processes use the energy in sunlight to separate water into hydrogen and oxygen and can be further classified into two general categories: photoelectrochemical (PEC) and photobiological. In PEC hydrogen production, specialized semiconductor devices harness sunlight to split water.<sup>76</sup> In photobiological production, specialized microorganisms, such as green algae and cyanobacteria, use the energy from sunlight to produce hydrogen.<sup>77</sup> These pathways have long-term potential for sustainable hydrogen production with low environmental impact but are in relatively early stages of R&D.

Alternatively, hydrogen can also be produced through microbial biomass conversion processes, which do not require light, such as fermentation or microbial electrolysis cells. These microbes can consume organic matter like corn stover or wastewater to produce hydrogen. This pathway could be suitable for central hydrogen production or even distributed production for waste stream feedstocks.

### Hydrogen Delivery

As seen in Figure 7.21, a wide range of hydrogen delivery technologies is available to serve existing and emerging markets. Hydrogen delivery includes the infrastructure required to move and store hydrogen from the point of production to the vehicle. This includes transmission, distribution, and refueling station operations. There are three main transmission and distribution pathways: pipeline, tube trailer, and liquid truck. The gaseous hydrogen transmission and distribution pathway is very similar to natural gas distribution today. Pipelines can be made with steel or fiber reinforced polymer pipe and operate at seventy to 100 bar. Gaseous tube trailers carry hydrogen in large, pressurized storage cylinders. These can either be steel cylinders at 180 bar or high-pressure composite cylinders that can carry hydrogen at pressures as high as 500 bar. Typical steel tube trailers can carry approximately 280 kilograms (kg), while the high-pressure tube trailers can carry close to 1,000 kg. Geologic storage is typically used in large-scale gaseous transmission and distribution.

**Figure 7.21** Hydrogen Production and Delivery RDD&D Opportunities and Key Focus Areas<sup>96</sup>



Hydrogen can be distributed as a liquid. During this process, the hydrogen is cooled below -253°C (-423°F) using liquid nitrogen and a series of compression and expansion steps. The cryogenic liquid hydrogen is then stored in large, insulated tanks, loaded into delivery trucks, and transported to the point of use or stored in vacuum-jacketed tanks until it is used. After on-site production or distribution to the point of use, the hydrogen goes through compression, storage, and dispensing at the retail fueling station in order to serve the vehicle market. The hydrogen in light-duty FCEV tanks is pressurized to 700 bar in order to store the approximately five

kg of hydrogen needed to enable a 300-mile vehicle range based on the mile per gallon of gasoline equivalent (mpgge) of today's FCEV within the space available onboard the vehicle.<sup>79,80</sup> The hydrogen is stored at 875–1,000 bar, which requires cooling during the compression process. It must be pre-cooled during dispensing to achieve a three- to five-minute fill time without overheating the storage tank. Therefore, thermal management is a key consideration in cost-effective station design. The heavy-duty vehicle market operates similarly, except that the hydrogen onboard the vehicles is stored at 350 bar rather than 700 bar since larger vehicles are less constrained with respect to space, and lower-pressure vessels provide a cost and weight advantage. This is current practice for transit buses, and it is expected that heavy-duty trucks would operate similarly.

### 7.4.2 Current Status and Accomplishments

Hydrogen production and delivery technologies span a range of development stages. A small number of hydrogen production technologies are currently used commercially or are approaching commercial readiness. These include natural gas and biogas reforming, as well as electrolysis. Other technologies, particularly renewable production pathways such as solar water splitting, require additional RDD&D.

Recent technology advancements have reduced the cost of distributed hydrogen at retail fueling stations to less than \$4.50 per gallon of gasoline equivalent (gge) [assuming high-volume production and widespread deployment].<sup>81</sup> This applies to hydrogen produced by SMR and dispensed at 700 bar, and is valid over a wide range of natural gas prices. At the lower end of the range of natural gas prices, hydrogen cost drops below the 2020 target of less than \$4 per gge<sup>82</sup> for FCEV cost-competitiveness with other vehicle technologies.<sup>83</sup> For early markets, the interim target is less than \$7 per gge.<sup>84</sup> CCS would reduce the associated GHG emissions with the mature SMR pathway. Ongoing demonstration projects (e.g., a DOE-sponsored project at a hydrogen production facility in Port Arthur, Texas) that capture and store CO<sub>2</sub> from SMR plants are aimed at demonstrating the viability of this CCS approach, but widespread commercial deployment will depend on improvements in the benefit-cost ratio through further RDD&D. In the near term, low-carbon hydrogen can also be produced through reforming biogas (i.e., renewable natural gas), either through modified SMR, or using high temperature fuel cells that can simultaneously generate power, heat, and hydrogen (typically called combined heat, hydrogen, and power, or CHHP) with a lower carbon footprint than natural gas SMR.<sup>85</sup>

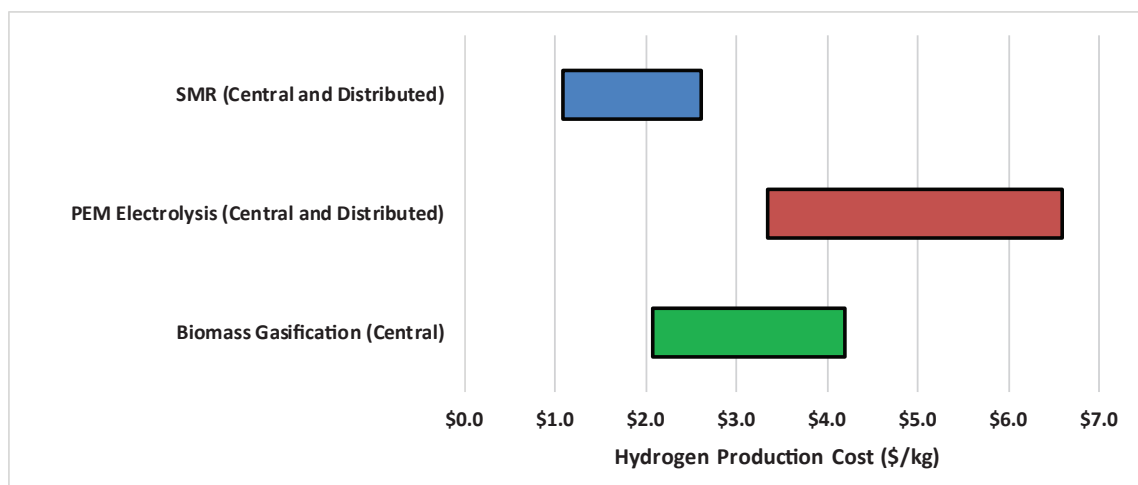
Electrolysis is also a commercial technology typically used today for small- to mid-scale hydrogen production, but scalable to larger megawatt-scale systems. There is growing interest, particularly in locations where emissions standards are in place (e.g., Europe, California), for pairing water electrolysis with “green” electricity as a way to use renewable electricity that otherwise would be curtailed during periods of low demand. Biomass gasification is a promising near-term technology that has not yet been commercialized at scale. Figure 7.22 summarizes the current range of production costs.<sup>86</sup> Through RDD&D in recent years, production costs have dropped from nearly \$6.50 per kg in 2006 to approximately \$5 per kg in 2013 for electrolysis, and from nearly \$3 per kg in 2006 to about \$2.50 per kg in 2013 for biomass gasification (at high volume).

Current industrial production capacity could potentially provide sufficient hydrogen fuel for early-market FCEV deployment.<sup>87</sup> Going forward, demand growth would require increased capacity, with a priority on hydrogen production from renewable and/or low-carbon pathways. To meet this demand, a portfolio of low-carbon hydrogen production pathways would be needed, including emerging options such as microbial biomass conversion, photobiological production, and solar-based thermo- and photoelectrochemical water-splitting, which require additional RDD&D to reach commercial readiness.

In all hydrogen production pathways, high conversion efficiencies are critical to reducing the hydrogen cost. To date, feedstock-to-hydrogen energy conversion efficiencies exceeding 70% have been demonstrated for SMR, while ~46% has been achieved in biomass gasification.<sup>89</sup> Hydrogen can also be produced by coupling



**Figure 7.22** Current Range of Hydrogen Production Costs (undispensed and untaxed, reported in \$/kg including feedstock and capital cost variability assuming high volume production and widespread commercialization)<sup>88</sup>



natural gas combined cycle power plants with water electrolysis systems. Conversion efficiencies of ~32% have been achieved with this approach using commercial low-temperature electrolyzers (including 67% electric-to-hydrogen electrolyzer efficiency, and 48% efficiency for the upstream natural gas combined cycle power plant), with efficiencies greater than 50% achievable using advanced high-temperature electrolyzers operating above 800°C.<sup>90</sup> Higher conversion efficiency reduces feedstock requirements and lowers cost. Continued RDD&D focused on improving efficiencies can reduce hydrogen costs in all the near- to longer-term technologies.

In conjunction with the current industrial production capacity to support early-market FCEV deployments, significant hydrogen delivery infrastructure is in place to serve the industrial market. The United States has more than 1,500 miles of hydrogen pipelines, primarily along the Gulf Coast.<sup>91</sup> The Praxair salt dome cavern on the Gulf Coast is one of the largest hydrogen storage systems in the world, with 1.4 billion cubic feet of working storage. California is the first state making significant investments in hydrogen infrastructure for the light-duty vehicle market, working to achieve a target of one hundred hydrogen refueling stations by 2020.<sup>92</sup> There will be twenty-eight stations open by the end of 2015 with twenty-three more stations planned to open in 2016.<sup>93, 94</sup>

High-pressure gaseous tube trailer delivery is the lowest-cost delivery method to serve the near-term vehicle market (Table 7.6). This is attributable to the decrease in compression required at the station when the gas is delivered at high pressure. Relatively small amounts of gaseous hydrogen can be transported short distances by high-pressure (up to 500 bar) tube trailers. A modern high-pressure tube trailer is capable of transporting nearly 1,000 kg of hydrogen. Gaseous transmission and distribution through pipelines remains the lowest-cost delivery option for large volumes of hydrogen. The high initial capital associated with this pathway constitutes a major barrier to the construction of new hydrogen pipelines.

The liquid hydrogen pathway is a well-developed and competitive method of providing hydrogen for high-demand applications that are beyond the reach of hydrogen pipeline supplies. It is more economical than gaseous trucking for high market demands (greater than 700 kg per day) and has longer delivery distances because a liquid tanker truck with a capacity of approximately 4,000 kg can transport more than four times the capacity of a 500-bar gaseous tube trailer. The nine existing liquefaction plants in North America vary in production size from 5,400-62,000 kg of hydrogen per day. Table 7.4 shows the current costs for a range of hydrogen delivery pathways at high volume.

**Table 7.6** Hydrogen Delivery Cost as a Function of Dispensed Gas Pressure and Delivery Pathway as Reported from the Hydrogen Delivery Scenario Analysis Model (to the nearest 0.05)<sup>95</sup>

Dispensing pathways	350 bar	700 bar
	Delivery costs (\$/kg hydrogen delivered and dispensed)	
Pipeline	4.45	4.85
Pipeline—tube trailer	3.15	3.20
Tube trailer	3.00	3.30
Pipeline—liquid tanker	N/A	3.75
Liquid tanker	N/A	3.25

### 7.4.3 RDD&D Opportunities

Cost reduction of at-scale technologies remains the key challenge in the production and delivery of hydrogen, particularly from low-carbon sources for use in fuel cell electric vehicles. The critical barriers and strategies for reducing the cost of hydrogen production and delivery are shown in Figure 7.23. Since high-volume market penetration is an essential factor for any cost reduction, lowering the cost of hydrogen for 700 bar refueling to accelerate the introduction of FCEVs into the market place is an important near-term requirement. Identifying RDD&D priorities will rely on techno-economic analysis and modeling to identify refueling station equipment and processes that can reduce refueling cost the most, along with cost mitigation approaches based on technology improvements. Broader RDD&D opportunities addressing longer-term needs include lowering the cost of hydrogen from renewable and low-carbon sources through process and materials development.

The thermal production processes such as bioderived liquid reforming, and coal and biomass gasification could achieve reduced capital cost through improved catalysts and low-cost separation and purification technologies. Electrolysis systems are another near-term hydrogen production pathway that requires additional research to reduce costs and improve efficiency, in particular. Currently, feedstock cost is the most significant contributor to the hydrogen cost from this pathway. As a result, it is important to focus on improving the process efficiency while reducing the capital cost. Development of load-following capability would provide more economical system operation during times of low demand. The cost of low-temperature electrolysis could be up to 10% lower if efficiency increased 10%, from 67% production efficiency to 74%. Chapter 4 discusses coal gasification cost and performance.

The costs of all emerging production pathways need to be significantly reduced for hydrogen to become a major contributor to transportation fuel. As material costs and performance improvements are needed for most of these pathways, promising areas of RDD&D with impacts on multiple pathways are high throughput/combinatorial approaches to enable rapid identification and development of promising materials systems as appropriate. PEC production requires RDD&D to develop materials with the appropriate band gap to both absorb sunlight and electrolyze water in a single device, while solar thermochemical hydrogen production pathways require identification and development of efficient and durable materials to design a cost-effective reactor system. Photobiological approaches require fundamental research in a number of areas such as direct water splitting using microalgae or cyanobacteria, and optimization of energy flows and electron flux. Microbial biomass conversion methods such as fermentation require research to improve hydrogen production yields and rates.

A high-temperature advanced nuclear reactor coupled with one of the high-temperature technologies (thermochemical cycles, electrolytic, and hybrid thermochemical/electrolytic) could achieve a thermal-to-hydrogen conversion efficiency of 45% to 55%. However, this technology is not yet ready for commercialization. There are challenges regarding the high temperature and the design of corrosion-resistant materials. To address these, system design development is needed to study the hydrogen plant and its relationship to the reactor, including configuration options and operating conditions, system isolation issues, and intermediate heat transfer loop design. Chapter 4 on power technologies contains a discussion on related nuclear energy RDD&D.

Hydrogen's low volumetric density poses a challenge with respect to the costs of storage and delivery, necessitating further RDD&D to improve the efficiency, cost, and reliability of compression, storage, and delivery technologies for 700-bar refueling. This can be achieved through researching new materials for high-pressure dynamic and static seals, developing new compression technologies such as linear motor, metal hydride, and thermal compressors, and demonstrating alternative refueling and control algorithms to lessen the burden on the station. Longer-term priorities in delivery include developing advanced technologies for liquefaction, geologic storage, and pipelines and pipeline compressors. Issues such as hydrogen embrittlement and safety clearly must be addressed; addressing these challenges requires continued materials compatibility RDD&D. With successful technology development, hydrogen delivery costs could be reduced by more than 50% (2020 target is less than \$2 per gge<sup>97</sup> versus today's cost of \$3–\$5/gge) that would enable economic competitiveness of hydrogen FCEVs with gasoline ICEs.

Figure 7.23 summarizes the near-, medium-, and long-term research areas. For both production and delivery technology pathways, it is necessary to continue developing and testing innovative materials, components, and systems.

**Figure 7.23** RDD&D areas and time frames for Hydrogen Production and Delivery

Research opportunities	Near term	Medium term	Long term
	(2–5 years)	(5–10 years)	(>10 years)
Compression and storage at fueling stations	■		
Distributed scale liquefaction and pipeline technologies	■		
High-pressure tube trailers	■		
Bioliqids reforming, biomass and coal gasification	■		
Sustainable, low-carbon hydrogen (e.g., biological, thermochemical, photo-electrochemical)	■		

The major challenge is to reduce the cost of producing and delivering hydrogen from renewable and low-carbon sources using a portfolio of technologies that are scalable, and that meet industrial performance and safety requirements. To reduce costs, continued RDD&D is needed to improve materials, systems, and scaled technologies for diverse hydrogen production and delivery options. Near-term cost reductions can be achieved by leveraging the synergies between natural gas and hydrogen delivery infrastructure and the existing hydrogen production capacity. This is important to support the early market deployment of FCEVs, and to promote development and deployment of the hydrogen production and delivery technologies and infrastructure needed to sustain market growth. The longer-term priority is to transition to the sustainable and low-carbon options for hydrogen production and delivery to fuel growing markets in the transportation, stationary heat and power, and energy storage sectors.

## 7.5 Other Alternative Transportation Fuels

Several alternatives to the three major classes of fuel discussed above (oil and gas, biofuels, and hydrogen) that have been and continue to be explored for potential environmental and security benefits. Most of these options emit fewer GHGs over production and use cycles and fewer criteria pollutants at the point of use. All can be produced from abundant domestic resources within the United States. To date, they all have some barriers to widespread deployment in the United States. Some of these barriers are inherent in the fuels (e.g. methanol's toxicity) while others require additional fundamental basic research. The DOE Office of Science actively supports the development of several transformational technologies through activities such as the Joint Center for Artificial Photosynthesis (see textbox: *Joint Center for Artificial Photosynthesis*).

### Joint Center for Artificial Photosynthesis

#### Fuels from Sunlight Energy Innovation Hub: Goals, Challenges, and Progress

Increased solar energy utilization is helping the United States meet growing energy demands. The ability to generate commercial fuels directly from sunlight holds great promise as a new innovation in energy production, potentially enabling fossil fuels to be replaced with solar fuels. Through the process of photosynthesis, plants and some microbes convert sunlight into energy-rich chemical fuels using the abundant feedstocks of water and carbon dioxide. It would be enormously beneficial to develop an artificial system capable of generating fuels directly from sunlight using just water and carbon dioxide in a manner analogous to the natural photosynthetic system. Despite decades of basic research advances, however, it is not yet possible to produce solar fuel generation systems with the required efficiency, scalability, and sustainability to be economically viable.

In 2010, DOE established the Fuels from Sunlight Energy Innovation Hub, the Joint Center for Artificial Photosynthesis (JCAP), which is focused on transformative advances needed to enable artificial photosynthesis. The goal of this multidisciplinary, multi-investigator, and multi-institutional effort is demonstrating systems that convert sunlight, water, and carbon dioxide into a range of commercially useful fuels. JCAP's overall approach is to develop robust concepts and designs for complete solar-fuels generators, define the essential assemblies of active components for the generators, and then discover or adapt materials needed to fabricate the assemblies.

More information on JCAP can be found at this website: <http://solarfuelshub.org>

## 7.5.1 Natural Gas as a Transportation Fuel

Natural gas fueled vehicles are a well-established, mature industry. Millions of natural gas vehicles are on the road worldwide today, yet, in the United States, only a small fraction of cars and trucks use natural gas. There are three principal ways in which natural gas is employed for vehicles: 1) as compressed natural gas (CNG), 2) as liquefied natural gas (LNG), or 3) converted via chemical processes into a liquid fuel. Historical barriers to expanded use of natural gas in vehicles include the lack of an infrastructure for distribution and vehicle fueling, the significant additional cost of vehicle hardware, such as natural gas fuel tanks, and uncertainty concerning natural gas prices over the long term.

### LNG for Long-Haul Trucks

Displacing diesel fuel with LNG in Class 8 long-haul trucks (18-wheelers travelling long routes) is of increasing interest within private industry. The lower cost of natural gas has the potential for significant fuel cost savings. Developing a fueling infrastructure for LNG long-haul trucks presents a significant challenge but is one the market is beginning to pursue. With a continued positive business case, private industry is beginning to make the investments needed for such an infrastructure.

### CNG for Fleets

Widespread adoption of CNG centralized fleets of light- and medium-duty vehicles is primarily hindered by the higher initial vehicle purchase price and large up-front infrastructure costs. Municipal buses, delivery vehicles, and other fleet vehicles have turned to natural gas primarily for air quality concerns, not because of economic advantages. Unlike long-haul trucks, such fleets do not travel as many miles or use as much fuel, which makes the payback period much longer. For medium-duty vehicles, the incremental cost typically takes twelve to fifteen years to recover out of a twenty- to thirty-year lifespan. Light-duty vehicles may never recover the initial incremental cost premium because of their shorter service life. There are also significant infrastructure costs that must be accounted for. A CNG station is required (\$400,000–\$1,000,000), and fleet maintenance facilities must be updated at additional cost to handle gaseous fuels.

### CNG for Private Vehicles

In the light-duty personal vehicle market, lack of a ubiquitous fueling infrastructure and high vehicle cost (relative to gasoline-fueled vehicles) combine to present an overwhelming challenge to mass market consumer acceptance. Today, there are roughly 160,000 gasoline service stations in the United States. Creating a similar nationwide infrastructure for natural gas refueling at even a fraction of those service stations would be prohibitively expensive (\$100 billion or more). Range limitations with natural gas represent an additional hurdle to widespread adoption.

### Chemical Conversion of Natural Gas to Liquid Fuels

Natural gas can be converted into liquid fuels using two main chemical processes, but neither is commercially available at scale in the United States. The first approach employs a widely used technology known as “Fischer-Tropsch” to produce a number of products, including diesel fuel. Additional discussions on this process can be found later in the section dealing with coal to liquids. Another approach is used to produce methanol from natural gas. Methanol is already produced from natural gas in very large quantities for industrial purposes, at costs roughly equivalent to gasoline. It could be used as a blend, much like ethanol, or converted to gasoline through a commercially available process.

## LNG/CNG Distribution

CNG stations receive fuel via a local utility line at a pressure lower than that used for vehicle fueling. The station compresses the gas to a higher pressure for vehicle fueling. Described below are the three types of CNG stations: fast-fill, time-fill, and combination-fill. The main structural differences are the amount of storage capacity, size of the compressor(s), and dispensing rate.

- **Fast-fill:** The compressor and storage capacity for fast-fill stations are designed such that drivers experience fill times similar to those for gasoline or diesel fueling stations.
- **Time-fill:** This equipment fills CNG vehicles over a period of hours and is typically used by fleets with vehicles that fuel at a central location each night. The time it takes to fuel a vehicle depends on the number of vehicles, the amount of fuel required, and the throughput of the compressor. Vehicles are unattended during the fueling process, which can take minutes to hours.
- **Combination-fill:** At combination-fill stations, users have the ability to time-fill or fast-fill vehicles on demand. Many fleets use the convenience of time-fill as the primary method of fueling, with fast-fill available as needed.

## Conclusion

While sales of natural gas-powered cars and trucks are small, the technology to build such vehicles is well known. The primary barriers to expanded use of natural gas in vehicles have been concerns about the future price of natural gas and the absence of an infrastructure to deliver the gas. Centrally fueled fleet vehicles (such as medium-duty trucks) offer the most mature market for using natural gas directly in the transportation sector, but this market represents a small percentage of our on-road fuel consumption. It would be significantly more complex to create an infrastructure that would allow a significant fraction of cars to operate on natural gas. In addition, there are climate concerns about methane and carbon emissions.

Technology improvements that could encourage expanded use of natural gas include the following:

- Cheaper onboard fuel storage and home-fueling compressors
- Broader range of available engine options for medium- and heavy-duty trucks
- Improved techniques for conversion of natural gas to conventional fuel (gas-to-liquids)

### 7.5.2 Ammonia and Carbon-Free Energy Carriers

Controlling carbon emissions from fossil energy resources will require systems for CCS. In the transportation fuels space, fossil resources can be converted to carbon-free energy carriers at a central location where CCS can be used, and then fuel can be distributed for use. The most common forms of such energy carriers currently recognized are electricity (discussed in Chapter 6) and hydrogen (discussed in Chapter 8).

An important question is what other carbon-free energy carriers might be used. One proposed option is ammonia. Along with hydrogen, ammonia has no carbon emission when combusted because it doesn't contain carbon. Existing infrastructure and current transportation energy systems are compatible with ammonia with relatively modest changes. Ammonia also has a high octane rating (about 120 versus gasoline at 86–93) and can be used in high compression engines. However, it has a relatively low energy density per gallon—about half of gasoline—so its fuel mileage is about half of gasoline's mileage. Issues also remain with toxicity, especially from ammonia vapor.

### 7.5.3 Coal (Biomass and Hybrid Systems) to Liquids

Coal-to-liquids (CTL) account for a small share of world liquids production but is expected to increase, assuming petroleum costs rise in the future. In particular, CTL accounted for the equivalent of 0.19 million

barrels per day in 2012. EIA<sup>98</sup> projects that number to grow to 1.12 million barrels per day by 2040. Nearly all of this increase is expected in China.

Historically, the CTL process has been used to convert coal into a substitute for liquid fuels in countries with a large coal resource and limited petroleum supplies. CTL includes both direct coal liquefaction technologies, and coal gasification combined with Fischer-Tropsch synthesis to produce liquid fuels. Following the oil crisis of the 1970s, significant coal liquefaction R&D was undertaken in Australia, Europe, Japan, and the United States, but much of this R&D was put on hold as oil prices stabilized from the mid-1980s through the 1990s. Owing to higher oil prices following that period, interest increased in CTL and biomass to liquids, including coprocessing coal and biomass (CBTL). China, in particular, has aggressively pursued conversion of CTL. Since 2005, China has developed three demonstration level CTL plants producing 4,500 barrels per day of products. Their largest CTL plant—producing 100,000 barrels per day—will be completed in 2016, and six more mega projects are scheduled. The most ambitious project will be the largest CTL plant in the world, producing four million tons per year.

Ongoing interest in reducing GHG emissions from energy production has resulted in increased effort to reduce GHGs from CTL production, since conversion results in GHG emissions significantly higher than conventional petroleum. Approaches for reducing GHGs include the following:

- Capturing and geologically storing CO<sub>2</sub> produced during the CTL process. This is attractive because 91% of CO<sub>2</sub> produced in the coal conversion process is in a concentrated stream that can be easily captured.
- Coprocessing coal and biomass to produce liquid fuels. Adding CCS to this CBTL process dramatically reduces GHGs because biomass conversion results in low GHGs, and when CCS is introduced, the biomass component becomes carbon negative.

A 2009 study<sup>99</sup> found that for a commercial process that converts coal into diesel fuel, coupling the process with carbon sequestration is relatively inexpensive, adding only seven cents per gallon. Furthermore, this small investment reduces the GHG emissions dramatically, from 147% above the petroleum-derived diesel baseline to 5% below it. The study looked at one technology enhancement (addition of an auto thermal reactor) that further reduced GHGs, but it did not consider ongoing R&D that will make the gasification process even more efficient and cost-effective.

Systems combining various inputs of biomass and coal, converting them at a central facility to liquid fuels and electric power, and using CCS on CO<sub>2</sub> released at that facility have been analyzed and these studies variously identify net positive, neutral, or negative carbon emissions.<sup>100</sup> The differences between cases depends on the balances of inputs and outputs. The fraction of input energy from biomass is a key factor as biomass draws CO<sub>2</sub> from the atmosphere during growth; then, when the biomass is converted to fuels and power, using CCS can enable a net drawdown of CO<sub>2</sub> from the atmosphere for that portion. This is balanced against the portion used as fuel for which CCS is not practical. Biomass feedstock costs increase with the scale of the conversion facility due to the large required collection areas and logistic costs, but the reduction in energy production costs for larger facilities can more than compensate for this over a wide range of cases, but is ultimately constrained by truck traffic congestion at the facility.<sup>101</sup> Research to reduce costs for smaller facilities and to improve biomass productivity and logistics could help address these factors.

#### 7.5.4 Fuel Methanol and Dimethyl Ether

Methanol (CH<sub>3</sub>OH), also known as wood alcohol, is considered an alternative fuel under the Energy Policy Act of 1992. Methanol was marketed in the 1990s as an alternative fuel for compatible vehicles. At its peak, nearly six million gasoline gallon equivalents of 100% methanol and 85% methanol/15% gasoline blends were used annually in alternative fuel vehicles in the United States. As an engine fuel, methanol has chemical and physical

fuel properties similar to ethanol. Methanol use in vehicles has declined dramatically since the early 1990s, and automakers no longer manufacture methanol vehicles in the United States, although it is still a popular fuel worldwide. It is generally produced by steam-reforming natural gas to create a synthesis gas. Feeding this synthesis gas into a reactor with a catalyst produces methanol and water vapor. Various feedstocks can produce methanol, but natural gas is currently the most economical in North America (in China, coal is preferred).

Methanol can be an alternative to conventional transportation fuels. The benefits of methanol include the following:

- **Lower production costs:** Methanol is inexpensive to produce relative to other alternative fuels.
- **Improved safety:** Methanol has a lower risk of flammability compared to gasoline.
- **Increased energy security:** Methanol can be manufactured from a variety of carbon-based feedstocks, such as natural gas and coal. Its use could also help reduce the United States' dependence on imported petroleum.

Dimethyl ether (DME) represents an alternative to CNG and LNG as a natural gas-derived transportation fuel. It can be synthesized from methanol via dehydration. In contrast to CNG, which requires onboard storage at high pressures (250 bar/3600 psi), and LNG, which requires low temperatures (-162°C), DME behaves like propane in that it is liquid at ambient temperatures and moderate pressures. Its combustion characteristics are well suited for use in diesel applications such as trucks, buses, and construction equipment. As a compression ignition fuel, DME is considered “clean burning” in that it is less likely to produce particulate (soot) emissions than diesel or bunker fuel. DME is also nontoxic and is not itself a GHG. DME has lower energy density (18.9 megajoules per liter), however, than diesel (37.3 megajoules per liter). Combustion studies and engine demonstrations of DME as a compression ignition fuel were performed throughout the 1990s, but further activity was halted when the price of natural gas increased nearly tenfold in 2000. Three important developments offer new research opportunities for DME: 1) the discovery of large domestic supplies of natural gas and subsequent price stabilization, 2) recent developments in advanced combustion regimes for engines, and 3) process developments to convert natural gas to DME in retail outlet quantities. By making and dispensing DME on-site, distribution through the existing natural gas infrastructure could provide a pathway to DME-fueled transportation with minimal infrastructure upgrades. Of course, the combustion products of DME include CO<sub>2</sub>, which must be controlled to address climate change.

## 7.6 Conclusion

Each fuel has strengths and shortcomings, and the fuel system must meet several challenging needs: economic prosperity requires low-cost fuels; energy security requires stable, abundant domestic resources; and meeting environmental goals requires reduction of greenhouse gas emissions and other externalities. This chapter explores options to address each of these challenges in oil and gas, in bioenergy for fuels, and in hydrogen production and distribution, as well as for other fuel options.

### Oil and Gas

Until recently, domestic oil and natural gas production was in decline, but because of technology advances in hydraulic fracturing, among others, the United States is now the world's largest producer of these fuels. While oil and gas are low cost, have good economics, are abundant, and support national security, they have a poor carbon footprint and other environmental challenges.

### Bioenergy for Fuels

Bioenergy from a variety of feedstocks can be converted to a wide variety of products and liquid fuels and offer the potential to significantly reduce the GHG emissions associated with liquid fuel use. While ethanol



from corn is an established industry, advanced pathways to use cellulosic, lignin, and waste inputs are just now beginning to enter the market but could scale up domestic low-carbon fuel production if key technology cost, scalability, and land use challenges can be met.

## Hydrogen

Hydrogen is an energy carrier that can be produced from a variety of energy resources. It is produced in large quantities today from natural gas. Technology options such as electrolysis from low-carbon electricity, direct reforming of fossil fuels with CCS, or production from biomass (possibly with CCS to achieve negative carbon emissions) can produce hydrogen for fuel with a very low carbon footprint from domestically available energy resources. Challenges include technology costs of these low-carbon resources, as well as distribution and fueling infrastructure.

## Future Prospects

The QTR identifies many opportunities for RDD&D to support the future of fuels in the United States. After several decades of generally flat (gas) or declining (oil) production, production of shale gas and oil has sharply increased in the United States in the past half-dozen years. Commercial production of cellulosic biomass fuels began in 2014 after many years of research and development. Public-private partnerships are now beginning to supply hydrogen for the new consumer FCEV market. Each of these fuels will pose tradeoffs—cost, performance, infrastructure, security, climate impact, and others—across different time frames. A strong understanding of the technological options in the fuels sector through the QTR can support an informed R&D strategy going forward (Table 7.7).

**Table 7.7** Summary of RDD&D Opportunities

Area	RDD&D opportunities
Oil and gas	<ul style="list-style-type: none"> <li>■ Minimizing the safety and environmental impacts of unconventional oil and gas development: protecting groundwater, increasing water availability, and protecting air quality</li> <li>■ Mitigating risk of offshore oil spills</li> <li>■ Reducing methane leaks associated with pipelines and compressors</li> <li>■ Understanding induced seismicity</li> <li>■ Develop understanding required for commercial production of natural gas from natural hydrate deposits</li> <li>■ Controlling carbon emissions with CCS where used at scale</li> </ul>
Bioenergy for fuels	<ul style="list-style-type: none"> <li>■ Reducing costs of feedstock production and improving logistics and conversion</li> <li>■ Producing and managing a consistent, aerobically stable suite of lignocellulosic feedstocks</li> <li>■ Improving enzymes and microorganisms for biochemical pathways and improving catalysts and processes for thermochemical pathways</li> <li>■ Producing high-value bioproducts and biobased inputs to chemicals</li> </ul>
Hydrogen	<ul style="list-style-type: none"> <li>■ Reducing costs of converting the end-to-end fuels infrastructure to accommodate hydrogen</li> <li>■ Reducing costs of hydrogen production from low- or zero-carbon resources</li> <li>■ Exploring new materials to improve efficiencies, performance, durability, cost, and safety</li> </ul>

## Chapter 7: Advancing Systems and Technologies to Produce Cleaner Fuels

# Technology Assessments

- 7A** Bioenergy Conversion
- 7B** Biomass Feedstocks and Logistics
- 7C** Gas Hydrates Research and Development
- 7D** Hydrogen Production and Delivery
- 7E** Natural Gas Delivery Infrastructure
- 7F** Offshore Safety and Spill Reduction
- 7G** Unconventional Oil and Gas

[See online version.]

## Supplemental Information

- Oil and Gas Technologies
- Subsurface Science and Technology

[See online version.]

### Endnotes

- <sup>1</sup> Energy Information Administration. “Annual Energy Outlook.” 2015; Table A2. Note: For industry and buildings, most of the energy not directly supplied by fuels is from electricity, for which upstream electricity-related generation and other losses are included in the total for energy use by the sector and in the calculation for the share of energy that direct fuel use provides.
- <sup>2</sup> Energy Information Administration, “Annual Energy Outlook.” 2015; Table 37.
- <sup>3</sup> As of June 24, 2015, the U.S. Department of Energy has granted final approval to export LNG to non-Federal Transit Administration countries from the following LNG Terminals: Sabine Pass LNG Terminal (2.2 Bcf/d), Freeport LNG Terminal (1.8 Bcf/d), Cameron LNG Terminal (1.7 Bcf/d), Dominion Cove Point (0.77 Bcf/d), Corpus Christi LNG Terminal (2.1 Bcf/d).
- <sup>4</sup> Energy Information Administration. “Annual Energy Outlook.” 2015.
- <sup>5</sup> National Research Council, Council on Benefits of DOE R&D on Energy Efficiency and Fossil Energy, Board on Energy and Environmental Systems, Division on Engineering and Physical Sciences. “Energy Research at DOE: Was it Worth It?,” 2001. *Energy Efficiency and Fossil Energy Research, 1978 to 2000*. 2001, p. 201.
- <sup>6</sup> Energy Information Administration. “Annual Energy Outlook.” 2015.
- <sup>7</sup> In Re: Oil Spill by the Oil Rig “Deepwater Horizon” in the Gulf of Mexico, on April 20, 2010, No. 10-2771 and No. 10-4536, Findings of Fact and Conclusions of Law, Phase Two Trial at 43-44 (E.D.L.A. Jan 15, 2015). Available at: <http://www2.epa.gov/sites/production/files/2015-01/documents/phase2ruling.pdf>.
- <sup>8</sup> National Petroleum Council. “Prudent Development: Realizing the Potential of North America’s Abundant Natural Gas and Oil Resources.” 2011, Table 1-3 Natural Gas Resource Base, p. 72.
- <sup>9</sup> Ibid. Table 1-1 Natural Gas Resource Base, p. 65.

- <sup>10</sup> Energy Information Administration. “Today in Energy, September 11, 2012. Pad Drilling and Rig Mobility Lead to More Efficient Drilling.” Available at: <http://www.eia.gov/todayinenergy/detail.cfm?id=7910>.
- <sup>11</sup> Ibid.
- <sup>12</sup> Society of Petroleum Engineers. PetroWiki. Available at: [http://petrowiki.org/Directional\\_deviation\\_tools](http://petrowiki.org/Directional_deviation_tools).
- <sup>13</sup> U.S. Department of Energy, Office of Fossil Energy. “Environmental Benefits of Advanced Oil and Gas Exploration and Production Technology.” Available at: <http://www.netl.doe.gov/kmd/cds/disk25/oilandgas.pdf>.
- <sup>14</sup> U.S. Department of Energy. “Modern Shale Gas Development in the United States: A Primer.” April 2009, p. ES-3.
- <sup>15</sup> U.S. Environmental Protection Agency. “Technical Workshops for the Hydraulic Fracturing, March 2011, Novel and Emerging Technologies for Produced Water Treatment.” Available at: [http://www2.epa.gov/sites/production/files/documents/18\\_Xu\\_-\\_Treatment\\_Technologies\\_508.pdf](http://www2.epa.gov/sites/production/files/documents/18_Xu_-_Treatment_Technologies_508.pdf).
- <sup>16</sup> National Commission on the BP Deepwater Horizon Oil Spill and Offshore Drilling. Report to the President. “Deepwater: the Gulf Oil Disaster and the Future of Offshore Drilling.” Chapter 4.
- <sup>17</sup> Society of Petroleum Engineers. PetroWiki. “Expandable Tubulars.” Available at: [http://petrowiki.org/Expandable\\_tubulars](http://petrowiki.org/Expandable_tubulars).
- <sup>18</sup> U.S. Department of Energy, National Energy Technology Laboratory. “Partners Progress.” March 1999, p. 4. Available at: <http://www.netl.doe.gov/kmd/cds/disk23/N-Newsletters/National%20Lab%20Partnership%20Newsletters%5C1999-03.pdf>.
- <sup>19</sup> U.S. Department of Energy, National Energy Technology Laboratory. “Cement” (article section). Available at: <http://www.netl.doe.gov/kmd/cds/disk11/advdrilling.htm>.
- <sup>20</sup> U.S. Department of Energy, National Energy Technology Laboratory. “Fact Sheet, Evaluation of Foamed Wellbore Cement Stability Under Deep Water Conditions.” Available at: <http://www.netl.doe.gov/publications/factsheets/rd/R&D187.pdf>.
- <sup>21</sup> U.S. Department of Energy, National Energy Technology Laboratory. “Smart Drilling” (article). Available at: <http://www.netl.doe.gov/kmd/cds/disk11/smartdrilling.htm>.
- <sup>22</sup> U.S. Department of the Interior: 10.1115/OMAE2011-49537. Conference: “ASME 2011 30th International Conference on Ocean, Offshore and Arctic Engineering, A Modelling Framework for Describing the Corrosion Fatigue Behavior of Carbon Steel Pipelines and Risers.” 2011. Available at: [http://www.researchgate.net/publication/267606263\\_A\\_Modelling\\_Framework\\_for\\_Describing\\_the\\_Corrosion\\_Fatigue\\_Behaviour\\_of\\_Carbon\\_Steel\\_Pipelines\\_and\\_Risers](http://www.researchgate.net/publication/267606263_A_Modelling_Framework_for_Describing_the_Corrosion_Fatigue_Behaviour_of_Carbon_Steel_Pipelines_and_Risers).
- <sup>23</sup> U.S. Department of Energy, Final Report RPSEA Project, 2012, 07121-DW-1603D, Rice University. “Structural Health Monitoring System for Deepwater Risers, with Vortex Induced Vibration.” Available at: [http://www.rpsea.org/media/files/project/e4a43576/07121-1603d-FR-Robotic\\_MFL\\_Sensor\\_Monitoring\\_Inspection\\_Deepwater\\_Risers-07-02-12\\_P.pdf](http://www.rpsea.org/media/files/project/e4a43576/07121-1603d-FR-Robotic_MFL_Sensor_Monitoring_Inspection_Deepwater_Risers-07-02-12_P.pdf).
- <sup>24</sup> U.S. Department of Energy, RPSEA. “Subsea Robotics: Making Science Fiction a Reality for Offshore Oil and Gas,” 2012. Available at: <http://www.rpsea.org/articles/subsea-robotics-making-science-fiction-a-reality-for-offshore-oil-and-gas/>.
- <sup>25</sup> U.S. Department of the Interior, Bureau of Safety and Environmental Enforcement, July 30, 2012. “BSEE Announces Successful Completion of Deepwater Well Containment Exercise in the Gulf.” Available at: <http://www.bsee.gov/BSEE-Newsroom/Press-Releases/2012/BSEE-Announces-Successful-Completion-of-Deepwater-Well-Containment-Exercise-in-the-Gulf/>.
- <sup>26</sup> U.S. Department of Energy, RPSEA, Final Report. “Subsea Processing.” 07-1901, July 2011. Available at: [http://www.rpsea.org/media/files/project/d4215bf6/07121-1901-FR-Subsea\\_Processing\\_Simulator-07-15-11\\_P.pdf](http://www.rpsea.org/media/files/project/d4215bf6/07121-1901-FR-Subsea_Processing_Simulator-07-15-11_P.pdf).
- <sup>27</sup> Energy Information Administration. “Short-Term Energy Outlook.” May 12, 2015.
- <sup>28</sup> U.S. Department of Energy, National Energy Technology Laboratory. “Carbon Dioxide Enhanced Oil Recovery: Untapped Domestic Energy Supply and Long Term Carbon Storage Solution.” Available at: [https://www.netl.doe.gov/file%20library/research/oil-gas/small\\_CO2\\_EOR\\_Primer.pdf](https://www.netl.doe.gov/file%20library/research/oil-gas/small_CO2_EOR_Primer.pdf).
- <sup>29</sup> Hancock, S.; Moridis, G.; Wilson, S.; Robertson, A. “Well Design Requirements for Deepwater and Arctic Onshore Gas Hydrate Production Wells.” Proceedings, Offshore Technology Conference, OTC-21015, 2010; 7 pp.
- <sup>30</sup> Modified by R. Boswell from the original source: Boswell, R. “Is Gas Hydrate Energy Within Reach? *Science* (325), 2009; pp. 957–958.
- <sup>31</sup> Collett, T.; Agena, W.; Lee, M.; et al. “Assessment of Gas Hydrate Resources on the North Slope, Alaska.” *U.S. Geological Survey Fact Sheet 2008-3073*, 2008; 4 pp.
- <sup>32</sup> Rogner, H.-H.; et al. Chapter 7: “Energy Resources and Potentials.” In *Global Energy Assessment—Toward a Sustainable Future*. Cambridge University Press, Cambridge, UK, and New York, NY, USA, and the International Institute for Applied Systems Analysis, Laxenburg, Austria, pp. 423–512.
- <sup>33</sup> Development intensity is a phenomenon associated with shale development in part owing to the low recovery per well. Improved drilling and completion technologies are needed to reduce the number of wells drilling for the same recovery volume. Drilling intensity is discussed in the following report by Leonardo Maugeri, Associate, Environment and Natural Resources Program/Geopolitics of Energy Project, Discussion Paper 2013-05, Belfer Center for Science and International Affairs, Harvard Kennedy School: “The Shale Oil Boom: A U.S. Phenomenon.” 2013. Quote from report as follows: “Drilling intensity in U.S. shale oil plays skyrocketed from a few hundred wells brought online (e.g., becoming productive) before 2011 to more than 4,000 in 2012—a figure that outpaces the total number of oil and gas wells (both conventional and unconventional) brought online in the same year in the rest of the world (except Canada).” Available at: [http://belfercenter.ksg.harvard.edu/publication/23191/shale\\_oil\\_boom.html](http://belfercenter.ksg.harvard.edu/publication/23191/shale_oil_boom.html).

- <sup>34</sup> International Energy Agency. “Golden Rules for the Golden Age of Gas.” World Energy Outlook Special Report on Unconventional Gas, 2012.
- <sup>35</sup> U.S. Department of Energy, U.S. Department of the Interior, U.S. Environmental Protection Agency. “Federal Multiagency Collaboration on Unconventional Oil and Gas Research: A Multi-Year Strategy for Research and Development.” 2014.
- <sup>36</sup> Since 1924, the American Petroleum Institute has been developing equipment and operating standards for the oil and natural gas industry. Available at: <http://www.api.org>.
- <sup>37</sup> Ellsworth, W. L. “Injection-Induced Earthquakes.” Journal Article 2013, July 12, 2013, Science 10.1126/science.1225942 341 6142. Available at: <http://www.sciencemag.org/content/341/6142/1225942>.
- <sup>38</sup> National Research Council. “Induced Seismicity Potential in Energy Technologies.” 2013, p. 9.
- <sup>39</sup> U.S. Department of Energy, U.S. Department of the Interior, U.S. Environmental Protection Agency. “Federal Multiagency Collaboration on Unconventional Oil and Gas Research: A Multi-Year Strategy for Research and Development.” 2014.
- <sup>40</sup> Presentation of the Department of Mineral Resources review of North Dakota Petroleum Council Flaring Task Force Report and Consideration of Implementation Steps, March 3, 2014.
- <sup>41</sup> EPA, Climate Change, Overview of Greenhouse Gases, Table “Properties of Methane.” Available at: <http://epa.gov/climatechange/ghgemissions/gases/ch4.html>.
- <sup>42</sup> Intergovernmental Panel on Climate Change. “Climate Change 2013: The Physical Science Basis.” Table 8.A.1
- <sup>43</sup> Environmental Protection Agency. “Inventory of Greenhouse Gas Emissions and Sinks: 1990-2012.” Table ES-2, 2014. Available at: <http://www.epa.gov/climatechange/Downloads/ghgemissions/US-GHG-Inventory-2014-Chapter-Executive-Summary.pdf>.
- <sup>44</sup> National Petroleum Council. “Arctic Potential: Realizing the Promise of U.S. Arctic Oil and Gas Resources.” 2015. Available at: <http://www.npcarcticpotentialreport.org/>.
- <sup>45</sup> Boswell, R.; Collett, T.; Frye, M.; Shedd, W.; McConnell, D.; Shelander, D. “Subsurface Gas Hydrates in the Northern Gulf of Mexico.” *Journal of Marine and Petroleum Geology* (34:1), 2012; pp. 4-30.
- <sup>46</sup> Bureau of Ocean Energy Management. “Assessment of In-place Gas Hydrate Resources of the Lower 48 United States Outer Continental Shelf.” BOEM Fact Sheet, RED-2012-01 2012.
- <sup>47</sup> National Petroleum Council. “Prudent Development: Realizing the Potential of North America’s Abundant Natural Gas and Oil Resources.” 2011, Table 1-3, Natural Gas Resource Base, p. 72.
- <sup>48</sup> National Petroleum Council. “Arctic Potential: Realizing the Promise of U.S. Arctic Oil and Gas Resources.” 2015. Available at: <http://www.npcarcticpotentialreport.org/>.
- <sup>49</sup> U.S. Department of Energy. 2011. U.S. Billion-Ton Update: Biomass Supply for a Bioenergy and Bioproducts Industry. R.D. Perlack and B.J. Stokes (Leads), ORNL/TM-2011/224. Oak Ridge National Laboratory, Oak Ridge, TN. 227p.
- <sup>50</sup> Ruth, M.; Mai, T.; Newes, E.; Aden, A.; Warner, E.; Uriarte, C.; Inman, D.; Simpkins, T.; Argo, A. (March 2013). Projected Biomass Utilization for Fuels and Power in a Mature Market. Transportation Energy Futures Series. Prepared for the U.S. Department of Energy by National Renewable Energy Laboratory, Golden, CO. DOE/GO-102013-3707. 153 pp. <http://www.nrel.gov/docs/fy13osti/53336.pdf>
- <sup>51</sup> Ibid
- <sup>52</sup> “Bioenergy Technology Office Multi-Year Program Plan.” 2015. Available at: [http://energy.gov/sites/prod/files/2015/04/f22/mypp\\_beto\\_march2015.pdf](http://energy.gov/sites/prod/files/2015/04/f22/mypp_beto_march2015.pdf).
- <sup>53</sup> Further information is available at: <http://epa.gov/otaq/fuels/renewablefuels/index.htm> and <http://www.arb.ca.gov/fuels/lcfs/lcfs.htm>.
- <sup>54</sup> Jointly funded by the Department of Navy, U.S. Department of Energy, and U.S. Department of Agriculture with cost share from the private sector.
- <sup>55</sup> Kenney, K. L.; et al. “Feedstock Supply System Design and Economics for Conversion of Lignocellulosic Biomass to Hydrocarbon Fuels—Conversion Pathway: Biological Conversion of Sugars to Hydrocarbons.” INL/EXT-13-30342, 2013. Available at: <https://inlportal.inl.gov/portal/server.pt?open=512&objID=421&parentname=CommunityPage&parentid=48&mode=2>.
- <sup>56</sup> Biomass Resource and Development Library, funded by BETO and house at Idaho National Lab, Idaho Falls, ID. Available at: [https://inlportal.inl.gov/portal/server.pt/community/renewable\\_energy\\_home/419/biomass\\_resource\\_library](https://inlportal.inl.gov/portal/server.pt/community/renewable_energy_home/419/biomass_resource_library).
- <sup>57</sup> “Bioenergy Technology Office Multi-Year Program Plan.” 2015. Available at: [http://energy.gov/sites/prod/files/2015/04/f22/mypp\\_beto\\_march2015.pdf](http://energy.gov/sites/prod/files/2015/04/f22/mypp_beto_march2015.pdf).
- <sup>58</sup> Gregorova, A.; et al. “Stabilization Effect of Lignin in Natural Rubber.” *Polymer Degradation and Stability* (91:229), 2006.
- <sup>59</sup> Demirbas, A. “Relationship Between Lignin Contents and Heating Values of Biomass.” *Energy Conversion and Management* (42:183), 2001.
- <sup>60</sup> “National Algal Biofuels Technology Roadmap.” May 2010. Available at: [http://www.energy.gov/sites/prod/files/2014/03/f14/algal\\_biofuels\\_roadmap.pdf](http://www.energy.gov/sites/prod/files/2014/03/f14/algal_biofuels_roadmap.pdf).
- <sup>61</sup> [1] Davis, R.; Fishman, D.; Frank, E.; et al. “Renewable Diesel from Algal Lipids: An Integrated Baseline for Cost, Emissions, and Resource Potential from a Harmonized Model.” Argonne National Laboratory, ANL/ESDA/12-4, 2012. Available at: <http://greet.es.anl.gov/publication-algae-harmonization-2012>.
- [2] Davis, R.; Kinchin, C.; Markham, J.; Tran, E. C. D.; et al. “Process Design and Economics for the Conversion of Algal Biomass to Biofuels.” National Renewable Laboratory, 2014.

- <sup>62</sup> Jones, S.; Tan, E.; Jacobson, J.; et al. "Process Design and Economics for the Conversion of Lignocellulosic Biomass to Hydrocarbon Fuels Fast Pyrolysis and Hydrotreating Bio-oil Pathway." PNNL-23053, NREL/TP-5100-61178, 2013. Pacific Northwest National Laboratory, National Renewable Energy Laboratory, and Idaho National Laboratory. Available at: [http://www.pnnl.gov/main/publications/external/technical\\_reports/PNNL-23053.pdf](http://www.pnnl.gov/main/publications/external/technical_reports/PNNL-23053.pdf).
- <sup>63</sup> J.E. Holladay, White, J.F., Bozell, J.J., Johnson, D., "Top Value-Added Chemicals from Biomass: Volume II – Results of Screening for Potential Candidates from Biorefinery Lignin.", Pacific Northwest National Laboratory, PNNL-16983 (2007). Available at: [http://www.pnl.gov/main/publications/external/technical\\_reports/PNNL-16983.pdf](http://www.pnl.gov/main/publications/external/technical_reports/PNNL-16983.pdf).
- <sup>64</sup> "U.S. Billion Ton Update: Biomass Supply for a Bioenergy and Bioproducts Industry." August 2011. Available at: [http://www.energy.gov/sites/prod/files/2015/01/f19/billion\\_ton\\_update\\_0.pdf](http://www.energy.gov/sites/prod/files/2015/01/f19/billion_ton_update_0.pdf).
- <sup>65</sup> "Breaking the Chemical and Engineering Barriers to Lignocellulosic Biofuels: Next Generation Hydrocarbon Biorefineries." March 2008. Available at: <http://energy.gov/sites/prod/files/2014/04/f14/Roadmap2-08.pdf>.
- <sup>66</sup> For more information, see the "Hydrogen" chapter in the "NPC Future Transportation Fuels Study: Advancing Technology for America's Transportation Future." 2012. Available at: <http://www.npc.org/FTF-80112.html>. See also the NREL report "Hydrogen Pathways: Updated Cost, Well-to-Wheels Energy Use and Emissions for the Current Technology Status of Ten Hydrogen Production, Delivery, and Distribution Scenarios." 2013. Available at: <http://www.nrel.gov/docs/fy14osti/60528.pdf>. See also the "Report of the Hydrogen Production Expert Panel: A Subcommittee of the Hydrogen & Fuel Cell Technical Advisory Committee." 2013. Available at: [http://www.hydrogen.energy.gov/pdfs/hpep\\_report\\_2013.pdf](http://www.hydrogen.energy.gov/pdfs/hpep_report_2013.pdf).
- <sup>67</sup> Public announcements by Hyundai, Toyota, and others, with confirmation by the California Air Resources Board (in correspondence between Catherine Dunwoody and Tien Nguyen of the U.S. Department of Energy Fuel Cell Technologies Office.).
- <sup>68</sup> U.S. Department of Energy, Fuel Cell Technologies Office Program Record #12014, "Current U.S. Hydrogen Production" Available at: [http://www.hydrogen.energy.gov/pdfs/12014\\_current\\_us\\_hydrogen\\_production.pdf](http://www.hydrogen.energy.gov/pdfs/12014_current_us_hydrogen_production.pdf).
- <sup>69</sup> From the "Hydrogen" chapter in the NPC Report: "Large Hydrogen Production Facilities (>18,000 kg/day) Exist in Nearly Every State, Supplying Approximately 1,000 Locations with Bulk Hydrogen." Available at: <http://www.npc.org/FTF-80112.html>.
- <sup>70</sup> Estimated emissions from hydrogen production in China exceed 150 million tons per year.
- <sup>71</sup> To achieve a range comparable to commercial gasoline vehicles, FCEV tanks are filled to a pressure of 700 bar to provide 5.6 kg of hydrogen within the volume available. When range is not critical to the application or larger volumes are available (such as on board a bus), 350 bar storage systems may be used. Lower-pressure systems offer improved reliability and cost benefits over the high pressure systems. Note that 1 kg of hydrogen has approximately the same energy as 1 gallon of gasoline (i.e., 1 gasoline gallon equivalent). See Fuel Cell Technologies Office Program Record #13010, "Onboard Type IV Compressed Hydrogen Storage Systems—Current Performance and Cost," Available at: [http://www.hydrogen.energy.gov/pdfs/13010\\_onboard\\_storage\\_performance\\_cost.pdf](http://www.hydrogen.energy.gov/pdfs/13010_onboard_storage_performance_cost.pdf).
- <sup>72</sup> For more information on hydrogen production pathways, see the "US Drive Hydrogen Production Technical Team Roadmap (2013)." Available at: [http://www1.eere.energy.gov/vehiclesandfuels/pdfs/program/hptt\\_roadmap\\_june2013.pdf](http://www1.eere.energy.gov/vehiclesandfuels/pdfs/program/hptt_roadmap_june2013.pdf) and the 2013 NREL "Hydrogen Pathways Report." Available at: <http://www.nrel.gov/docs/fy14osti/60528.pdf>.
- <sup>73</sup> For more information on gasification, see Chapter 4, "Power Generation."
- <sup>74</sup> U.S. Department of Energy, National Renewable Energy Laboratory. "Biogas and Fuel Cells Workshop Summary Report." January 2013. Available at: <http://energy.gov/eere/fuelcells/downloads/biogas-and-fuel-cells-workshop-summary-report-proceedings-biogas-and-fuel>.
- <sup>75</sup> U.S. Department of Energy, Fuel Cell Technologies Office, July 2014. "2014 Electrolytic Hydrogen Production Summary Report." Available at: [http://energy.gov/sites/prod/files/2014/08/f18/fcto\\_2014\\_electrolytic\\_hydrogen\\_production\\_workshop\\_summary\\_report.pdf](http://energy.gov/sites/prod/files/2014/08/f18/fcto_2014_electrolytic_hydrogen_production_workshop_summary_report.pdf).
- <sup>76</sup> For more information, see <http://energy.gov/eere/fuelcells/photoelectrochemical-working-group>. High solar-to-hydrogen (STH) conversion efficiencies are possible in the emerging production pathways such as photoelectrochemical (PEC) water splitting. For example, a dual band gap PEC solar water splitting system, developed by stacking two materials in tandem, has an ideal theoretical efficiency of 41%, with a chemical solar-to-hydrogen conversion efficiency of 27% when including losses owing to the fraction of unused energy per absorbed photon (*Chemical Reviews* [110:11], 2010; pp. 6448-6449). To date, laboratory-scale demonstrations exceeding 15% STH have been achieved, but cost, durability, and scale-up issues remain (*Energy Environ. Sci.* [6], 2013; p. 1984).
- <sup>77</sup> U.S. Department of Energy, Fuel Cell Technologies Office. "2013 Biological Hydrogen Workshop Summary Report." November 2013. Available at: <http://energy.gov/eere/fuelcells/downloads/2013-biological-hydrogen-production-workshop-summary-report>. Hydrogen production efficiencies in the biological pathways remain low. Genetic manipulation of the hydrogen-producing organisms is needed to improve efficiency, rate, and yield.
- <sup>78</sup> Hydrogen production and delivery pathway roadmaps have been developed by the USDRIVE Hydrogen Production and Hydrogen Delivery Technical Teams. Available at: [http://www1.eere.energy.gov/vehiclesandfuels/pdfs/program/hptt\\_roadmap\\_june2013.pdf](http://www1.eere.energy.gov/vehiclesandfuels/pdfs/program/hptt_roadmap_june2013.pdf), [http://energy.gov/sites/prod/files/2014/02/f8/hdtt\\_roadmap\\_june2013.pdf](http://energy.gov/sites/prod/files/2014/02/f8/hdtt_roadmap_june2013.pdf). An updated combined version is available at: [http://www.hydrogen.energy.gov/pdfs/review15/pd000\\_miller\\_2015\\_o.pdf](http://www.hydrogen.energy.gov/pdfs/review15/pd000_miller_2015_o.pdf).
- <sup>79</sup> Fuel economies for all fuel/vehicle systems were determined by using Argonne National Laboratory's autonomie modeling system. See [http://www.transportation.anl.gov/modeling\\_simulation/PSAT/autonomie.html](http://www.transportation.anl.gov/modeling_simulation/PSAT/autonomie.html).
- <sup>80</sup> U.S. Department of Energy, Fuel Cell Technologies Office. Program Record # 13013, "On-Board Type IV Compressed Hydrogen Storage Systems—Current Performance and Cost." 2013. Available at: [http://www.hydrogen.energy.gov/pdfs/13010\\_onboard\\_storage\\_performance\\_cost.pdf](http://www.hydrogen.energy.gov/pdfs/13010_onboard_storage_performance_cost.pdf).

- <sup>81</sup> U.S. Department of Energy, Fuel Cell Technologies Office. Program Record # 12024, “Hydrogen Production Cost Using Low-Cost Natural Gas.” 2012. Available at: [http://www.hydrogen.energy.gov/pdfs/12024\\_h2\\_production\\_cost\\_natural\\_gas.pdf](http://www.hydrogen.energy.gov/pdfs/12024_h2_production_cost_natural_gas.pdf).
- <sup>82</sup> U.S. Department of Energy, Fuel Cell Technologies Office. Program Record #11007, “Hydrogen Threshold Cost Calculation.” 2011. Available at: [http://www.hydrogen.energy.gov/pdfs/11007\\_h2\\_threshold\\_costs.pdf](http://www.hydrogen.energy.gov/pdfs/11007_h2_threshold_costs.pdf).
- <sup>83</sup> Cost targets include the onboard efficiency benefits of FCEVs, as described in the Fuel Cell Technologies Office Program Record #13006, “Life-Cycle Costs of Mid-size Light-Duty Vehicles.” Available at: [http://www.hydrogen.energy.gov/program\\_records.html](http://www.hydrogen.energy.gov/program_records.html).
- <sup>84</sup> For additional details, please see Fuel Cell Technologies Office Program Record #14013. Available at: [http://www.hydrogen.energy.gov/pdfs/14013\\_hydrogen\\_early\\_market\\_cost\\_target.pdf](http://www.hydrogen.energy.gov/pdfs/14013_hydrogen_early_market_cost_target.pdf).
- <sup>85</sup> For more information on CHHP, see Chapter 4, “Power Generation.”
- <sup>86</sup> Analysis was completed by using the H2A Hydrogen Production Model (available at: [http://www.hydrogen.energy.gov/h2a\\_prod\\_studies.html](http://www.hydrogen.energy.gov/h2a_prod_studies.html)) and assumes high volume. Ranges reflect variability in major feedstock pricing as well as a bounded range for capital cost estimates, as described in the Fuel Cell Technologies Office Program Record #14005, “Hydrogen Production Status 2006–2013.” Available at: [http://www.hydrogen.energy.gov/pdfs/14005\\_hydrogen\\_production\\_status\\_2006-2013.pdf](http://www.hydrogen.energy.gov/pdfs/14005_hydrogen_production_status_2006-2013.pdf).
- <sup>87</sup> The amount of hydrogen fuel required in the near term can be extrapolated from the California Air Resources Board’s “Annual Evaluation of Fuel Cell Electric Vehicle Deployment and Hydrogen Fuel Station Network Development,” June 2014. For additional information, see NREL’s 2013 “Resource Assessment for Hydrogen Production: Hydrogen Production Potential from Fossil and Renewable Energy Resources” (available at: <http://www.nrel.gov/docs/fy13osti/55626.pdf>), the National Hydrogen Association’s 2010 market report (available at: [www.tccorp.com/pdf/marketReport.pdf](http://www.tccorp.com/pdf/marketReport.pdf)), and/or the IEA’s North American Roadmap workshop (available at: <http://www.iea.org/media/workshops/2014/hydrogenroadmap/7doericmiller.pdf>). Additional public hydrogen fueling stations will, however, be required to meet vehicle demand.
- <sup>88</sup> Feedstock cost ranges used in the case studies are \$4–\$10 per MMBTU for SMR, \$0.03–\$0.08 per kWh for PEM electrolysis, and \$40–\$120 per dry short ton for biomass gasification, consistent with the Fuel Cell Technologies Office Program Record #14005.
- <sup>89</sup> See the 2013 NREL “Hydrogen Pathways Report.” Available at: <http://www.nrel.gov/docs/fy14osti/60528.pdf>.
- <sup>90</sup> International Atomic Energy Agency. Nuclear Hydrogen Production Technology. Available at: [http://www.iaea.org/About/Policy/GC/GC57/GC57InfDocuments/English/gc57inf-2-att1\\_en.pdf](http://www.iaea.org/About/Policy/GC/GC57/GC57InfDocuments/English/gc57inf-2-att1_en.pdf).
- <sup>91</sup> U.S. Department of Energy, “Fuel Cell Technologies Office Multi-Year Research, Development, and Demonstration Plan, Hydrogen Delivery,” 2015, p. 3.2-2. Available at: [http://energy.gov/sites/prod/files/2015/05/f22/fcto\\_myRDD\\_delivery\\_0.pdf](http://energy.gov/sites/prod/files/2015/05/f22/fcto_myRDD_delivery_0.pdf).
- <sup>92</sup> Dunwoody, C. “California Fuel Cell Partnership, 2014, FCEVs and H2 in California.” [http://www.hydrogen.energy.gov/pdfs/review14/dunwoody\\_plenary\\_2014\\_amr.pdf](http://www.hydrogen.energy.gov/pdfs/review14/dunwoody_plenary_2014_amr.pdf).
- <sup>93</sup> California Fuel Cell Partnership. “CA H2 Station Maps.” 2015. Available at: <http://cafcp.org/sites/files/H2-Station-CA-map-Open-Funded-2015.pdf>.
- <sup>94</sup> Information throughout this paragraph is from the U.S. Department of Transportation, industry sources, market research firms, and other sources (source: EERE Fuel Cell Technologies Office, Tien Nguyen).
- <sup>95</sup> U.S. Department of Energy, Fuel Cell Technologies Office. Program Record # 13013, “On-Board Type IV Compressed Hydrogen Storage Systems—Current Performance and Cost.” 2013. Available at: [http://www.hydrogen.energy.gov/pdfs/13010\\_onboard\\_storage\\_performance\\_cost.pdf](http://www.hydrogen.energy.gov/pdfs/13010_onboard_storage_performance_cost.pdf).
- <sup>96</sup> Chapter 8 on transportation includes a discussion of RD&D needs and performance targets for onboard hydrogen storage in vehicles. Part of the RD&D on advanced storage materials and systems for onboard storage may be applicable to the storage systems used for tube trailers and at hydrogen fueling stations (refer to Chapter 8 for RD&D needs and priorities). Chapter 6 discusses RD&D for components and materials for energy technologies. Similarly, low-carbon electricity sources are discussed in the power chapter and are not addressed here.
- <sup>97</sup> U.S. Department of Energy, Fuel Cell Technologies Office. “Multi-Year Research, Development, and Demonstration Plan.” 2012 update. Available at: <http://energy.gov/eere/fuelcells/downloads/fuel-cell-technologies-office-multi-year-research-development-and-22>.
- <sup>98</sup> EIA. “Annual Energy Outlook 2014: World Production of Liquid Fuels from Biomass, Coal, and Natural Gas Increases. Available at: [http://www.eia.gov/forecasts/aeo/MT\\_intl.cfm](http://www.eia.gov/forecasts/aeo/MT_intl.cfm).
- <sup>99</sup> “Affordable, Low-Carbon Diesel Fuel from Domestic Coal and Biomass.” DOE/NETL-2009/1349, January 14, 2009. Available at: <http://www.netl.doe.gov/File%20Library/Research/Energy%20Analysis/Coal/CBTL-Final-Report.pdf>.
- <sup>100</sup> Lin, G, Larson, E.D., Williams, R.H., Guo, Xiangbo, “Gasoline from Coal and/or Biomass with CO<sub>2</sub> Capture and Storage. 1. Process Designs and Performance Analysis,” *Energy & Fuels*, 2015, V.29, pp.1830-1844. See also: “Affordable, Low-Carbon Diesel Fuel from Domestic Coal and Biomass.” DOE/NETL-2009/1349, January 14, 2009. Available at: <http://www.netl.doe.gov/File%20Library/Research/Energy%20Analysis/Coal/CBTL-Final-Report.pdf>.
- <sup>101</sup> Eric D. Larson, Giulia Fiorese, Guangjian Liu, Robert H. Williams, Thomas G. Kreutz, Stefano Consonni, “Co-Production of decarbonized synfuels and electricity from coal + biomass with CO<sub>2</sub> capture and storage: an Illinois case study,” *Energy & Environmental Science* 2010, V.3, pp.28-42.





## Issues and RDD&D Opportunities

- Transportation accounts for 10% of U.S. gross domestic product and provides essential services throughout the economy and for quality of life. It also represents 70% of all U.S. petroleum use and 27% of U.S. greenhouse gas (GHG) emissions.
- Research opportunities to reduce the sector's petroleum use and GHG emissions include the following:
  - **Combustion efficiency:** Significant opportunities exist for improving internal combustion engines, which dominate today's vehicle fleet. Improving internal combustion engines requires research in simulation, sensors, controls, materials, and engine waste heat recovery, as well as new combustion strategies.
  - **Co-optimization of fuels and engines:** Current fuels constrain engine design due to knock performance. New high-performance, low-carbon fuels that are co-optimized (designed in tandem) with engines could improve both performance and efficiency.
  - **Lightweighting:** Reduced vehicle weight improves vehicle efficiency and range. Research focuses on new materials such as advanced, high-strength steel, aluminum, magnesium alloys, and carbon fiber polymer matrix composites.
  - **Plug-in electric vehicles (PEVs):** PEVs have efficient drivetrains and allow for petroleum-free and lower-carbon fueling options, but need further improvements that will require research in new battery designs and chemistries to reduce cost and recharge time while improving energy density, power electronics and motors, and system design.
  - **Fuel cell electric vehicles (FCEVs):** FCEVs can be refueled in minutes, meet a wide range of performance requirements, achieve a better than 300-mile driving range, and have zero emissions from the tailpipe, while offering large potential petroleum and GHG reductions. Key issues are fuel cell cost and durability, and on-board hydrogen storage.
  - **Other modes:** Projected activity growth in off-road transportation (e.g., air, rail, and marine) will make efficiency of these modes increasingly important.
  - **Connected and automated vehicles:** Vehicle connectivity and automation present a variety of potential energy benefits and risks. Research opportunities include supporting technologies (sensors, computation, communications, and control) as well as system research to improve energy outcomes.
  - **Transportation systems:** A systems perspective on transportation, incorporating the interactions between (for example) vehicles, infrastructure, information technology, and human behavior, will enable future investment to optimize energy use through smarter transportation systems and technologies.



# 8

## Advancing Clean Transportation and Vehicle Systems and Technologies

### 8.1 Introduction

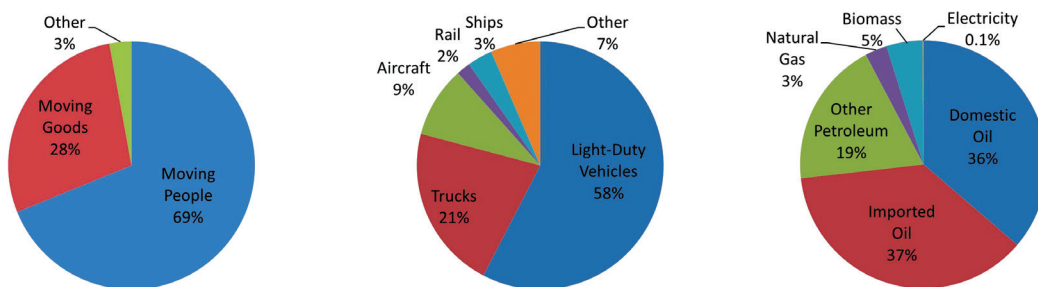
Transportation provides essential services for the economy, but also produces significant negative impacts, including economic costs and risks of dependence on oil, environmental impacts on air quality and health, and greenhouse gas (GHG) emissions. A wide range of technologies at various stages in the research and development pipeline offer the potential to mitigate these impacts. This chapter evaluates these technologies based on their potential for impact. The technology portfolio evaluated here could, if successfully developed and deployed by the market, dramatically reduce transportation impacts.

#### The Problem

Transportation is a complex system composed of light-duty, medium-duty, and heavy-duty ground support, and material handling vehicles; rail; aircraft; and ships used for personal transport, movement of goods, construction, agriculture, and mining as well as associated infrastructure. Vehicle operations may include very different duty cycles, even for similar vehicles. For example, trucks are operated in short- or long-haul contexts and passenger cars for personal or various commercial uses, for many hours a day or much less. Transportation is approximately 10% of gross domestic product (GDP) and depends on significant public sector investment for development and maintenance of roads, traffic management, transit, airports, ports, and waterways. In 2007 (the latest data available), federal and local governments spent \$255.1 billion dollars on transportation infrastructure—1.7% of all GDP.<sup>1</sup>

Overall, the United States uses 21% of the world's oil supply and produces 11% of the world's oil, but it has just 2% of the world's proven oil reserves.<sup>2</sup> Transportation uses 25 quadrillion British thermal units (Btu) of petroleum annually, representing 70% of all U.S. petroleum use, and 93% of energy for transportation is from petroleum, which means that any strategy to improve our economic and energy security by reducing our dependence on petroleum must include transportation. Transportation energy use by purpose, mode, and energy source is shown in Figure 8.1.

**Figure 8.1** Composition of 2014 Energy Use in Transportation<sup>3</sup>



Transportation in the United States produces 1.8 gigatons of carbon dioxide (CO<sub>2</sub>)-equivalent GHG emissions (27% of U.S. totals)<sup>4</sup> and is a significant source of criteria pollutants, particularly nitrogen oxide (NO<sub>x</sub>), carbon monoxide, and particulate matter (PM). Emissions have fallen steadily, however, over the last four decades due to emission control requirements. Despite this progress, significant additional changes will be needed to enable a transportation system that contributes to the economy-wide reductions in GHGs called for in long-term goals.<sup>5</sup> Other systemic costs include loss of time due to traffic congestion, loss of life and property damage from accidents, noise, harm to habitat, and the other opportunity costs such as real estate used for parking lots rather than economically productive use or shared open space. Transportation fuel accounts for the majority of average household energy costs—nearly \$4,000 per household in 2014.

Petroleum use and emissions by mode are given in Table 8.1. Transportation also represents 54% of all carbon monoxide emissions, 59% of NO<sub>x</sub> emissions, and 23% of volatile organic compound emissions.<sup>6</sup>

**Table 8.1** Annual Petroleum Use and Emissions by Mode (2012)<sup>7</sup>

Mode	Petroleum use (quads)	Emissions (million metric tonnes CO <sub>2</sub> )
Light-duty vehicles	15.3	1,065
Medium-duty vehicles*	1.5	88
Heavy-duty vehicle	4.5	320
Off-road**	2.1	Not estimated
Rail	0.6	44
Marine	1.2	37
Aviation	2.1	145
<b>Total</b>	<b>27.3</b>	

\* Includes buses

\*\* Includes industrial, mining, and agricultural equipment (often counted in the industrial sector)

## The Opportunity

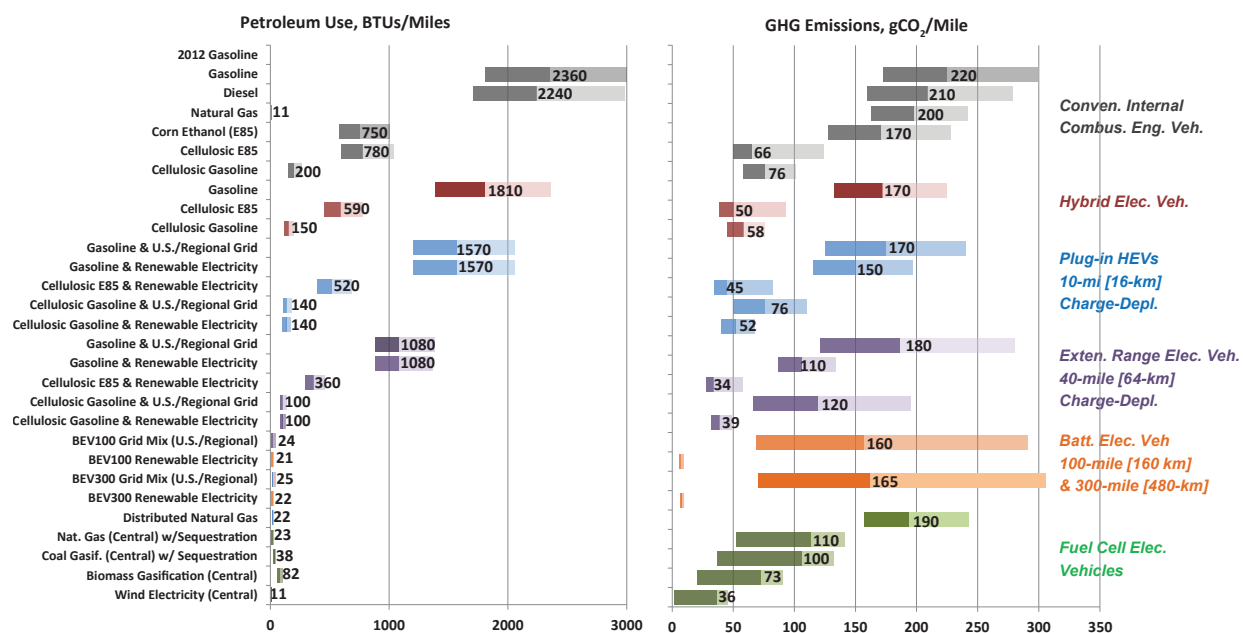
The need for a safe, fuel-efficient, operationally efficient, low-emission, and flexible transportation system can be addressed by advanced technology throughout the transportation system. The need to address energy security concerns and oil import costs has long been a national priority driving DOE transportation technology research on efficient vehicle drivetrains, including efficient combustion vehicles, plug-in electric vehicles, and fuel cell vehicles. Future personal vehicle markets—in which these efficient vehicle technologies compete—may be transformed, and perhaps reduced in size, by information technologies as well as by social and demographic trends. Under the right circumstances, information technology can offer a less costly and less energy-intensive alternative to vehicular transportation. Low or zero tailpipe emissions technologies, including plug-in electric vehicles and fuel cell vehicles, address the need for cleaner transportation to improve air quality, especially in busy metropolitan areas and ports. Technologies, including plug-in electric vehicles and fuel cell vehicles, offer the potential for greater integration between energy systems for transportation, electricity, and building, which could be pursued to improve overall efficiency and reduce emissions.

Technological change in the transportation sector can offer opportunities across a variety of dimensions, from improvements in transportation services to reduction in environmental impacts. One key environmental metric, GHG reduction, illustrates how technological change can produce the desired effect through different parts of the system, including energy intensity of vehicles, carbon intensity of fuels, and demand and system-use intensity. These strategies often correspond to different parts of the transportation system, though many technologies and systems can affect more than one factor. For example, electric drivetrain vehicles improve efficiency while simultaneously providing the opportunity to use lower-carbon fuels and other sources to generate the electricity.

There are broadly two types of metrics that are used to evaluate technology and system options: 1) viability metrics that assess how competitive a technology can be; and 2) impact metrics that estimate the benefits of successful research, demonstration, and deployment. Impact metrics include reduced GHG emissions (Figure 8.2), reduced petroleum use (Figure 8.2), improved energy efficiency, and economic benefits, as well as more systematic effects such as air quality, safety, and land use. Viability metrics include cost of driving (or total cost of ownership), vehicle performance and desirability, and infrastructure availability and compatibility. Targets for viability metrics are developed through technology roadmapping based on market needs and engineering-based analysis.

In assessing the research, development, demonstration, and deployment (RDD&D) opportunities among vehicle technologies, it is important to evaluate the costs and benefits of the different vehicle technologies using a number of analytical tools, such as techno-economic analysis, return on investment analysis (including financial, petroleum savings, and reduced GHGs), life-cycle assessments, and sustainability analysis (which encompasses diverse criteria and quantifiable evaluation metrics). These analyses are vital for identifying RDD&D options and establishing priorities for addressing near-term technology “choke points” as well as

**Figure 8.2** Well-to-Wheels Petroleum Use and GHG Emissions for 2035 Mid-Size Cars



Diverse technology options exist to reduce transportation petroleum use and GHG emissions. The only options that achieve very high petroleum reductions and very low carbon emissions combine electric drive with low-carbon fuels. Contributions of vehicle cycle, fuel production, and vehicle operations are given in the Technology Assessments.<sup>11</sup>

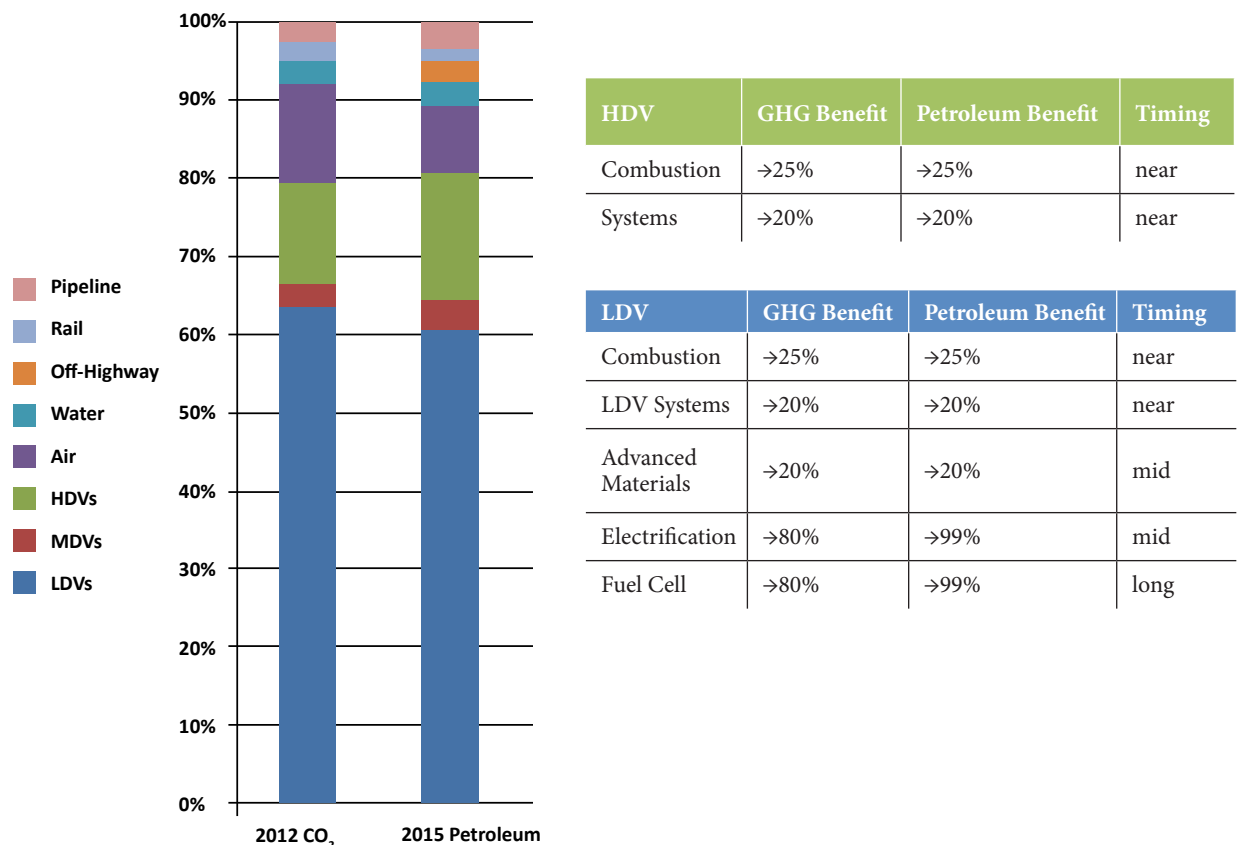
longer-term step-changing innovations. Basic science research is needed that links effectively with applied RDD&D conducted with strong industry engagement. A number of groups in industry, government, and academia have adopted similar analytical approaches for emphasizing the RDD&D needs in vehicle technology, including federal advisory groups such as the National Petroleum Council,<sup>8</sup> the Secretary of Energy Advisory Board,<sup>9</sup> and the National Academy of Sciences/National Academy of Engineering.<sup>10</sup>

Particular attention is given to early-stage innovations and technologies, where the social benefit may be very high and yet the incentives for companies to invest in many of these research and development (R&D) activities are lower than in later-stage technologies that are being commercialized anyway.

### Overall Impact Potential

Throughout this chapter, technology system analyses include assessments of the impact of successful deployment of those technologies. In aggregate, the technologies evaluated here could have a very significant effect on the petroleum use and GHG emissions of light-duty vehicle (LDV) and heavy-duty vehicles (HDVs), as shown in Figure 8.3. The combined impacts of technologies evaluated here could have a long-term reduction

**Figure 8.3** Potential Benefits of Advanced Transportation Technologies



Improved LDV and HDV systems have the potential for significant reductions in transportation petroleum use and GHG emissions. These figures are aggregated from the technology sections. Each estimate is calculated as the per-vehicle impacts times the total opportunity for the affected mode(s). This is intended only as a reference point and not a goal or forecast. Estimates cannot be combined directly with other impact potentials in this chapter due to double counting. (Source: DOE)

in LDV GHG emissions and petroleum use of more than 80%, and a long-term reduction in HDV GHG emissions and petroleum use of approximately 50%. Impacts for other modes and from automation are a newer area of study and are not included here due to higher uncertainty. Technology analysis evaluates a wide range of possible impacts due to technology and market factors; upper values are provided here for simplicity.

The total size of the potential to reduce the negative impacts of transportation through technology has been a subject of significant study. Several studies have identified technology options for greater than 80% reduction in emissions and petroleum use. A recent National Academies study<sup>12</sup> found that several pathways exist to reduce petroleum use and emissions for light-duty vehicles, and a DOE study, *Transportation Energy Futures*,<sup>13</sup> found that there is potential—through a combination of system, vehicle, and fuel improvements—to reduce transportation petroleum use and emissions by more than 80% overall. Each study noted that a portfolio of technologies and a systems perspective is likely to be pivotal for successful transformation of the transportation system.

## The Challenge

Despite the size of the opportunity to impact petroleum usage and GHG emissions, transportation poses a key challenge due to the long fleet life, complex customer needs, and the entrenched nature of petroleum fuels and combustion engine vehicles. For example, advanced technologies in light-duty vehicles have often taken fifteen years or more to be incorporated into all vehicles sold, and vehicles will often remain on the road for fifteen years or more after purchase.

Because of the high price of petroleum products relative to other energy forms, the transportation sector is relatively insensitive to a carbon pricing mechanism compared to, for example, the electricity sector, indicating that transportation may be more challenging to transition to a low-carbon future unless multiple strategies are taken. For example, based on 2014 average gasoline prices, a \$38 per ton carbon price<sup>14</sup> would lead to only approximately a 9% increase in the direct cost of fuel.

### 8.1.1 Technology Approach

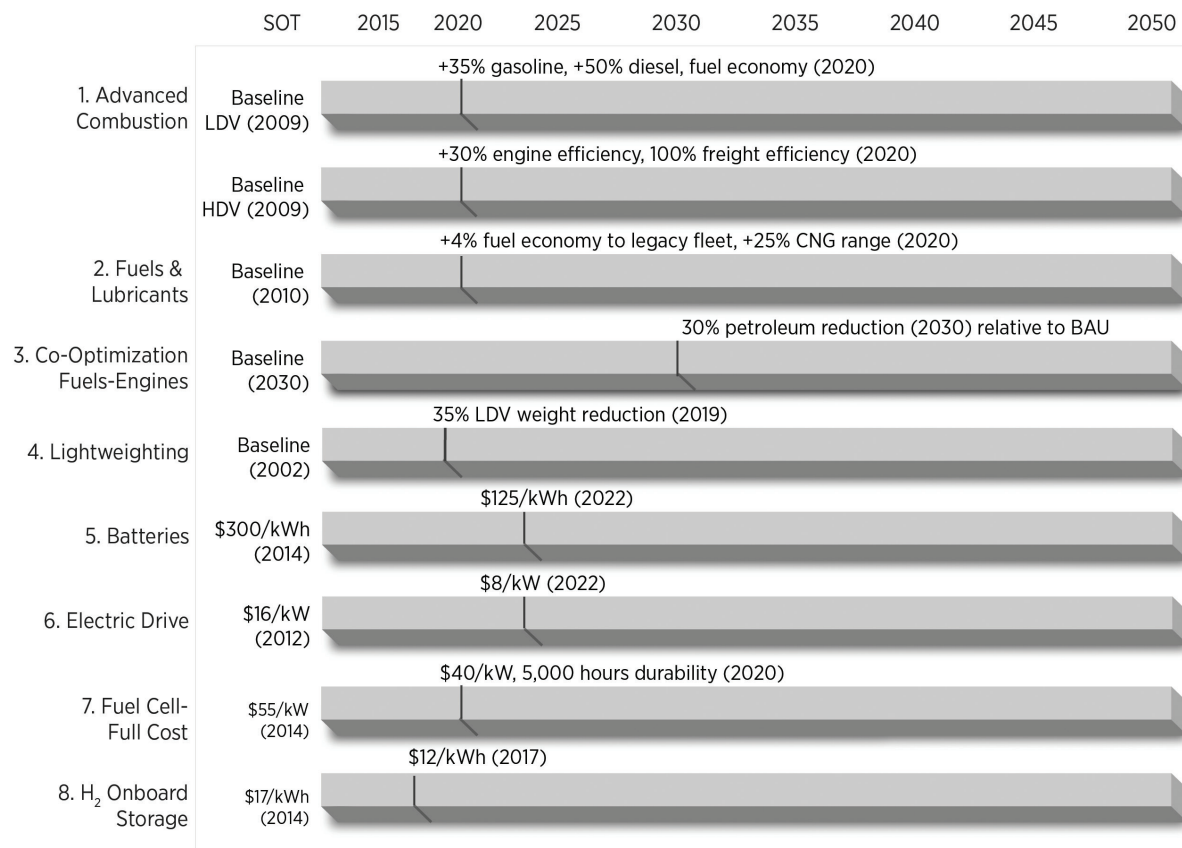
In this chapter, technologies are evaluated on the basis of their current state of technology and engineering-based projections of improvements (referred to in this chapter as “targets”) that may be achieved, over a variety of time frames, through RDD&D activities. Figure 8.4 shows an overview of key transportation technologies which will be discussed in this chapter.

### 8.1.2 Mapping the Opportunity Space: A Chapter Guide

This chapter is primarily organized around technology opportunities as they relate to the transportation modes. Several sections of the chapter update and evaluate the technology opportunities in core research areas for DOE, while others explore new opportunities. The combustion vehicle efficiency Section 8.2 addresses light-, medium-, and heavy-duty vehicle efficiency, including engine efficiency, advanced combustion, eBoost supercharging, and reduction of parasitic losses from emissions controls. The lightweighting Section 8.3 focuses on materials that include advanced high strength steels, aluminum alloys, magnesium alloys, carbon fiber and other composites, and mixed materials including material joining. The plug-in electric vehicles Section 8.4 addresses batteries and energy storage, power electronics and motors, and system and vehicle design. The hydrogen fuel cell vehicles Section 8.5 covers automotive fuel cells, onboard hydrogen storage, system and vehicle design, and fuel cells as auxiliary power units.

This chapter also addresses technology areas in transportation that are not currently a major investment area for DOE. The non-LDV modes Section 8.6 includes the efficiency potential in aircraft, marine, pipeline, rail, and off-road. The vehicle automation Section 8.7 examines the potential energy impacts of connected and automated vehicles, sensor development, infrastructure technologies, and automation outside the LDV sector.

**Figure 8.4** Overview of Key Transportation Technologies and Performance Targets Based on DOE Assessment of Current RDD&D Activities. Key research areas for each technology are listed in the lower box and are discussed in the main text.



- 1 Low-temperature combustion strategies to achieve higher engine efficiencies; more efficient, lower-cost approaches for reducing NO<sub>x</sub>, HC, and PM in low-temperature exhaust; system-level technologies to improve vehicle fuel economy through a combination of combustion strategies, emission control, fuel injection, air handling, waste heat recovery, and control systems; advanced materials to address limitations for advanced combustion regimes and engines
- 2 Alternative and renewable fuels; unique, non-conventional fuel properties to improve efficiency; lubricant technologies that can reduce friction losses in new and legacy vehicles
- 3 High-performance, low carbon fuels for high-efficiency engines; integration into production, distribution, and dispensing infrastructure
- 4 All vehicle systems (body, chassis, powertrain, closures, tires, bumpers) using advanced high-strength steels, aluminum and magnesium alloys, carbon fiber composites, and mixed material systems
- 5 High-voltage, high-capacity cathodes; advanced metal alloy and composite anodes; electrolytes; separators; surface films; cell fabrication, pack integration
- 6 Cost, performance, reliability, efficiency, packaging, weight, manufacturing of electric motors and power electronics, wide bandgap semiconductors, high-temp passive devices, interfaces, interconnects, laminations, windings, packaging, capacitors, magnetic materials, reduced rare earth materials
- 7 Lower-cost, more durable, non-platinum group metal catalysts and membrane electrode assemblies
- 8 Lower-cost, spatially/volumetrically efficient storage

The chapter concludes with a discussion of transportation system effects (see Section 8.8). This perspective can be more challenging to use when evaluating sector opportunities, but is potentially very useful for long-term R&D planning and is an emerging research need.

## 8.2 Vehicle Efficiency and Combustion Technologies

Improving fuel economy with advanced combustion engines and more energy efficient vehicle systems offers a significant potential to reduce the overall fuel consumption of the vehicle fleet. Table 8.2 outlines the estimated impacts from the technologies in this section if successfully deployed fleet wide.<sup>15</sup>

**Table 8.2** Combustion and Vehicle Efficiency Impact Summary (DOE calculations)

Technology system	R&D time frame	Per vehicle impacts		Long-term impact potential	
		GHG reduction	Petroleum reduction	Annual GHG reduction	Petroleum reduction
LDV combustion	To 2020	Up to 25%	Up to 25%	266 MMT	4.3 quads
LDV systems	To 2020	Up to 20%	Up to 20%	213 MMT	3.4 quads
HDV combustion	To 2020	Up to 25%	Up to 25%	80 MMT	1.2 quads
HDV systems	To 2020	Up to 20%	Up to 20%	64 MMT	0.9 quads

### 8.2.1 Internal Combustion Engines

Increasing the efficiency of internal combustion engines (ICEs) is one of the most promising and cost-effective approaches to dramatically improving the fuel economy of the on-road vehicle fleet in the near to mid term. Currently, ICEs power more than 99% of the vehicle fleet and provide motive service to more than 240 million on-road passenger vehicles, and for the foreseeable future, most vehicles will still be ICE-powered. The recently revised Corporate Average Fuel Economy (CAFE) standards<sup>16</sup> and the upcoming more stringent emissions regulations (e.g., Tier 3 Vehicle Emission and Fuel Standards Program,<sup>17</sup> Low Emission Vehicle [LEV-III] Program<sup>18</sup>) are expected to accelerate deployment of engine efficiency improving technologies.

Current ICEs already offer outstanding drivability and reliability, still have the potential to become substantially more efficient and have the capability to use alternative fuels. Engine efficiency improvements alone can potentially increase passenger vehicle fuel economy by 35%–50%, and commercial vehicle fuel economy by 30%–40%, both compared to the baselines shown in Figure 8.4, with accompanying carbon dioxide emissions reduction.<sup>19</sup> These improvements offer direct fuel cost savings to the consumer and do not require any changes to consumer driving behavior.

Accurate simulation of fundamental in-cylinder combustion/emission-formation processes and the effects of fuel composition will enable increased engine efficiency. Advances in engine technologies, sensors, and onboard computing are enabling unprecedented opportunities in high-speed engine controls for the real-world implementations of advanced high-efficiency clean combustion strategies and improved integration with emissions controls and engine waste heat recovery.

R&D addresses the following technological barriers to the development of more efficient ICEs:<sup>20</sup>

- Inadequate understanding of fundamentals of in-cylinder combustion/emission-formation processes and inadequate capability to accurately simulate them, as well as incomplete understanding and

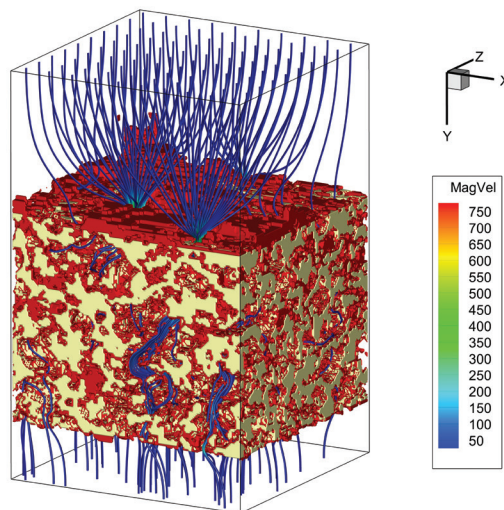
predictive capability for exploiting or accommodating the effects of fuel composition

- Lack of cost-effective emission control to meet standards for oxides of nitrogen and particulate matter emissions with a smaller penalty in fuel economy
- Incomplete fundamental understanding of, and insufficient practical experience with, new low-temperature catalyst materials and processes for lean-burn engine emission control
- Lack of integrated computational models that span engine and emission control processes with vehicle loads to predict vehicle fuel economy improvements
- Lack of effective engine controls to maintain robust and clean lean-burn combustion for boosted, down-sized engines
- Lack of understanding of issues such as energy demand, conversion efficiency, durability, and cost of new emission control systems for engines operating in novel combustion regimes that need to perform effectively for 150,000 miles in passenger vehicles and 435,000 miles for heavy-duty engines
- Higher cost of more efficient ICE technologies (advanced engines are expected to be more expensive than conventional gasoline engines and additional cost must be offset by benefits)

Research and development focuses on increasing the efficiency beyond current state-of-the-art engines and reducing engine-out emissions of  $\text{NO}_x$  and PM to near-zero levels. Research is being conducted on three major combustion strategies that have the potential to increase fuel economy in the near to mid term:<sup>21</sup> a) low-temperature combustion, including homogeneous charge compression ignition, pre-mixed charge compression ignition, and reactivity controlled compression ignition; b) lean-burn (or dilute) gasoline combustion; and c) clean-diesel combustion. In parallel, research can increase emission control system efficiency and durability to comply with emissions regulations at an acceptable cost and with reduced dependence on precious metals. Due to the low exhaust temperatures ( $150^\circ\text{C}$ ) of lean-burn engine technologies, emissions of  $\text{NO}_x$  and PM are a significant challenge. Modeling and simulation of air flow through a catalyzed soot filter (Figure 8.5) provides

understanding of the placement of the catalyst on the substrate to maximize soot removal and minimize back pressure increase.

**Figure 8.5** Catalyzed Particulate Filter Air Flow Modeling<sup>22</sup>



A critical issue for future R&D will be achieving the maximum theoretical ICE fuel conversion efficiency of about 60%, which is considerably higher than the mid-40% peak values seen today.<sup>24</sup> High irreversibility in traditional premixed or diffusion flames limits achievable efficiencies. Other contributing factors are heat losses during combustion/expansion, structural limits that constrain peak cylinder pressures, untapped exhaust energy, and mechanical friction.

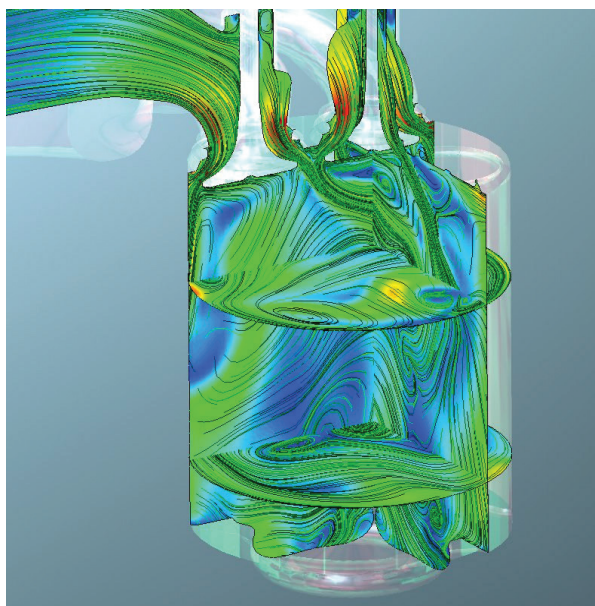
R&D opportunities include operating the engine near peak efficiency over real-world driving cycles. For spark ignition engines, this means reducing the throttling losses with technologies such as lean-burn, high-dilution, and variable compression ratio. Exhaust losses can be reduced with compound compression and expansion



cycles made possible by variable valve timing, use of turbine expanders, and regenerative heat recovery. R&D can enable engine hardware changes needed to implement advanced combustion strategies, including variable fuel injection geometries, turbo- and super-charging to produce very high manifold pressures, compound compression and expansion cycles, and improved sensors and control methods. Larger reductions in combustion irreversibilities may be possible through approaches that are a substantial departure from today's processes.<sup>25</sup>

Advancing engine technologies to improve automobile fuel economy will require industry to accelerate its product development cycles even as it explores innovative designs. Design processes that over-rely on “build and test” prototype engineering are slow. The challenge of accelerating product design and speeding up market introduction of advanced combustion engines presents a unique opportunity to marshal U.S. leadership in science-based simulation to develop new capabilities in predictive computational design, such as simulating the complex in-cylinder air flow during the intake stroke (Figure 8.6) to enhance engine performance. Predictive computational design and simulation tools will shrink engine development timescales, reduce development costs, and accelerate time to market of more efficient, emission-compliant ICEs.

**Figure 8.6** Complex In-cylinder Flow During Intake Stroke in Diesel Engine<sup>23</sup>



### 8.2.2 Fuel-Vehicle Co-optimization

Significant improvements in engine efficiency and GHG emissions are possible through co-optimization of fuels and engines that are designed in tandem to enable maximum performance. Additional GHG reductions are possible through leveraging the lowest carbon pathways to create fuels with desired properties (discussed in detail in Chapter 7). Higher compression ratios in engines can allow higher maximum efficiency, but in SI engines, compression ratios are limited by the tendency of gasoline to autoignite, or “knock.” Increasing the octane of liquid fuels would enable design of engines with higher compression ratios without experiencing knock. A high-octane fuel from a renewable source can have the additional benefit of reducing life-cycle GHG emissions. Currently, the only renewable high-octane fuel available at large scale is ethanol, which makes up 10% of gasoline sold by volume. Increasing this percentage of ethanol can dramatically increase the octane

**Table 8.3** Fuel-Vehicle Co-optimization Impact Summary (DOE calculations)

Technology system	R&D time frame	Per vehicle impacts		Long-term impact potential	
		GHG reduction	Petroleum reduction	Annual GHG reduction	Petroleum reduction
LDV combustion	2025–2030	9%–14%	Up to 30%	96–149 MMT	5.2 quads

rating of the finished gasoline/ethanol fuel blend, with most of the benefit being realized around 25%–40% ethanol by volume. Other renewable components (e.g., bio-derived isobutanol) also have high octane ratings. Higher-octane fuel would enable downsizing, downspeeding, and charge air boosting of the engine to improve the fuel economy of vehicles. Understanding what additional physical fuel properties, such as heat of vaporization, impact engine performance and how fuel with desirable properties can be produced using the lowest-carbon pathways is a key area requiring research.

Similarly, fuel properties optimal for advanced compression ignition engines (i.e., diesel engines) and advanced combustion regime engines (e.g., low temperature combustion) will be sought via renewable routes. Advanced combustion regime engines present a particular challenge because they are less well understood than conventional spark ignition and compression ignition engines. Much of the data space, including determination of desirable properties for fuels, remains to be populated. Many versions of advanced combustion exist and each has fuel property requirements associated with it that do not always match those for other versions (or current fuel specifications). As advanced combustion engines come into the market over the next few decades, we have a unique opportunity to design the performance specifications of commercially available fuels for the future to match the appetite of whatever version of advanced combustion regime engine emerges as dominant in the market.

The following technological barriers to the co-development of fuels and engines require R&D:

- A high volume of candidate fuel and an expensive and cumbersome engine-based test are currently required to compare candidate fuels to a baseline.
- The decades-old octane tests (Research Octane Number and Motor Octane Number) were designed to detect auto-ignition for petroleum-derived fuels. As bio-derived feedstocks diversify the blending streams for gasoline fuels, some of the knock-resistant fuel properties are not adequately measured (such as heat of vaporization). Moving forward, it is essential to ensure that fuel standards tests measure all of the relevant fuel properties under relevant engine conditions for current and evolving combustion regimes.
- There is a lack of information on current biochemical and thermochemical routes for biofuels, as well as a need to develop a library of pathways and proposed end products, and how these relate to and can be co-optimized with engine performance.
- There is no database of fuel properties for candidate low-carbon fuels and biofuels.

Because end-to-end, market-driven solutions are required to bring any new fuel to market, R&D should consider production, distribution, and dispensing of fuels into the retail market including required technology and infrastructure compatibility, topics that are discussed in detail in Chapter 7.

### 8.2.3 Efficient Light-Duty Vehicle Systems

A system engineering approach to more conventional powertrains can provide potential fuel savings beyond what is possible at the component level. Vehicle level attributes, accessory load management, powertrain systems optimizations, and driver feedback are areas that present opportunities to improve the system efficiency of the light-duty vehicle fleet.

Vehicle mass, aerodynamics, and rolling resistance define the energy required to move a vehicle on a given speed profile. Light weighting while maintaining crashworthiness is addressed through materials research detailed in Section 8.3. Tire technology has to balance dynamic requirements such as braking and lateral grip and provide low rolling resistance of tires to reduce the powertrain losses. Research to quantify the tires losses impact on the overall powertrain efficiency across different operating conditions (temperatures and pressures) can lead to opportunities to improve the overall powertrain efficiency. Gearing losses in the vehicle driveline (i.e., transmission, differential, constant-velocity joints, bearings) can be mitigated through research in

tribology on lubricants and surface treatment at a range of thermal conditions. Aerodynamic considerations are especially important for highway travel. Although aerodynamics and body design for vehicles are compromises in the hands of individual manufacturers, active aerodynamics devices deserve attention. Addressing these vehicle level attributes from a vehicle system perspective can result in a reduction in energy consumption.

The majority of fuel energy is translated to vehicle motion along with engine and driveline losses, but a notable amount of energy is absorbed by accessories that enable the powertrain to operate other loads, such as pumps, fans, and controllers; or provide service to the driver such as climate control, power steering, radio, and headlights. These devices may be operated through mechanical linkages to the engine. The electrification of typical mechanical components, such as fans, power steering, and pumps enables these systems to operate in optimized conditions rather than depend on engine speed. The industry has already migrated toward accessory electrification but there are still opportunities to optimize these loads. Other opportunities include advanced lighting, higher efficiency 12V (volt) power generation, and the active management of that generation (system control research).

The largest accessory load in a vehicle is related to the climate control system for the cabin, especially the air conditioning compressor. In a light-duty vehicle, five kilowatts (kW) of mechanical power (up to 30 kW of fuel power) can be consumed by the air conditioning system for initial cooling and 1–2 kW of mechanical power for temperature maintenance. The ventilation fans can also consume considerable energy. R&D can reduce the energy needed for cooling through cabin pre-conditioning (for example, ventilation before the driver gets in the car or thermal energy storage such as phase change materials), reducing heat loads on vehicles (for example, spectrally reflective windshield and window coatings to reflect near-infrared radiation), and through focused cooling on the driver rather than the whole cabin. Although conventional vehicles use waste heat for cabin heating, laboratory testing has shown that a conventional vehicle with the heater on consumed more fuel than the same vehicle with the heater off. This shows value in further powertrain and cabin thermal management research.

The efficiency technologies discussed in Section 8.2.1 enable other systems fuel saving strategies. For example, advanced combustion systems can allow deceleration fuel cut off. Idle stop technology (also called “start-stop” technology), which shuts the engine off while the vehicle is stopped, provides another avenue to save fuel in city driving. The idle stop feature utilization rate is reduced by climate control needs and cold start powertrain requirements. Further system work could regain the start stop functionality by using phase change material to maintain cool cabin air even if the compressor is off while the engine is off. The cold start operation may also be improved through thermal heat redistribution or engine thermal insulation enabling a faster warm up period.

Vehicles with a 48V electrical system (rather than a conventional 12V system) enable new fuel saving opportunities at a relatively low system cost. A 48V electrical system enables more efficient power transfer and higher power levels, allowing expanded electrification of accessories such as air conditioning. In addition, a 48V system enhances start-stop technology through faster engine restart, and creates opportunities for further efficiency through mild hybridization (e.g., electric torque addition to powertrain, engine load leveling, and regenerative braking). While electrical systems at voltages higher than 48V could increase efficiency further, they are significantly more expensive.

A research focus that has significant potential in fuel saving is at the interface between the powertrain and the driver. The driver’s driving style can influence a vehicle’s fuel consumption by up to 20%.<sup>26</sup> Therefore, methods to encourage more efficient driving behaviors can enable large fuel savings.

Much of the research addressed in this section will also translate to applications in hybrid electric vehicles (HEV) and plug-in electric vehicles (PEV). Furthermore, a smaller subset of technologies in this section could be options to improve fuel efficiency in the current legacy fleet.

### 8.2.4 Heavy-Duty Vehicle Engine and Systems

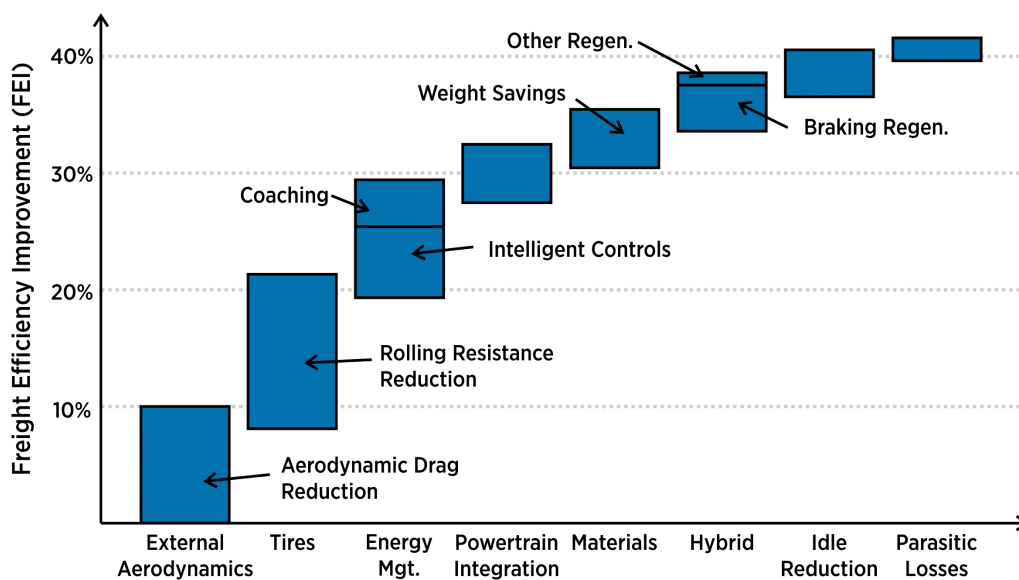
Heavy-duty vehicles, which include trucks of all classes, are a mainstay for trade, commerce, and economic growth in the United States. Long-haul Class 8 trucks represent 4% of the heavy-duty vehicles on the road but consume about 18% of the fuel used by all on-road vehicles.<sup>27</sup> Class 8 trucks, mostly diesel-powered, move 73% of freight by value, and 49% by ton-mileage of freight travel. Improving the efficiency of heavy-duty vehicles is a particularly important strategy, where drivetrain electrification is less practical in the medium term.

The modern heavy-duty vehicle is a complex and carefully designed vehicle. Complementing recent progress in key components like engines and tires, some of the most promising future efficiency gains will be attained through system synergies (i.e., the tractor-trailer combination of over-the-road, long-haul Class 8 trucks). Technology areas relevant to heavy-duty vehicles system include aerodynamics (including advanced wind tunnel testing and air flow modeling), hybridization (advanced modeling and simulation to speed development), transportation electrification (with specific applications for heavy vehicles), thermal management (climate control and efficiency solutions), friction and wear (advanced lubricants), and data collection and modeling (including real-world operational data). The systems viewpoint extends to the operation of the vehicle as well, with technology improvements to help drivers operate the vehicle more efficiently.

Energy-efficient technologies, if cost-effective, are very often adopted quickly by commercial heavy truck fleets, where profit margins are small and fuel represents the largest operating cost. Vehicles in this sector can accumulate more than 150,000 miles per year, so small percentage improvements in fuel economy can represent large annual cost savings. R&D can serve a key role in demonstrating to industry stakeholders, fleets, and the general public that real-world fuel efficiency gains can be attained with technologies that are practical and usable in customer drive cycles. In addition, the heavy truck market is now subject to federal fuel efficiency and greenhouse gas standards, the first phase of which was completed in 2011 to take effect for the 2014 to 2018

**Figure 8.7** Vehicle-level Technology Contributions to Efficiency.<sup>28</sup> Freight efficiency represents decreased energy use per ton-mile.

## Roadmap: Vehicles-Side Technologies



model years, and the second phase in 2015 for the 2021 and 2027 model years. These new standards are also driving considerable interest in fuel saving technologies, particularly in the long haul (Class 8) truck market. R&D can address technology needs in the development and deployment of system efficiency technologies into the heavy truck market.

Government-industry RDD&D collaborations have demonstrated 40%–75% gains in on-road freight efficiency of long-haul Class 8 tractor-trailer combination trucks as a function of various truck system-level combinations of advanced engine packages, waste heat recovery, improved lubrication, advanced transmissions, aerodynamics, predictive cruise control, lithium-ion battery auxiliary power for idle management and/or a parallel hybrid system, low rolling resistance tires, and lightweight materials. For an example, see Figure 8.7.

Due to increased availability of natural gas, significant new interest has focused on using natural gas in heavy trucks. In current vehicles, use of natural gas in either a spark-ignition engine or mixed with diesel in a bi-fuel engine decreases efficiency. R&D in a purpose-designed engine optimized around natural gas could potentially reduce that efficiency gap. Natural gas vehicles generally produce lower emissions of hydrocarbons, carbon monoxide, and particulate matter than analogous diesel vehicles, but higher emissions of nitrogen oxides. Newer natural gas engines, however, operate at higher fuel/air ratios with water-cooled exhaust recirculation and a three-way catalyst to reduce NO<sub>x</sub> emissions.<sup>29</sup>

Vehicle systems R&D, using a combination of simulation, lab testing, and real-world operations, develops system-level solutions and evaluates their performance, efficiency, costs, and benefits. Heavy-duty engines and vehicle systems have made great advances in the state-of-the-art for the Class 8 truck market, but still may be difficult to commercialize due to policy or regulatory issues. For example, some aerodynamic technologies may affect the operation of safety-critical systems such as lighting or rear under-ride guards on trailers.

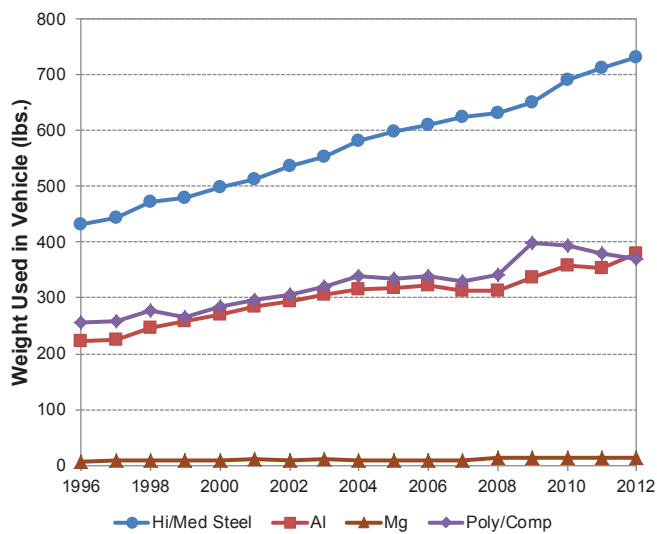
### 8.3 Lightweighting

Reducing the vehicle weight can significantly reduce a vehicle’s fuel consumption at all vehicle speeds by reducing rolling resistance and power required for acceleration. For vehicles using conventional internal combustion engines, a 10% reduction in vehicle weight will improve fuel economy between 6% and 8%<sup>30</sup> when the vehicle systems, including the engine, are resized to maintain equal performance. Comparable savings in vehicle energy demand with weight reduction occur in all vehicle classes. For example, reducing the weight of heavy-duty vehicles improves both fuel and freight efficiency. Table 8.4 outlines the integrated impacts from the technologies in this section if successfully deployed fleet wide.

**Table 8.4** Fuel-vehicle Co-optimization Impact Summary (DOE calculations)

Technology system	R&D time frame	Per vehicle impacts		Long-term impact potential	
		GHG reduction	Petroleum reduction	Annual GHG reduction	Petroleum reduction
Lightweighting	to 2019	20%	20%	213 MMT	3.4 quads

Today’s average passenger vehicle weighs 3,350 pounds without passengers or cargo, and consists of the following materials as a percentage of total vehicle mass: 54% iron or mild steel; 10% first generation high-strength steel; 9% aluminum; 7% plastic; 4% glass; 1% magnesium; and the remaining 15% a mixture of copper, paint, carpeting, padding, insulation, and rubber. The amount of high-strength steel, aluminum, plastic, and magnesium has been steadily increasing, as shown in Figure 8.8. Since 1996, lighter-weight materials have shown significant increased use in production vehicles. Aluminum has increased by 70%, magnesium has increased by 64%, medium- and high-strength steel has increased by 70%, and the use of composites

**Figure 8.8** Trends of Lightweight Materials Use in Vehicles<sup>31</sup>

has increased by 45%. In today's car, the use of these materials represents a 10% weight reduction and a 7% improvement in fuel economy.

Despite this increased use of lightweight materials, vehicle weight increased throughout this period until 2004, probably due to offsetting weight increases from other content changes, such as increased safety system requirements, increased vehicle size, greater consumer content (such as entertainment, speakers, etc.), and higher-output drivetrains.

There are a number of new materials under development that may have application in vehicle lightweighting—if technical, performance, manufacturing, and cost improvements can be achieved. These materials include next generation high-strength steel (sheet), high-performance cast steel/iron, sheet magnesium, high-performance cast magnesium, high-performance cast aluminum, low-cost automotive grade carbon fiber, hybrid carbon/

**Table 8.5** Materials Properties, Cost, and Lightweighting Potential Relative to Mild Steel<sup>32</sup>

Material	Density (g/cm <sup>3</sup> )	Comparison to steel			
		Strength/density	Modulus/density	Cost	Mass reduction potential
Mild steel	7.87	1	1	1	0%
High-strength steel	7.87	1.86	1	0.9–1.2	10%
Adv high-strength steel	7.87	3	1	0.8–1.5	10%–28%
Gen 3 high-strength steel	7.87	7	1	1.0–2.0	15%–30%
Ceramics	3.9	0.7	3.05	1.5–3.0	10%–30%
Sheet molding compound	1.1–1.9	4.39	1.16	0.5–1.5	20%–30%
Glass fiber composites	1.4–2.4	4.74	5.75	0.9–1.5	25%–35%
Plastics	0.9–1.5	0.82	0.08	0.7–3.0	20%–50%
Aluminum	2.7	3.95	1.02	1.3–2.0	30%–60%
Titanium	4.51	4.73	0.98	1.5–10	40%–55%
Metal matrix composites	1.9–2.7	5.41	35.28	1.5–3.0	50%–65%
Magnesium	1.74	3.66	1.02	1.5–2.5	30%–70%
Carbon fiber composites	1.0–1.6	20.9	5.41	1.5–5.0	50%–70%

glass fiber composites, and low-cost titanium. Most of these new materials are being tailored to automotive requirements and have cost targets up to 50% less than commercially available aircraft grade materials, as shown in Table 8.5. Still, cost of the base material remains a challenge.

Quantifying vehicle-level weight reduction potential is complex because the answers will vary with vehicle platform, performance requirements, and commercial limitations in the supply chain and manufacturing infrastructure. While weight reduction through material substitution is a promising pathway for body and structure and chassis components, Table 8.6 indicates that about 32% of vehicle weight is due to non-structural systems such as the powertrain, heating, ventilation, and air conditioning (HVAC), and electrical.

**Table 8.6** Vehicle Weight in a Typical Mid-size Passenger Car Without Passengers or Cargo. Weight is distributed across different subsystems in the vehicle (DOE calculations)

System	Baseline weight (lbs.)	Percent of total
Body and structure	1,591	47%
Chassis	696	21%
Powertrain	645	19%
HVAC and electrical	158	5%
Other	268	8%
<b>Total</b>	<b>3,358</b>	

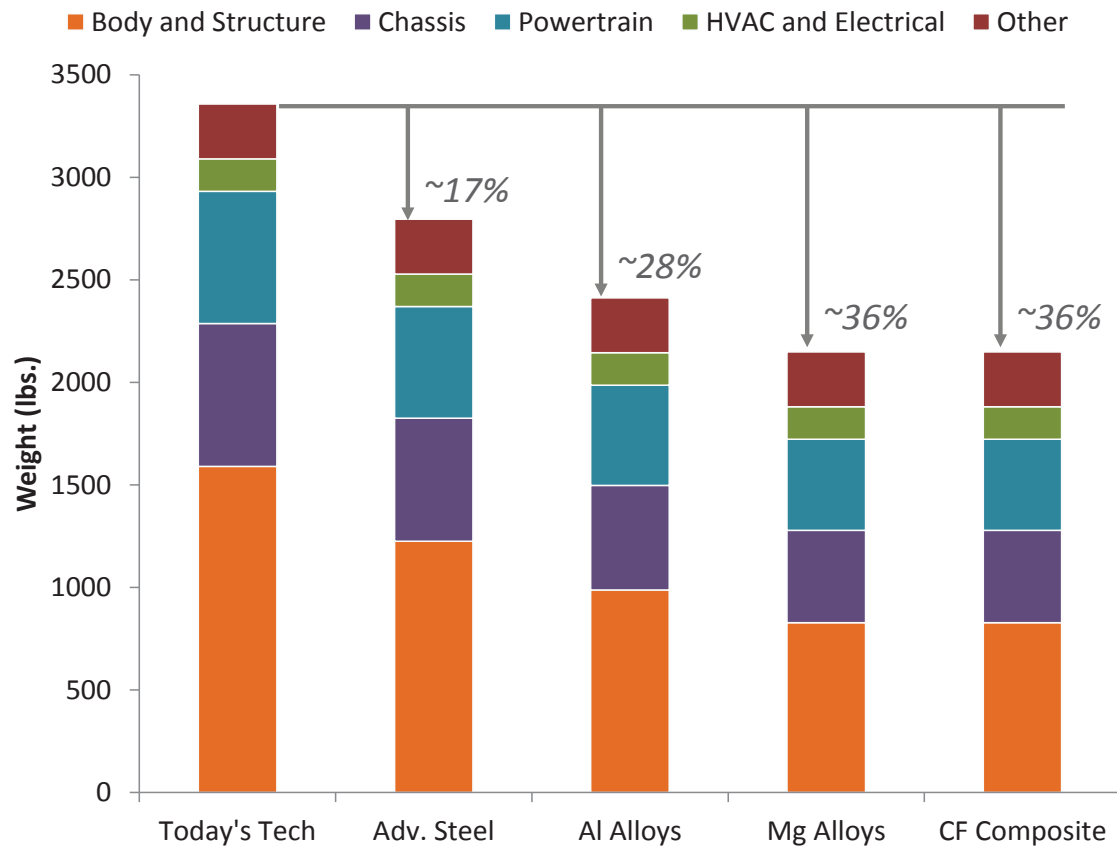
Weight reduction in the powertrain and in certain parts of the chassis is achieved mostly through mass decompounding—for example, by reducing the size of the engine and brakes to accommodate a lighter-body structure—rather than through direct savings. Finally, the weight reduction potential for many systems, such as the HVAC or many electrical components, is negligible. The weight reduction potentials for vehicles that make the greatest reasonable use of each material system discussed here are shown in Figure 8.9.

R&D has focused on developing these most promising materials and the technology needed to overcome barriers to use in automotive structural applications, while continuing to evaluate other material options as new information becomes available. These research and development activities can be partitioned into three broad areas:

- **Properties and manufacturing:** Reducing the cost of raw materials and processing, while improving the performance and manufacturability.
- **Multimaterial enabling:** Evaluation and development of multimaterial joints and structures, taking best advantage of the properties of each of the materials.
- **Modeling and simulation:** The development of commercially available design tools and predictive models, which incorporate validated data and computational processes for lightweight material options, and making the validation data available to the community.

Lightweight materials also face non-technical considerations from consumers, manufacturers, and suppliers. From the consumer perspective, substituting lighter-weight materials for steel in vehicle structures can increase production cost and vehicle price. From the manufacturer’s perspective, vehicle weight reduction involves risk, such as uncertainty in structural performance and repair concerns. While there are supply chain capacity concerns with the lighter-weight material options, material supply is of particular concern with magnesium and carbon fiber, where minor increases in use of these materials across a wide section of the automobile fleet would overwhelm the current available supply.

**Figure 8.9** Weight Reduction Opportunities if the Indicated Material was Applied to the Greatest Extent Possible. Each bar is the weight allocation after replacement with advanced materials. Percentage reductions are shown for the whole vehicle (DOE calculations).



## 8.4 Plug-in Electric Vehicles

PEVs draw their energy partially or entirely from an external electric source by storing the energy in an on-board battery and using that energy to run the vehicle on electric motors. In plug-in hybrid electric vehicles (PHEV), the battery provides the primary power source for a number of “all-electric” miles, after which the vehicles operate in HEV mode. The inherent efficiency of electric drive and recapture of braking energy allows very high vehicle efficiencies. Additionally, electricity in the United States uses almost no petroleum and can be significantly decarbonized (see Chapter 4); as such, shifting mobile sources like vehicles to electricity can provide large GHG and petroleum reductions. Electrification is most viable in the light-duty vehicle fleet, as onboard energy storage becomes an increasing challenge with higher power and total energy storage requirements. Opportunities in this section include improved batteries, better electric drive technologies, and systems-level research. The overarching technical goals are to achieve PEV cost parity with conventional vehicles for a wide variety of consumers. Table 8.7 outlines the integrated impacts from the technologies in this section if successfully deployed fleet wide.

### 8.4.1 Batteries

An important step for the electrification of the nation’s light duty transportation sector is the development of more cost-effective, long-lasting, and abuse-tolerant batteries. Lower-cost, abuse-tolerant batteries with higher energy density, higher power, better low-temperature operation, and longer lifetimes are needed for



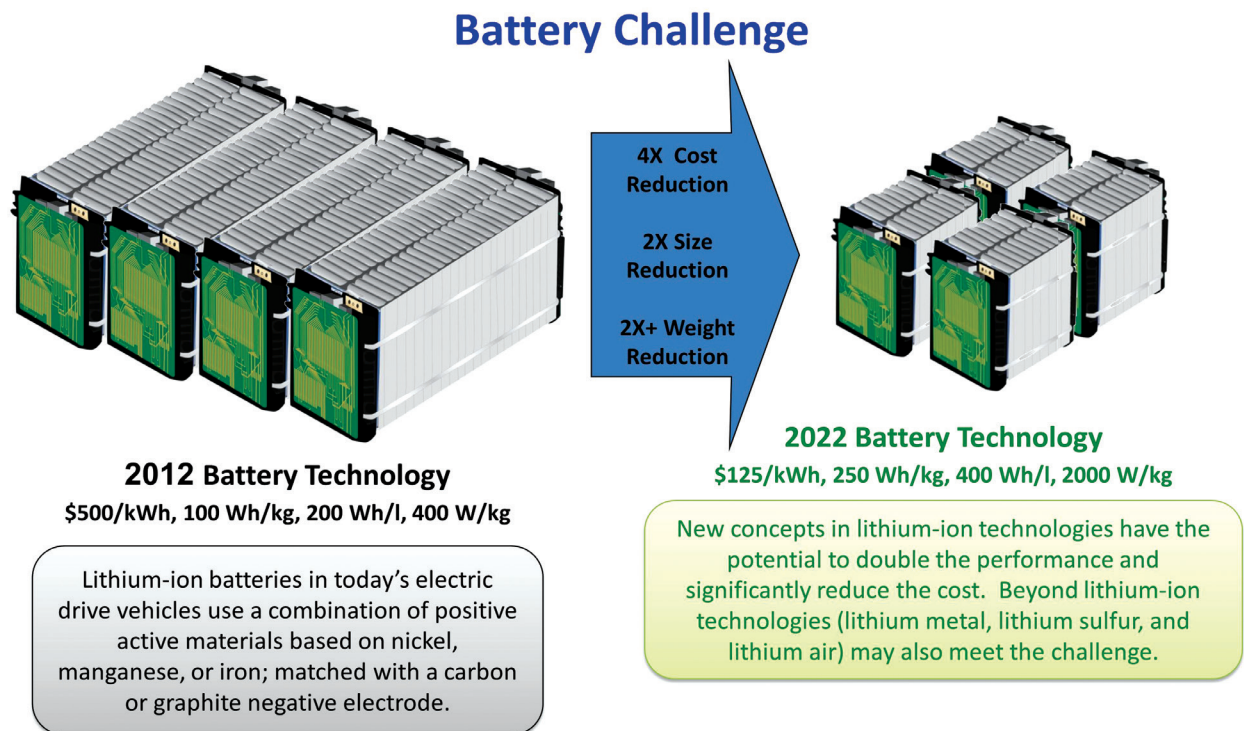
**Table 8.7** Plug-in Electric Vehicle Impact Summary (DOE calculations)

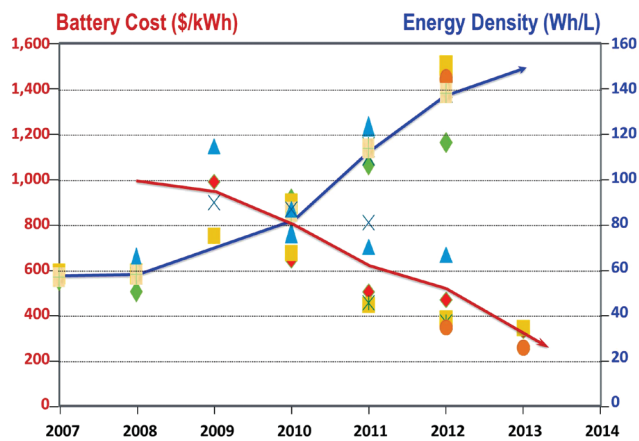
Technology system	R&D time frame	Per vehicle impacts		Long-term impact potential	
		GHG reduction	Petroleum reduction	Annual GHG reduction	Petroleum reduction
PEVs	To 2022	Up to 80%	Up to 99%	852 million metric tons	17 quads

the development of the next-generation of HEVs, PHEVs, and electric vehicles (EV) to expand commercial markets. Lithium-based batteries offer the potential to meet the requirements of all three applications, and ultra-capacitors may offer a more cost-effective solution for low-energy, high-power micro- and start/stop HEVs. Technology projections and market analysis show that more cost-effective, longer-lasting, and more abuse-tolerant PEV batteries are necessary for enabling PEVs to be as convenient and affordable as today's gasoline vehicles by 2022, as shown in Figure 8.10.

R&D efforts, including pack design optimization and simplification, manufacturing improvements at the cell and pack level, materials production cost reduction, and novel thermal management technologies, can also contribute to battery cost reduction. Achieving the battery power density target (2,000 watts per kilogram) is important to assure that technology breakthroughs meet the discharge power requirements for a wide range of PEV architectures and to enable the battery to be rapidly charged. Fast charging may be important for consumer adoption of certain PEVs. Battery R&D includes research to reduce cost, weight, and volume, improve performance, efficiency and reliability, develop innovative modular and scalable designs, improve manufacturability, and accelerate commercialization.

**Figure 8.10** Battery Performance Advancements that are Needed to Enable a Large Market Penetration of PEVs<sup>33</sup>



**Figure 8.11** Modeled Cost and Energy Density of PEV Batteries Developed and Tested<sup>35</sup>

R&D has made significant progress, reducing the cost of lithium-ion batteries by nearly 70% and improved their energy density by 60% during the last five years. As shown in Figure 8.11, the modeled cost of PHEV batteries under development has been reduced from \$1,000 per kilowatt-hour (kWh) of useable energy in 2008, to a cost of \$289 per kilowatt-hour in 2014 if mass produced at the rate of 100,000 units per year. Market prices have also fallen significantly.<sup>34</sup> Battery development projects focus on

advanced cathodes, processing improvements, cell design, and pack optimization, using standard electrolytes and graphite anodes.

Concurrently, the size and weight of PEV battery packs have also been reduced by more than 60%. The battery pack energy density has increased from 60 watt-hours (Wh) per liter in 2008, to more than 150 Wh/liter in 2014.

Despite recent progress, current battery technology is still far from its theoretical energy density limit. In the next roughly five years, advances in lithium-ion technology could more than double the battery pack energy density from 120 Wh per kilogram to 250 Wh per kilogram through the use of new high-capacity cathode materials, higher voltage electrolytes, and the use of high-capacity silicon or tin-based intermetallic alloys to replace graphite anodes.<sup>36</sup>

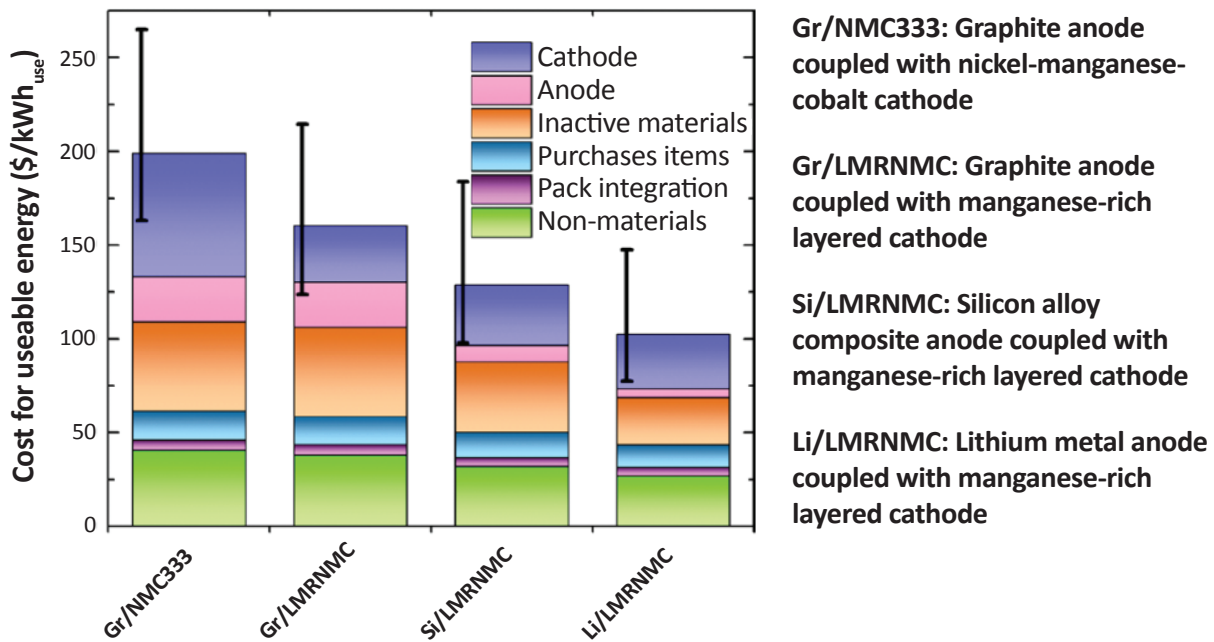
In the next five to fifteen years, “beyond Li-ion” battery chemistries, such as lithium-sulfur, magnesium-ion, zinc-air, and lithium-air, offer the possibility of energy densities that are significantly greater than current lithium-ion batteries, as well as the potential for greatly reduced battery cost.<sup>37</sup> However, major shortcomings in cycle life, power density, energy efficiency, and/or other critical performance parameters currently stand in the way of commercial introduction of state-of-the-art “beyond Li-ion” battery systems. Breakthrough innovation will be required for these new battery technologies to enter the PEV market.

The potential of more advanced lithium-ion materials and “beyond lithium-ion” chemistries to reach the goals has been quantified using the Battery Performance and Cost model developed at Argonne National Laboratory.<sup>38</sup> This model captures the interplay between design, performance, and cost of advanced battery technology. The results show that the combination of lithium- and manganese-rich high-energy cathode (LMRNC) and silicon alloy anodes can significantly improve battery costs. Batteries with silicon alloy anodes (Si/LMRNC) and lithium metal batteries (Li/LMRNC) are estimated to be able to reach a cost of \$125/kWh, as shown in Figure 8.12.

R&D can help overcome the major challenges to developing and commercializing batteries for PEVs:

- Cost:** Primary battery cost drivers are the high cost of raw materials and materials processing, the cost of cell and module packaging, and manufacturing costs. Addressing the cost barrier requires developing and evaluating lower-cost components, including much higher energy active materials, alternate packaging, and processing methods, as well as joint work with U.S. suppliers to implement these low-cost solutions.

Figure 8.12 Advanced Battery Technology Low-cost Pathway<sup>39</sup>



Estimated cost for a 100 kWh use PEV battery using advanced technology and produced at 100,000 packs per year. (Courtesy of Argonne National Laboratory, Joint Center for Energy Storage Research, supported by DOE Office of Science, Basic Energy Sciences.)

- Performance:** Higher energy densities are needed to meet both volume and weight targets for PHEV and EV applications, and improvements in low-temperature performance are particularly critical when the battery is the sole power source.
- Abuse tolerance, reliability, and ruggedness:** Many lithium batteries are not intrinsically tolerant of certain abusive conditions that can occur during vehicle operation, particularly large format lithium cells. In addition, current thermal control technologies, although adequate to dissipate heat in today's systems, are expensive and add significant weight and volume.
- Life:** For high-energy batteries in a PEV application, a combination of energy and power fade over life are challenging issues as the battery must provide significant energy over the life of the vehicle and either provide full vehicle power (for an EV) or high-power HEV pulses (for a PHEV) near the bottom of its state-of-charge window. Today, batteries designed for HEVs can deliver 300,000 shallow discharges. However, batteries with a higher energy density have difficulty meeting the 5,000 deep discharge cycle requirement for PHEVs.

Battery technology R&D includes multiple activities, from focused fundamental materials research, generally spearheaded by the national laboratories and universities, to battery cell and pack development and testing, mainly by commercial developers and national laboratories.

## Joint Center for Energy Storage Research

### *The Batteries and Energy Storage Hub: Beyond Lithium-ion for Next-generation Energy Storage Technologies*

The Joint Center for Energy Storage Research (JCESR), headquartered at Argonne National Laboratory and managed by the DOE Office of Basic Energy Sciences (BES), brings together many of the world's leading battery researchers around a common objective of overcoming fundamental scientific challenges and enabling next-generation, beyond lithium-ion, energy storage systems for both transportation and the electrical grid. Funded at approximately \$120 million over five years, the JCESR mission is to pursue advanced scientific research to understand electrochemical materials and phenomena at the atomic and molecular scale, and to use this fundamental knowledge to discover and design new approaches for next-generation energy storage. The enhanced understanding of materials and chemical processes at a fundamental level will enable exploration of new technologies. The overarching goal of JCESR is, within five years, to produce prototypes for both transportation and grid-level storage that will scale up to store at least five times more energy than the baseline 2011 batteries at one-fifth of the cost. JCESR is coordinating its efforts with the DOE BES Energy Frontier Research Centers and DOE technology offices including the Office of Energy Efficiency & Renewable Energy (EERE), the Office of Electricity Delivery and Energy Reliability (OE) and the Advanced Research Projects Agency - Energy (ARPA-E). JCESR's industrial partners help guide the Hub's efforts to ensure that the research leads toward practical solutions that are competitive in marketplaces such as transportation, electric utilities, construction, electronics, medicine, aerospace, and defense.



JCESR focuses exclusively on beyond lithium-ion batteries, a wide, rich and relatively unexplored research space. JCESR carries out its research through collaborative teams that span discovery science, battery design, research prototyping, and manufacturing collaboration; these teams interact across the R&D spectrum. The effort is organized around three broad research directions, each containing multiple battery chemistries: multivalent intercalation, chemical transformation, and non-aqueous redox flow. In addition, computational chemistry research is introducing a genomic approach to evaluate thousands of materials by theory and computer modeling before selecting the most promising candidates for laboratory synthesis. For materials characterization, JCESR is leveraging the unique capabilities of the DOE laboratory system to explore structure-function relationships at the atomic and molecular level. For systems-level assessments, techno-economic modeling translates these materials discoveries to systems level operation, projecting the performance and cost of candidate battery systems before they are prototyped.

## 8.4.2 Electric Drive Technologies

Electric drive technologies (EDT), encompassing power electronics and electric motors (see Figure 8.13; EDT components are in green), are critical components for electric drive vehicles. Power electronics, traction motor(s), and controls add several thousand dollars to the vehicle cost. Without innovation and cost reduction in these additional components, the cost of electric vehicles will continue to exceed that of conventional vehicles.

EDT R&D opportunities are based on several key system needs:

- Reducing cost, weight, and volume
- Improving performance, efficiency, and reliability
- Developing innovative modular and scalable designs
- Improving manufacturability and accelerating commercialization

Specific opportunities for cost reduction and performance improvement lie in the following research areas:

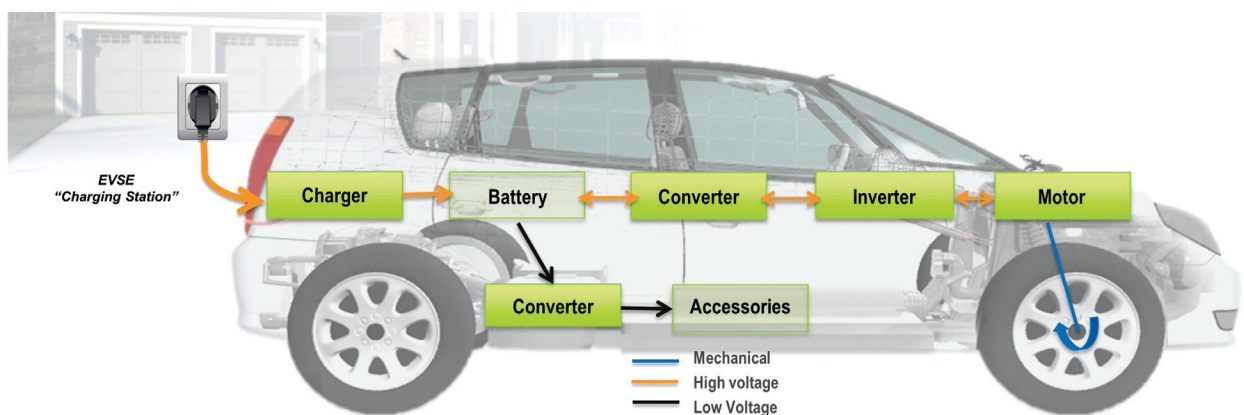
- Wide bandgap (WBG) devices for power electronics
- Advanced motor designs to reduce or eliminate rare earth materials
- Novel packaging for power electronics and electric motors
- Improvements in thermal management and reliability
- Integration of power electronics functions

Four key metrics for opportunities to improve the traction drive system (combined power electronics and motors) are cost, power density, specific power, and efficiency. EDT R&D opportunities have been identified in four different research areas: power electronics; motors; packaging technologies and design; and benchmarking, testing, and analysis. Packaging technologies and design, and benchmarking, testing, and analysis are supporting activities to electric motors and power electronics R&D. Therefore, they are included in the more detailed description of these two research areas below.

### Power Electronics

EDT research activity in power electronics primarily focuses on improving inverters, as they have the biggest impact on power electronic targets. Researchers are working to reduce inverter volume by a third, reduce part count by integrating functionality, and reduce cost. Today's vehicle power electronics utilize silicon-based

**Figure 8.13** Schematic Diagram of a PEV



semiconductors. However, WBG semiconductors are more efficient and can withstand higher temperatures than silicon components and have a significant potential to improve EDT performance, but need further research.<sup>40</sup> The two most commonly used WBG materials are silicon carbide (SiC) and gallium nitride (GaN). The ability to operate at higher temperatures can also decrease system costs by reducing thermal management requirements.

Achieving the identified improvement opportunities for power electronics will require achieving advances in several areas, including device packaging, innovative power module designs, high-temperature capacitors, and new inverter architectures. Device packaging and innovative power module designs can eliminate existing interface layers and provide cooling at or very near the heat sources. Improved capacitors can reduce inverter cost and volume, and enable higher-temperature operation. New inverter architectures can reduce part counts and enable modular, scalable components.

### Electric Motors

EDT research activity is supporting research to improve electric motors, with a particular focus on reducing the use of rare earth materials inside the rotor magnet since the magnets account for the largest portion of the motor costs and their supply is limited.<sup>41</sup> This activity's primary goal is to decrease the electric motor's cost, volume, and weight while maintaining or increasing performance, efficiency, and reliability.

### 8.4.3 Electrified Vehicles Systems

Electric-drive vehicle systems are complex and involve many technologies. Various opportunities for system integration exist among batteries, electric-drive technologies, the powertrain, and passenger's cabin experience (including electrically powered amenities). A more integrated hardware and software approach could yield better overall system efficiencies. The high operating efficiencies of electric drive powertrains increase the need for a vehicle system optimization. Reducing system losses (i.e., friction losses, tire rolling resistance, auxiliary loads), enhancing performances of components (i.e., battery capacity, electric drive efficiencies) and optimizing the vehicle characteristics (i.e., lightweighting, aerodynamics) has proportionately greater benefits for electric drive vehicles than conventional technology vehicles. PHEVs offer special opportunity for systems optimization, since the presence of both mechanical and electrical powertrains offers trade-offs between fuel and electricity, both for mobility and for other aspects of the driving experience (i.e., warming up the powertrain and cabin at freezing temperatures).

Optimizing the balance across technologies within electric-drive vehicles is an opportunity and a challenge. A key research opportunity is the system level tradeoffs between electric-drive system components. For example, a larger battery capacity increases the electric range but increases cost, mass, and packaging complexity. Hardware experiments and software tools can quantify these powertrain trade-offs and opportunities. The possible combinations of powertrain architectures are abundant and the control opportunities are substantial.

Minimizing accessory loads (powertrain support systems, climate control system, driver comfort features) are also a primary research area. For example, a small, all-electric range vehicle may use an average of 4–5 kW to move in the urban driving while an electric heater draws 4–5 kW to warm the cabin in freezing temperatures, which translates to half the electric range. Even smaller loads such as headlights or fans can affect the electric range significantly. Therefore, vehicle system R&D targets ways to minimize the system loads and increase the system efficiencies.

PEV charging interactions with the grid is another key system opportunity because charging convenience and reliability are essential enablers for PEVs. Home charging and work place charging will cover most daily use cases, but further research to understand charging behaviors is important.<sup>42</sup> Ensuring that any PEV can be charged at any charging station will require development of codes and standards related to charging, which

address the physical interfaces, power flow, communications, test procedures, and installation and permitting processes. Vehicle systems R&D includes several level of charging speeds and efficiencies up to direct current fast charging and future wireless charging technologies. The battery capacity of PEVs can also provide grid services, which are discussed in Chapter 3.

Advanced vehicle testing generates data necessary to identify research opportunities to improve vehicle technologies and systems. This includes fleet testing as well as laboratory testing of the newest powertrains, ranging from prototypes to production vehicles. The data serve to develop and validate modeling and simulation software, which itself enables a fast and methodical exploration of the design space and its potential opportunities. Testing can identify surprising systems benefits; for example, Chevrolet Volt owners thus far drive more than 70% of their daily miles on electricity,<sup>43</sup> higher than theoretical estimates using standard methodologies based on vehicle characteristics and assumptions of driving behavior (defined by standards SAE J1711 and SAE J2841).<sup>44</sup>

Vehicle system R&D can help integrate other technology progress to accelerate market penetration of advanced vehicles and systems with several objectives:

- Evaluate technology performance targets of components and systems
- Accelerate efficient designs via tools, analysis, and procedures
- Provide stakeholders with data and analysis on vehicle performance and consumer behavior to support decision making on future R&D priorities
- Accelerate codes and standards development for electric vehicles

Specific R&D opportunities to address these objectives include the following:

- Rapid evaluation of new powertrain/propulsion technologies through virtual design and analysis in a math-based simulation environment
- Laboratory and field evaluations of automotive technologies to benchmark automotive technology progress (e.g., using structured and repeatable testing methods in both laboratory and real-world fleet testing to provide unbiased, independent, public, quality data on advanced technologies; quantifying performance targets; and developing and validating simulation models)
- Research to enable informed decision making to support the development and adoption of PEV codes and standards, including communications, interoperability, security, safety, and performance of PEVs and electric vehicle supply equipment
- Investigating systems optimization strategies to enhance vehicle efficiency, robustness, and emissions performance, such as aerodynamic drag reduction, friction and wear reduction, thermal control and auxiliary load reduction, fast wireless charging, and smart grid integration

## 8.5 Hydrogen Fuel Cell Vehicles

Fuel cell electric vehicles (FCEVs) are powered by hydrogen through use of a fuel cell, which generates electricity by converting hydrogen and atmospheric oxygen to water. FCEVs are thus hybrid electric vehicles and have much in common with other electric drivetrain technologies, including motors, batteries, and regenerative braking. FCEVs can be refueled in a few minutes, can be used for a wide range of vehicle sizes and performance requirements, and can achieve a driving range of more than 300 miles. FCEVs offer large potential petroleum reductions and, especially when fueled with hydrogen from low-carbon sources, greenhouse gas reductions. Table 8.8 outlines the integrated impacts from the technologies in this section if successfully deployed fleet wide.

**Table 8.8** Fuel Cell Electric Vehicle Impact Summary (DOE calculations)

Technology system	R&D time frame	Per vehicle impacts		Long-term impact potential	
		GHG reduction	Petroleum reduction	Annual GHG reduction	Petroleum reduction
FCEVs	2020+	More than 80%	Up to 99%	>1,000 MMT	17 quads

This section addresses only the technologies specific to FCEVs, but advances in batteries and electric drive technologies can be beneficial to FCEVs as well. While using renewables to generate hydrogen can result in more than 80% reductions in total well-to-wheels carbon emissions compared to today's internal combustion gasoline vehicle, using natural gas-derived hydrogen—the dominant method today, without carbon sequestration—can yield a 50% reduction in carbon emissions compared to today's gasoline vehicle baseline.<sup>45</sup> The opportunities and challenges related to hydrogen production and infrastructure are discussed in detail in Chapter 7.

Although hydrogen and fuel cells face technological, economic, and institutional challenges, FCEVs have significant long-term potential. R&D has already reduced automotive fuel cell cost from \$124/kW in 2006 to \$55/kW today, based on high-volume manufacturing projections.<sup>46</sup> Nevertheless, further progress is needed for significant market penetration and R&D is required to address the following:

- **Cost:** Automotive fuel cell systems must cost \$30/kW or less (\$40/kW by 2020) to be competitive with gasoline internal combustion engines.
- **Efficiency and durability:** Fuel cell systems should operate at 65% efficiency (ultimate target is 70%) and be durable for 5,000 hours (equivalent to about 150,000 miles).<sup>47</sup>
- **Hydrogen storage:** On-board hydrogen storage should provide a driving range of more than 300 miles at a cost of \$8/kWh or less, without reducing performance or interior space.

### 8.5.1 Fuel Cells

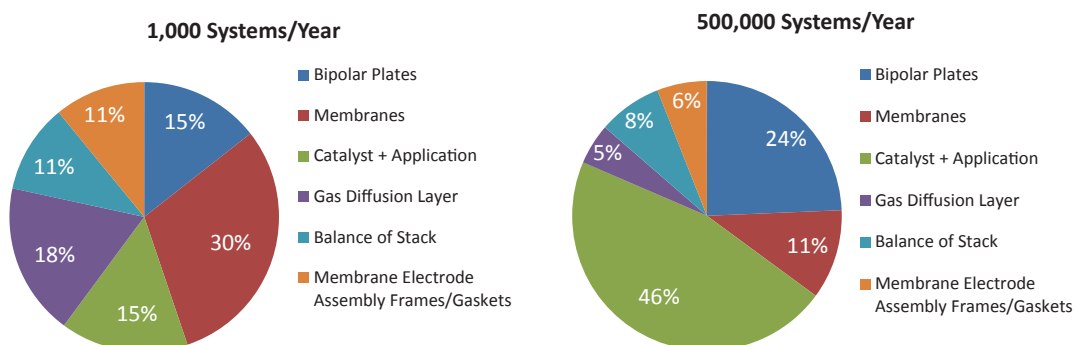
Fuel cells<sup>48</sup> convert the chemical energy in fuels such as hydrogen directly into electricity. Unlike heat engines, which are limited by Carnot efficiency, fuel cells can theoretically achieve efficiency over 90%. Current fuel cell technology can exceed 60% efficiency, and R&D is underway to reach 70% efficiency or higher. When using hydrogen as a fuel, fuel cells emit only water.

Fuel cell technology has matured enough that initial commercialization of fuel cell vehicles is already underway, but several technological barriers remain that impede commercialization and require research:<sup>49</sup>

- **Cost:** Primary fuel cell costs are a result of the high costs of materials and components as well as manufacturing processes (see Figure 8.14). Addressing the cost barrier requires developing lower-cost components such as catalysts and membranes, as well as manufacturing methods.
- **Performance:** Higher performance enables production of power at a higher efficiency from a smaller fuel cell system, leading directly to cost reductions and improved fuel economy. This implies overcoming the following barriers:
  - Sub-optimal utilization of platinum group metals (PGM) content in current catalysts
  - Low performance of current catalysts and electrodes, which require pressurized operation to achieve sufficient power output
  - Low performance of membranes under the hot and dry conditions that occur when operating near the peak power point without humidification
  - Lack of understanding of the role of electrode composition and microstructure on fuel cell performance and durability



**Figure 8.14** Breakdown of the 2014 Projected Fuel Cell Stack Cost at 1,000 and 500,000 Systems Per Year<sup>50</sup>



- **Durability:** Fuel cell systems must perform adequately more than 5,000 hours of vehicle operation, which requires overcoming the following barriers:
  - Low durability of current catalysts and electrodes, which are not yet capable of 5,000 hours of durable operation at low PGM loading
  - Low durability of current ultrathin membranes, which are not yet capable of withstanding 5,000 hours of operation with humidity cycling and exposure to contaminants
  - Tolerance of fuel cells to a range of fuel quality conditions as well as automotive cycling such as start-stop conditions

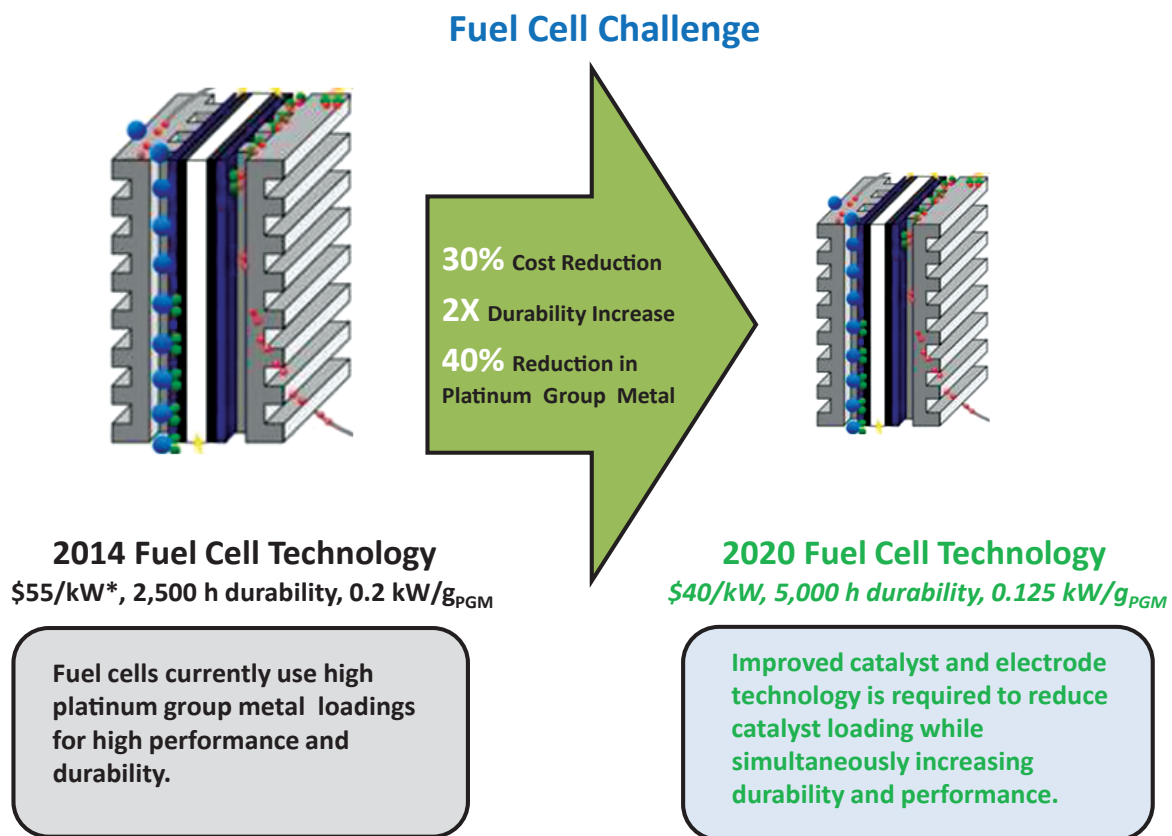
R&D on materials, stack components, balance-of-plant subsystems, and integrated fuel cell systems, with an emphasis on science and engineering at the cell level could help overcome these barriers. Additional fuel cell innovations will be required to meet cost and durability targets, including development of low-cost, corrosion-resistant metal bipolar plates and development of durable, low-cost balance-of-plant components. Figure 8.15 summarizes major advancements that would enable significant market penetration.

Specific technical targets are shown in Table 8.9 for automotive fuel cells. Some targets have already been met individually, but all targets should be met simultaneously by a single system to enable full market penetration.

While significant progress is being made and the catalyst-specific power of fuel cells was improved to 6.0 kW per gram of PGM<sup>53</sup> in 2013 (more than double the 2008 baseline of 2.8 kW/g<sub>PGM</sub>), continued R&D is needed to achieve the 2020 target of 8.0 kW/g<sub>PGM</sub>. Reductions in catalyst loading typically cause a loss of durability, increasing the challenge of reaching the 8.0 kW/g<sub>PGM</sub> target while simultaneously increasing durability to 5,000 hours. While near-term R&D focuses on PGM-based catalysts as the only viable catalysts for initial commercialization, R&D is also needed for the development of next-generation non-PGM catalysts and membrane electrode assemblies through the application of high-performance computing, high-throughput combinatorial approaches and advanced modeling. Furthermore, longer-term technologies (e.g., anion-exchange [alkaline] membrane fuel cells) could be explored to enable transformative changes in fuel cell technology, such as commercialization of fuel cells that are completely PGM-free.

### 8.5.2 Hydrogen Storage

The current near-term technology for onboard automotive hydrogen storage is focused on 350 bar (for fuel cell buses) and 700 bar (for fuel cell cars) nominal working-pressure compressed vessels (tanks). Compressed gas storage systems have been demonstrated in hundreds of prototype fuel cell vehicles and are commercially available at low production volumes. The tanks within these systems have been certified worldwide. The high-

**Figure 8.15** Fuel Cell Performance Advancements Needed to Enable a Large Market Penetration of FCEVs<sup>51</sup>

\*\$55/kW at 500,000/yr, \$280/kW at low volumes

**Table 8.9** Status and Targets for Automotive Fuel Cell System<sup>52</sup>

Characteristic	2014 status	2020 target	Ultimate target
Peak energy efficiency	60%	65%	70%
System power density	640 W/L	650 W/L	850 W/L
System specific power	659 W/kg	650 W/kg	650 W/kg
Catalyst specific power	6.0 kW/g <sub>PGM</sub>	8.0 kW/g <sub>PGM</sub>	(a)
Cost	\$55/kW	\$40/kW	\$30/kW
Durability with cycling	2,500 hours	5,000 hours	5,000 hours

(a) Current assessment is that greater than 8.0 kW/g<sub>PGM</sub> may be needed to meet the ultimate cost target

pressure hydrogen storage tanks for LDVs consist of either a metallic (Type III) or non-metallic liner (Type IV) overwrapped with a carbon fiber reinforced composite. To provide a 300-mile driving range for LDVs, current cost projections for a 700-bar Type IV system are approximately \$2,800 (\$17/kWh) if manufactured at 500,000 systems per year, but approximately \$5,500 (\$33/kWh) if manufactured at only 10,000 systems per year.<sup>54</sup> Additionally the system would require a volume roughly three to four times that of typical gasoline tanks. While automakers have demonstrated these systems can offer a driving range close to 300 miles, this cannot be accomplished across the full range of vehicle platforms at acceptable costs.

In order to provide at least a 300-mile driving range across all vehicle platforms—while not reducing passenger and cargo space—R&D is needed to enable cost reductions and advanced technologies with higher energy density. Table 8.10 lists cost, specific energy (kWh/kg) and energy density (kWh/L) targets for onboard hydrogen storage systems. These targets were developed in conjunction with vehicle manufacturers to be able to meet vehicle performance across the range of LDV platforms. Additionally, the current projected status of several hydrogen storage technologies is provided in Table 8.9. For near-term compressed hydrogen storage tanks, the key technological challenge is to reduce the cost while meeting safety and performance requirements. Additional R&D could focus on conformable tank designs that can be more efficiently packaged onboard LDVs. For the long-term, R&D efforts are required for successful development of advanced technologies that have potential to increase the energy density, and therefore reduce the required system volume, so that sufficient hydrogen can be stored onboard all vehicle platforms to provide at least a 300-mile driving range.

Advanced hydrogen storage technologies include sub-ambient temperature compressed storage and materials-based storage. The density of hydrogen increases at reduced temperature so the use of cold (150 K to near-ambient) or cryogenic (<150 K) temperatures offers the potential to reduce overall system volume. These storage tanks require insulation to minimize heat leakage into the stored hydrogen.

Materials-based storage technologies takes advantage of the fact that significantly higher hydrogen densities at lower pressure (typically 100 bar or less) can be obtained when adsorbed on the surface of porous solids or bonded to other elements within compounds. The three primary classes of materials are hydrogen adsorbents, reversible metal hydrides, and chemical hydrogen storage materials, which are described below:

- For adsorbents, high-surface area, micro-porous materials, such as activated carbons and metal organic frameworks (MOFs), are being developed for hydrogen and natural gas storage. While many of the preferred material characteristics are similar for hydrogen and natural gas adsorption, a key difference is that the van der Waals binding strength for hydrogen is much lower, resulting in the need for cryogenic temperatures for significant adsorption. Therefore, development of materials with high micro-pore density as well as having higher hydrogen binding strengths is required.<sup>56</sup>
- Reversible metal hydride hydrogen storage is fairly mature and well-proven, as it is the basis of nickel-metal hydride (NiMH) battery technology, but the conventional intermetallic alloys used are considered too expensive and too heavy for LDV hydrogen storage applications. Therefore, development of hydrides composed primarily of lighter elements is required.<sup>57</sup>
- Chemical hydrogen storage materials are compounds with strongly bound hydrogen where the hydrogen is released through non-equilibrium processes, and thus cannot be recharged simply through application of pressurized hydrogen. While materials in this class have been developed for several niche applications, materials need to be easily filled onboard for automotive use and the spent product easily removable from the vehicle. In addition, the spent materials will need to be regenerated efficiently at low cost.<sup>58</sup>

While some promising storage materials have been identified, no single material meets all storage targets simultaneously; to address this will require R&D on advanced storage materials. To support and accelerate the advancement of hydrogen storage materials, a database to provide the research community with easy access to searchable, comprehensive, and up-to-date materials data on adsorbents, chemicals, and metal hydrides, in one

central location has been developed.<sup>59</sup> The database includes information from research pulled from a number of sources, including the historical Hydride Information Center database.<sup>60</sup>

The system engineering of all the materials-based technologies is at an early stage of development, but validated models are emerging and were used to predict the performance for the materials-based systems in Table 8.10.<sup>61</sup> These complete system models have been developed and are available as a tool online so that materials developers can project how their developed materials would perform when incorporated into a complete system for automotive application.<sup>62</sup>

**Table 8.10** Hydrogen Storage Targets for FCEVS and Projected Hydrogen Storage System Performance for Type IV Tanks and Materials-Based Systems (current technology at high volumes)<sup>55</sup>

	Gravimetric kWh/kg (kg H <sub>2</sub> /kg system)	Volumetric kWh/L (kg H <sub>2</sub> /L system)	Costs \$/kWh @500k/yr (\$/kg H <sub>2</sub> )
Storage targets			
2017	1.8 (0.055)	1.3 (0.040)	\$12 (\$400)
Ultimate	2.5 (0.075)	2.3 (0.070)	\$8 (\$266)
Projected hydrogen storage system performance			
700 bar compressed (Type IV)	1.5	0.8	17
350 bar compressed (Type IV)	1.8	0.6	13
Metal hydride (NaAlH <sub>4</sub> )	0.4	0.4	TBD
Sorbent (MOF-5, 100 bar) MATI, LN2 cooling [HexCell, flow-through cooling]	1.1 [1.2]	0.7 [0.6]	16 [13]
Chemical hydrogen storage (AB-50 wt.%)	1.7	1.3	16

For near-term compressed hydrogen storage systems, reducing system costs and packaging them for vehicles requires R&D to address the following:

- **Composites:** Low-cost, high-performance composites to lower costs while maintaining performance
- **Materials:** Alternative high-strength materials that can be used for balance-of-plant components in high-pressure hydrogen service applications
- **Conformability:** Systems capable of having non-cylindrical shapes to be packaged onboard vehicles more efficiently

For the long-term, advanced storage technologies with significantly improved energy density are important for system performance. Successful development of cold/cryogenic compressed hydrogen storage requires research, including in the following areas:

- **Composite performance:** Improved understanding of the performance of composite materials in cryogenic, high-pressure gas storage applications
- **Dormancy:** Low-cost, high-performance insulation and system designs that will minimize thermal leakage into the system, allowing for longer-term storage without venting of the stored hydrogen

Successful development of materials-based hydrogen storage technologies requires research, including in the following areas:

- **System engineering:** Improved understanding of system-level performance and modeling the translation from materials' performance to system performance
- **Hydrogen adsorbents:** High surface area materials with improved pore density to increase energy density and with higher van der Waals bonding so that significant hydrogen adsorption occurs near ambient temperatures
- **Reversible metal hydrides:** Materials with greater durability and that have higher storage capacity by mass and with fast kinetics within the operating temperature range of the fuel cell
- **Chemical hydrogen storage materials:** Materials that are liquid throughout the states of hydrogen charge/discharge and operating temperature range that can be regenerated efficiently and at low cost

### 8.5.3 Fuel Cell Vehicle Systems

A safe, cost-effective, and convenient vehicle-infrastructure interface is a key issue for the widespread deployment and consumer acceptance of FCEVs. While the hydrogen production component of infrastructure is covered in Chapter 7, the dispenser-vehicle interface—including refueling protocols to ensure a typical three to five minute fueling time—needs to be addressed. Pre-cooling is the strategy currently planned to avoid overheating of storage tanks during fast-fueling of FCEVs at high pressures, but in the long-term novel refueling strategies or lower-pressure operation would reduce cost and complexity. Additional areas requiring further work for successful development include: communication between the vehicle and the dispenser, metering to ensure accurate amounts of hydrogen dispensed, sensor technology both for hydrogen and contaminants, and the impact of fuel quality.

R&D can provide critical data required for the development of technically sound codes and standards, a prerequisite for safe deployment and large-scale commercialization. For example, an update to the hydrogen bulk storage separation distances used in key codes (e.g., National Fire Protection Association [NFPA] 52 and NFPA 2) reduced required separation distances by as much as 50%.<sup>63</sup>

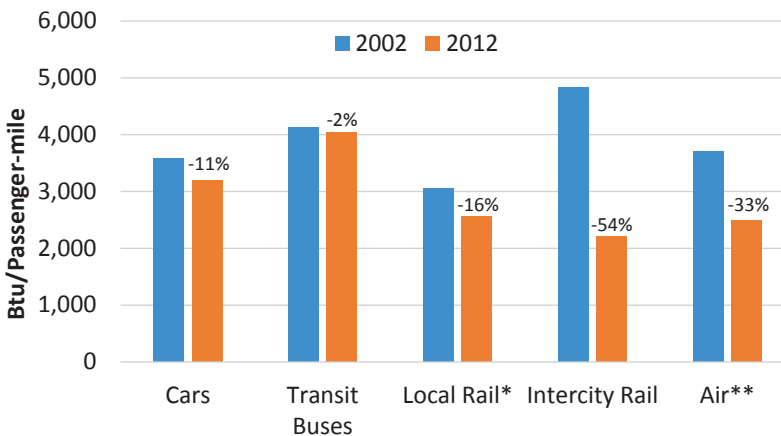
Finally, from a systems perspective, the opportunity for vehicle-to-grid (V2G) or vehicle-to-building (V2B) in the case of hydrogen FCEVs has largely been unexplored. As with PEVs, V2G and V2B systems would enable FCEVs to provide power to the electricity grid or building, respectively, when needed, such as during peak electricity load times or when backup power is needed.<sup>64</sup> The concept of a power offtake unit that allows the nominally 100 kW fuel cell in a FCEV to power a home for several days needs to be investigated to assess viability, economic value, and impact on component durability. Such approaches may improve the cost-benefit proposition for the consumer and provide options for backup or emergency power operation for a number of applications.

Ultimately, the market success of a new hydrogen or fuel cell technology may be driven by its ability to reach self-sustaining commercialization. Therefore, an important research activity is identifying niche markets for the technologies to exploit economies of scale. Research into overcoming logistical and infrastructure barriers is an important task because it resides outside the purview of most private industries, but is critical to building a large-scale hydrogen economy.

## 8.6 Other Modes

This assessment focuses on the highest energy-consuming sectors, light-duty vehicles and heavy trucks, as described in Section 8.1. However, energy consumption by other modes is increasing, and the U.S. Energy Information Administration projects that while energy consumed by all U.S. transportation will remain nearly flat from 2015 to 2040, the demand from trucks (medium and heavy duty), air, and off-highway modes will increase by 27%, 13%, and 15%, respectively.<sup>65</sup> By 2040, air, water, off-highway, and rail are projected to

**Figure 8.16** Energy per Passenger-mile by Mode in 2002 and 2012 with Percent Change from 2002 to 2012 Shown Above the 2012 Bars<sup>66</sup>



\* Passenger mile-weighted average of transit and commuter rail

\*\* Commercial (certificated route) aviation, including domestic scheduled service and one-half of international scheduled service

passenger travel and freight movement are discussed below in terms of energy intensity (EI) improvement, which comprises technology and operational efficiency improvements in aviation, marine, pipeline, rail, and off-road transportation modes. EI is the energy per unit activity, where activity metrics are defined for each mode as described in the following sections. Though these modes are relatively understudied, especially in comparison to the highway modes discussed previously in this chapter, analysis has indicated that energy intensity improvements are possible, both through direct technology improvements (either by mode-specific R&D, or by spillover benefits from R&D in light- medium-, or heavy-duty vehicle research with analogous applications in these modes) or operational optimizations. The collected estimated possible improvements are summarized in Table 8.11.

### 8.6.1 Aviation

Aviation comprises 71% domestic, 19% international, and 10% general aviation. Aviation EI is computed as energy per revenue passenger-mile. Technologies that enhance aviation EI include improved compressor operation, geared turbofan engines, open rotor and/or high bypass ratio engines, reduced weight through increased use of composite materials, longer and thinner wings with truss-braced design, blended winglets to improve lift, and riblets to reduce turbulence and drag. By 2050, these technologies are projected to reduce EI by 40%–50%. Operational improvements that reduce EI include increased load factor and controlled airport approach, takeoff, and landing procedures (better air traffic management). Other long-term improvements—not likely to be introduced before 2030—are blended wing design (moving away from tube-and-wing design), high aspect ratio wings, laminar or hybrid laminar flow wing design, and slower cruise speed at high altitude. The projected EI reduction potential is 40% by 2035 and 65% by 2050 based on review of available literature.<sup>68</sup>

Aircraft engines can use petroleum jet fuel blended with two types of biofuels: hydro processed renewable jet fuel and pyrolysis jet fuel. American Society for Testing and Materials (ASTM) International has approved up to 50% blend of biofuels with petroleum jet fuel, which would complement efficiency benefits.<sup>69</sup>

### 8.6.2 Marine

Marine energy use in the United States is 82% for freight movement and 18% for recreation. The recreation energy consumption has varied little historically, and is not expected to change dramatically. Marine EI is computed as energy per ton-mile for domestic marine and energy per billion dollars of trade for international marine.

consume the equivalent of 1.4, 0.4, 0.5, and 0.3 million barrels of oil per day, respectively. Therefore the technical potential for increasing the energy efficiency of these modes and for the use of alternative fuel in these modes is worth consideration.

The energy efficiency of passenger travel—as measured by energy per passenger-mile—by non-highway modes has increased in recent years, particularly for air and rail, as shown in Figure 8.16. Potential future improvements in energy efficiency of non-highway modes for both

**Table 8.11** Estimated Possible Energy Intensity Gains Through 2050 in Other Modes

	Aviation	Domestic marine	International marine	Pipeline	Rail	Off-road
Projected activity growth	156% <sup>§</sup>	-24% <sup>‡</sup>	484% <sup>Δ‡</sup>	40% <sup>‡</sup>	5% <sup>‡</sup>	15% <sup>¶</sup>
Business as usual energy intensity reduction	29% <sup>§</sup>	13% <sup>‡</sup>	87% <sup>‡</sup>	13% <sup>‡</sup>	22% <sup>‡</sup>	5%
Achievable energy intensity reduction	65%	20%	90%	25%	35%	15%
Net change	-10%	-39%	-42%	5%	-32%	-2%

<sup>§</sup> FAA<sup>67</sup> projections extrapolated

<sup>‡</sup> U.S. Energy Information Administration AEO 2014 projections extrapolated

<sup>Δ</sup> Growth in dollar value of trade (EIA)

<sup>¶</sup> Projected at half the population growth

Note: Net Change = (1+Activity Growth) \* (1-EI Reduction) - 1

Technologies that improve existing domestic marine vessel EI include improved hull retrofit, scalloped aft ends, and streamlined support brackets for propellers. Additional improvement can be achieved through replacing old propellers with flattened ducted propellers and replacing old engines with newer, more energy efficient engines. New vessel EI can be improved with more efficient engines, optimized hull design, air lubrication, and diesel electric propulsion. Such technologies as whale-tail propulsion (a cylindrical wheel with blades that simulate whale-tail action to propel ships) and increased use of lightweight materials may have longer payback periods. Larger capacity barges would improve EI, but may not achieve widespread acceptance due to waterway limitations. A 20% improvement in domestic marine EI is possible by 2050.<sup>70</sup> Combined, these technologies have higher EI improvement potential, but because marine vessels have forty- to fifty-year service lives, the improvement potential is lowered.

Technological and operational changes would improve international marine EI. Operational changes include reduced speed (slow steaming), route planning, use of on-shore energy sources for hotel power while at ports (cold ironing), vessel load management, traveling at steady power, optimizing propeller pitch and rudder management, and ballast management. Technological changes include optimized vessel design, use of lightweight materials, transverse thruster openings, coatings that reduce friction, bulbous bows, optimized propeller designs, efficient engines, engine waste heat recovery, and use of sails and Flettner rotors. These measures are estimated to improve international marine energy intensity by 90%.<sup>71</sup>

Marine engines can use petroleum fuels blended with such biofuels as pyrolysis and Fischer-Tropsch diesels. Marine engines can also operate on liquefied natural gas (LNG). However, the existing engines would require retrofitting to operate on LNG.

### 8.6.3 Pipeline

Natural gas pipelines use natural gas and electricity to transport natural gas, while other pipelines use electricity. Natural gas pipelines used 0.69 quads of natural gas and 0.01 quads of electricity in 2010, while other pipelines used 0.07 quads of electric energy.<sup>72</sup> Natural gas pipeline EI is computed as energy per thousand cubic feet.

Pipeline EI can be improved by replacing older less efficient natural gas internal combustion engines and compressors with new and more efficient units. Also, new pipelines would use more energy efficient engines

and compressors. The estimated EI improvement potential for pipelines is 15% by 2030 and 25% by 2050, both over the 2010 value.<sup>73</sup>

#### 8.6.4 Rail

Rail energy is used 16% by passenger and 84% by freight rail. The freight rail energy intensity is measured as energy per ton-mile. Freight rail energy intensity has been halved since 1980<sup>74</sup> through more efficient locomotives, changes in commodity mix, longer trains (more cars per train with better use of motive power), increased use of longer unit trains with higher-capacity rail cars, and improved operation. The mode is continuously improving with more locomotives equipped with alternating current (AC) motors. AC motors provide more adhesion and tractive power at low speeds, making it possible to use fewer locomotives. New locomotives also use the latest diesel engine technology, which has higher thermal efficiency. Rail lubrication and steerable (or radial) trucks (in rail, trucks are the frame that holds the wheelsets) can also reduce friction and improve energy intensity. Operation-related improvements include system wide acceptance of electronically controlled pneumatic brakes and positive train control. The rail mode has potential to achieve a 17% improvement in energy intensity by 2030 and a 35% reduction by 2050, both relative to 2010.<sup>75</sup>

At present, a majority of passenger rail energy consumption is for local travel by transit rail (51%) and commuter rail (34%). However, intercity high-speed rail has potential to divert passengers from light-duty vehicles and aviation in congested corridors. The energy intensity of high speed rail, measured as energy per passenger-mile, would depend on its load factor, so it is difficult to project high speed rail's EI advantage. However, it could be 25%–50% lower than low-occupancy light-duty vehicles and short-range air travel.<sup>76</sup>

Rail locomotives can use petroleum diesel blended with pyrolysis diesel and Fischer-Tropsch diesel. Locomotives can also operate on LNG. However, existing locomotives will require retrofitting to operate on LNG. Hybrid locomotives that store energy from braking or downhill travel for onboard use have been demonstrated but are not yet widespread.

#### 8.6.5 Off-Road

Off-road equipment comprises primarily construction and mining (37.5%), agricultural (23.4%), lawn and garden (15.3%), and industrial (14.8%) equipment, with an additional 9% accounted for by other categories. Fuel consumed is typically diesel (69%), gasoline (22%), LPG (8%), or CNG (<1%). The total energy use by off-road equipment is approximately 2.4 quads. Off-road equipment EI is computed as energy per hour of operation. Off-road petroleum is often not counted in transportation because fuel used is not subject to motor vehicle taxes, but technologically, the equipment is somewhat similar to on-road, heavy-duty transportation.

Major off-road equipment manufacturers are researching technologies that would improve energy intensity of off-road equipment. John Deere has introduced hybrid electric lawn equipment<sup>77</sup> and a front-end loader for commercial use,<sup>78</sup> while Caterpillar has introduced a hybrid electric excavator.<sup>79</sup> Vyas and colleagues<sup>80</sup> estimated that a 15% improvement in off-road energy intensity was possible by 2050, decreasing petroleum use and GHG emissions per hour of service.

As with highway vehicles, off-road equipment can use bio-based or alternative fuel diesel substitutes to complement efficiency.

### 8.7 Vehicle Automation

Vehicle automation refers to the ability of a vehicle to operate with reduced or without direct human operation. Using a combination of advanced sensors and controls, sophisticated learning algorithms, and global positioning system and mapping technologies, demonstration vehicles have been able to operate in varied environments and over long distances with a human driver present but not operating the vehicle. This



new technology has led to speculation that automation could enable dramatic changes to the transportation system, with a focus on improved safety, reduced congestion, and novel services and business models. However, automation of the transportation system may also have dramatic effects on transportation energy use. While the final effects will depend on an enormous variety of behavioral factors, system effects, and policies, early estimates point to a wide range of possible outcomes. If only the energy benefits of automation manifest, there is the potential for a dramatic improvement in vehicle petroleum use and greenhouse gas emissions, but unintended consequences could reduce or even reverse those benefits.

The U.S. Department of Transportation defines automated vehicles<sup>81</sup> as “those in which at least some aspects of a safety-critical control function (e.g., steering, throttle, or braking) occur without direct driver input.” Autonomous vehicles are the subset of automated vehicles where self-driving operation is possible. The term “Connected and Automated Vehicles” (CAV) represents a broader category of vehicles with advanced information technology functionality. Connected refers to the ability of vehicles to communicate with each other (“vehicle-to-vehicle,” or V2V), or with the physical infrastructure, (“vehicle-to-infrastructure,” or V2I).

The National Highway Traffic Safety Administration (NHTSA) has defined five levels of automated vehicles (AV) functionality, ranging from no AV features (Level 0) to full automation without the need for a human driver (Level 4). Levels 1 and 2 are defined as more limited AV capability, including lane assist, adaptive cruise control, and collision avoidance technology, either operating independently (Level 1) or in unison (Level 2). Level 3 refers to limited automation, enabling “the driver to cede full control of all safety-critical functions under certain traffic or environmental conditions,” but expecting the driver “to be available for occasional control” with adequate warning. The Society of Automotive Engineers<sup>82</sup> has expanded these definitions to include Level 5 (full automation without driver controls).

Automation requires a confluence of sensors, automotive technologies (such as drive-by-wire), and information technology such as machine learning and processing of large datasets. Although work on automation has been conducted in academic labs since at least the 1980s, the modern fully-automated vehicle has roots in a series of Defense Advanced Research Projects Agency “grand challenges” from 2004 to 2013 that required teams to build vehicles that could navigate a desert or urban course with no human intervention based on a suite of novel technologies:

- **Cameras**, which are mounted on various locations to identify and monitor terrain, traffic signals, road markings, identify pedestrians, cyclists, other vehicles, and inanimate obstacles.
- **Radar**, which is often mounted on the front and rear bumpers for detection and range finding of faraway objects.
- **LIDAR**, a portmanteau of light and RADAR, which uses spinning lasers in a radar-like application. It is mounted on the roof of the car and scans a wide radius to precisely measure the distance to nearby objects and map physical terrain.
- **GPS units**, which use data from satellites to determine vehicle location that are then compared to detailed maps of physical features, known hazards, and lane and traffic structures.

Most major manufacturers that have announced CAVs have deployed some automation technology for safety, and are adding technologies to more models by 2017. Some Level 3 systems are expected between 2017 and 2020. Google has announced plans to release a NHTSA-Level 4 (full AV) system by 2017,<sup>83</sup> and Tesla has announced its intention to do so by 2020.<sup>84</sup> Even with these announcements, researchers disagree by decades on if and when highly automated CAVs will become generally available, and how widespread they will become.

The most commonly cited potential benefits of CAVs are improved safety, reduced or more manageable traffic congestion, higher service quality, and availability of affordable transportation to those who are currently underserved. But automation is a key factor for the future of transportation energy as well. Researchers<sup>85</sup> have

noted that there are a wide variety of possible effects of a highly automated transportation system, some of which are likely to be beneficial for energy, while others could increase energy demand.

Estimates of these effects and their possible interactions vary widely. Use intensity may increase (i.e., more travel, new passengers) or decrease (i.e., high-occupancy vehicles, less hunting for parking); energy intensity may increase (faster travel) or decrease (vehicle redesign, efficient driving and routing, and platooning); and fuel intensity may significantly decrease due to symbiosis with advanced alternative fuel technologies, such as PEVs or FCEVs. Early summary analysis implies that the energy implications of CAVs may be large, with cases ranging from more than a 90% savings in petroleum use and emissions if only benefits occur, to more than a 250% increase if only the fuel-increasing effects are manifested. Improvements to traffic systems and infrastructure management can reduce losses from congestion, but could also induce additional travel.

Freight technology can also benefit from automation. Platooning has been demonstrated to improve fuel economy 5%–10% in test hauls,<sup>86</sup> and routing and logistics can potentially be improved. However, automation by ground-based or air-based drones could enable cheap and rapid at-home delivery twenty-four hours a day, potentially increasing overall goods movement and energy use.

The future policy landscape for CAVs is highly uncertain at the federal and state level. Legal allowance of automated function, licensing for vehicles, and fault and insurance issues will all need to be worked out over time for long-term policy success. Technology will be a key part of these discussions, as the performance of the vehicles and their rate of safe operation is at the heart of each of these policy issues.

The energy implications of CAVs may also be shaped by current and future policies. Current fuel economy standards do not take the operation of the vehicle into account, so the rating of a vehicle would not be affected by either an efficient or inefficient driving algorithm.

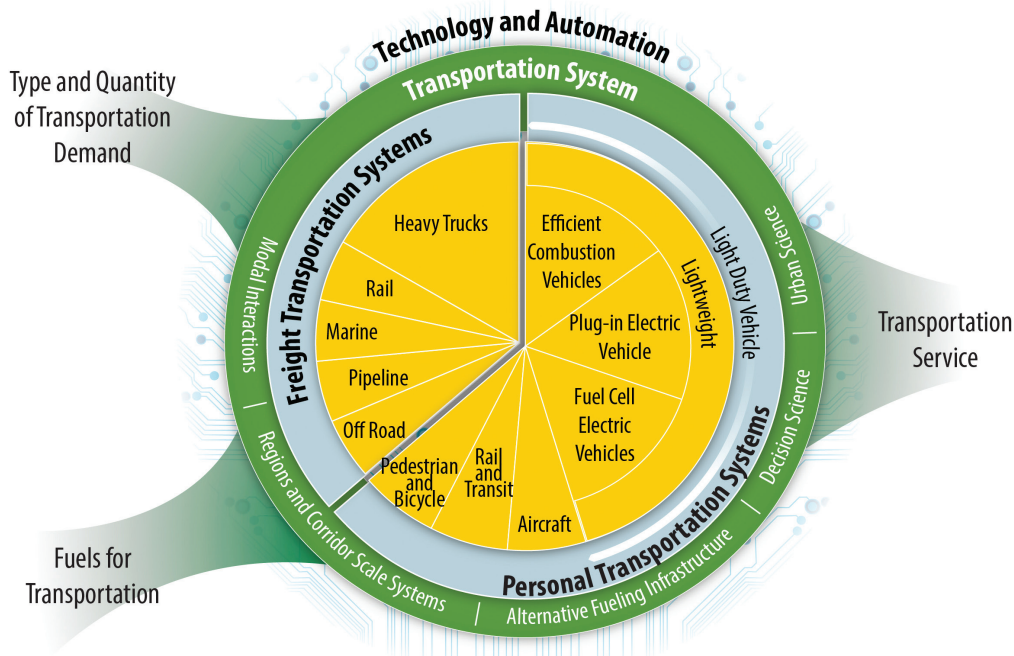
## 8.8 Transportation as a System

Transportation technology priorities should be considered in the context of the entire transportation system of the United States and with links to other energy systems. Effects of improvements to one technology or mode depend upon a complex web of interactions and interdependencies that can moderate or magnify effects estimated in isolation. Particularly when significant changes are targeted, such as deep reductions in greenhouse gas emissions and petroleum use, effects of technological change must be measured across the whole system. This systems approach considers the interactions and interdependencies, describing the boundaries, external influences, and internal characteristics. With an evolving social and urban landscape and dramatic new technology changes, the transportation system of the future may be significantly improved from today in ways that are challenging to forecast and will affect R&D priorities. Research in multi-scale modeling can allow linking of insights at the technology subsystem level, through technology systems, and all the way up to macro-scale issues and interactions. Additionally, the transportation system is within the mission space of a variety of federal, state, and local organizations, so strong collaboration around R&D topics can improve future outcomes.

Technological change can also provide new alternatives to meet service needs, for example, through information technology that substitutes for physical movement. Similarly, while current business models and technologies have developed together, technological changes could give rise to new opportunities, such as greater sharing of personal vehicles or increased flexibility in freight logistics. Historically, most transportation involved people or goods traveling from point A to point B in a single vehicle acting independently. Soon, nearly all vehicles, both personal and freight, will be able to receive and transmit massive amounts of data.

Because of the system's complexity, there are many ways to categorize and describe systems opportunities. This chapter addresses six system-related opportunities in detail which interact with progress in individual vehicle technologies (Figure 8.17): decision science, urban sciences, alternative fuels infrastructure, corridor or regional scale systems, and modal interactions, in addition to connected and automated vehicles (discussed in Section 8.7).

**Figure 8.17** Transportation as a System of Systems. This schematic shows that the transportation system is a complex, nested system of systems that interacts with many other aspects of the economy. Its needs are defined by demand for services. Its inputs are fuels of various characteristics (discussed in detail in Chapter 7). And its output is the transportation service that moves the rest of the economy. The transportation system itself includes many modes and technologies with diverse characteristics for personal and freight movement, and is influenced by information technology and other overarching trends and factors.



Each of these areas can be addressed through tool development, visualization, analysis, system integration, and potentially technology R&D and enabling policies. They will also be enabled by investment in basic science and advanced modeling capabilities, which can support research across the transportation portfolio. The specific areas addressed here are given as key examples and a strong ongoing systems analysis will allow better identification of future needs to capture energy system improvements.

### Decision Science

On the demand side, non-technology human factors, including consumer (vehicle purchase) and driver (vehicle use) behavioral considerations play important roles in determining real-world effectiveness of vehicle technologies. One of the biggest uncertainties in the development of a future transportation system is how behavior will change in reaction to the new technologies and new system paradigms. For example, to what extent will reduced marginal costs of travel result in increased travel (the rebound effect)? It will be critical to understand how to make transportation systems effective, especially since cost competitiveness of clean transportation technologies alone is insufficient for widespread adoption; consumer behavior is a key barrier.<sup>87</sup>

Specific considerations about consumer and driver preferences and behavior could benefit significantly from recent and near-term advances in information technology and resulting data from vehicles. As transportation systems are increasingly connected, they can generate vast amount of data in real time. When combined with other equally vast data sets from other sources, such as intelligent infrastructure, and processed quickly enough to provide information back to vehicles and travelers this enables real-time decision making to maximize vehicle and route efficiency.

Additionally, information technology may have a significant role to play in facilitating travel behavior and demand reduction, enabling a variety of substitutes for transportation, creating feasible mechanisms to address certain transportation market failures, and increasing time and energy efficiency. A wide range of activities previously requiring travel can now be accomplished via the Internet, ranging from telecommuting/teleworking to Internet-based public services and Internet commerce, though these may induce other travel, such as commercial delivery, or other energy use. Information technology could serve a role in allowing better management of externalities, such as the opportunity for improved pricing of transportation resources, especially the roadway network. Significant changes in per-capita personal vehicle travel could occur, either the logical result of an improved set of alternatives based on information technology, decision tools, alternative modes, and changes in urban form, or the unexpected result of changing demographics. Scenarios for a 25% reduction in per-capita vehicle miles of travel by 2050 have been explored in the context of deep GHG emissions reductions.<sup>88</sup>

### Urban Sciences

The world, including the United States, is becoming more urban as part of a long trend toward city living. This may influence areas of focus within the R&D portfolio and is in itself a topic for research as it has significant energy implications. Cities with smart infrastructure and thoughtful design appear to require less energy use for transportation. On longer time scales, new transportation systems will also affect the choices of where to live and work, which, in turn, will drive the evolution of future cities.

Research could enable advancements in the following areas:

- **Integrated and optimized design, planning, and operation:** Tools to optimize zoning, building design, transportation design, and operation with water and energy delivery and city operations
- **Models and analytics:** New city-scale computational models calibrated and validated by sensor and operational data and frameworks and analytical tools for composite models of urban components
- **Sensors, measurements, real-time data:** To enable real-time optimization of traffic and individual vehicles, building energy use and delivery based on conditions

### Alternative Fueling Infrastructure

Many advanced vehicles require different fueling infrastructure than conventional vehicles, such as charging for PEVs and hydrogen supply for FCEVs. A lack of or sub-optimal distribution of that infrastructure is likely to be a barrier to alternative fuel vehicle adoption. A smart fueling infrastructure that can best allow use of low-carbon energy sources when they are available can also decrease the emissions of the transportation fleet. Information technology and a smart infrastructure can also enable users to find and easily interact with fueling systems; for example, by locating and finding the status of stations. Additionally, different vehicles and infrastructures may be best suited for deployment in different geographic regions, so linking to corridor and local planning (see below) can support deployment. More discussion of fuel supply can be found in Chapter 7.

### Corridor and Regional Scale Systems

In transportation, most infrastructure is planned, funded, and maintained locally or at the regional level. More municipalities are working together to systematically plan transportation investments using more sophisticated tools. There may be significant opportunity to improve the energy and emissions performance of the transportation system if better tools can be developed and used to include these factors. Because of the geographic, economic, and cultural diversity of the United States, different strategies are likely to be more successful in different regions. R&D can provide tools to improve planning of infrastructure for successful expansions of new technologies, thereby reducing investment risk and increasing energy and environmental benefits.

## Modal Interactions

For passenger and freight transportation, different modes have very different energy intensity and service characteristics (see Section 8.6). Choice of mode depends on a wide variety of technological, system, and social factors. Examples of influencing factors for mode choice include legislative and regulatory constraints, policy and incentives, trip time, cost (variable and capital), capacity (occupants and cargo, as well as system), reliability, availability, environmental considerations, convenience, and personal space. With so many interacting factors, to facilitate better understanding of mode choice and the energy implications requires research.

Understanding of the modal interactions can also support R&D portfolio planning. For example, technologies developed for one application (such as advanced diesel engines for heavy trucks) can in many cases also benefit other applications (such as off-road equipment). Information technology presents opportunities for logistical advances that can change time and energy performance through improved integration of personal transportation modes with mass transportation, improved freight logistics, and information technology-enabled vehicle sharing or novel business models for providing transportation services.

## Interactions with Other Systems

The transportation system features extensive interdependencies with many other sectors of the economy, including transportation demand-inducing activities of individuals and businesses, economic effects on the type and quantity of transportation supply, and various energy systems. Individuals influence the quantity of personal transportation needed through their decisions about where to live and work, where to pursue educational and leisure activities, and where and how to purchase household goods. Businesses influence commercial transportation demand through their locations, manufacturing supply chains, shipping of finished goods, and delivery of goods and services to customers. Other economic sectors influence the type and quantity of transportation supplied; for example, through the costs of the raw materials used for fuel, vehicles, and infrastructure. Transportation interacts dynamically with energy systems for electricity, energy storage, and heating. Interactions between the transportation system and other systems are discussed in Chapter 2. The fuel system, discussed in detail in Chapter 7, links the transportation system to other economic sectors, and includes extraction, processing, distribution, and use of fuels for transportation. While primarily based on petroleum today, technological changes are improving other options that include biofuels and the energy carriers electricity and hydrogen.

## 8.9 Conclusion

Transportation provides essential services to individuals and to the economy but is the primary user of petroleum in the United States and a major emitter of air pollution and greenhouse gases. There are numerous technology RDD&D options to address these challenges spanning the transportation system. These include light-duty vehicles, trucks, rail, marine, aircraft, pipelines, and transportation system considerations. This assessment focuses on the light-duty vehicle and heavy-duty truck modes as top priorities as these modes currently account for approximately three quarters of transportation energy use and emissions. However, other modes and crosscutting system effects are also addressed because their importance is likely to grow as progress reduces the impacts of now-dominant modes. Additionally, a systems perspective is increasingly important in research portfolio planning and the Quadrennial Technology Review (QTR) addresses opportunities to leverage greater improvements through systems considerations.

To address energy security and economic challenges, pathways to reduce oil imports and oil use are needed across the transportation sector to increase viable substitutes and expand consumer options, which can provide a hedge against price volatility. To dramatically reduce GHG emissions, a larger share of vehicles must efficiently

use fuels or power with no on-board carbon-based fuel (or produced from bioenergy) as it is not possible to capture and store onboard carbon dioxide emissions from small, mobile sources. The QTR presents a set of complementary technology opportunities that together inform a possible integrated R&D strategy for GHG emissions reduction involving efficiency improvement, electric drivetrains, renewable fuels, and transportation system efficiencies. Dramatic improvements throughout the system will be necessary to achieve national goals for petroleum use and greenhouse gas reductions. This urgency implies that a coordinated, sustained, and continually improving transportation R&D portfolio is a vital component of the national energy agenda.

## Chapter 8: Advancing Clean Transportation and Vehicle Systems and Technologies

# Technology Assessments

- 8A** Connected and Automated Vehicles
- 8B** Fuel Cell Electric Vehicles
- 8C** Internal Combustion Engines
- 8D** Lightweight Automotive Materials
- 8E** Plug-in Electric Vehicles

[See online version.]

### Endnotes

- <sup>1</sup> Congressional Budget Office. “Public Spending on Transportation and Water Infrastructure.” Accessed June 18, 2015: <http://www.cbo.gov/publication/21902>.
- <sup>2</sup> U.S. Energy Information Administration. “Petroleum and Other Liquids.” Accessed June 18, 2015: <http://www.eia.gov/petroleum/>.
- <sup>3</sup> U.S. Energy Information Administration. “Monthly Energy Review.” Available at: <http://www.eia.gov/totalenergy/data/monthly/>, Tables 2.5, 3.5, 3.7c. “Annual Energy Outlook 2014.” Available at: <http://www.eia.gov/forecasts/archive/aeo14/>, Tables 7, 45, 46.
- <sup>4</sup> U.S. Environmental Protection Agency. “Sources of Greenhouse Gas Emissions.” Accessed June 18, 2015: <http://www.epa.gov/climatechange/ghgemissions/sources/transportation.html>.
- <sup>5</sup> White House Fact Sheet. “U.S.-China Joint Announcement on Climate Change and Clean Energy Cooperation.” Accessed April 1, 2015: <https://www.whitehouse.gov/the-press-office/2014/11/11/fact-sheet-us-china-joint-announcement-climate-change-and-clean-energy-c>.
- <sup>6</sup> Oak Ridge National Laboratory. “Transportation Energy Data Book 2014.” Table 12.1. Available at: <http://cta.ornl.gov/data/chapter12.shtml>.
- <sup>7</sup> Oak Ridge National Laboratory. “Transportation Energy Data Book 2014.” Edition 33, Tables 1.15, 1.16, and 11.6. Available at: <http://cta.ornl.gov/data/chapter1.shtml>.
- <sup>8</sup> The National Petroleum Council is a federal advisory committee to the Secretary of Energy, providing advice primarily on issues related to oil and natural gas but also conducting detailed studies on alternative fuels, including the 2012 “NPC Future Transportation Fuels Study: Advancing Technology for America’s Transportation Future.” Available at: <http://www.npc.org/FTF-80112.html>.
- <sup>9</sup> The Secretary of Energy Advisory Board is a federal advisory committee to the Secretary of Energy, providing advice on issues related to all types of energy.
- <sup>10</sup> The National Academy of Sciences (NAS) and National Academy of Engineering (NAE) are nongovernmental, nonprofit societies of distinguished scholars. Established by an Act of Congress, signed by President Abraham Lincoln in 1863, the NAS (and now, also NAE) are charged with providing independent, objective advice to the nation on matters related to science and technology.
- <sup>11</sup> U.S. Department of Energy. “Well-to-Wheels Greenhouse Gas Emissions and Petroleum Use for Mid-Size Light Duty Vehicles.” Program Record #13005 (revision #1), 2013. Available at: [http://www.hydrogen.energy.gov/pdfs/13005\\_well\\_to\\_wheels\\_ghg\\_oil\\_ldvs.pdf](http://www.hydrogen.energy.gov/pdfs/13005_well_to_wheels_ghg_oil_ldvs.pdf).

- <sup>12</sup> National Academy of Sciences. “Transitions to Alternative Vehicles and Fuels.” 2013. Available at: <http://www.nap.edu/catalog/18264/transitions-to-alternative-vehicles-and-fuels>.
- <sup>13</sup> U.S. Department of Energy. “Transportation Energy Futures Study.” Accessed June 18, 2015: <http://www1.eere.energy.gov/analysis/transportationenergyfutures/>.
- <sup>14</sup> Based on the IWG report outlining CO<sub>2</sub> prices to use in policy making.
- <sup>15</sup> U.S. Department of Energy. “Vehicle Technologies Program Government Performance and Results Act (GPRA).” Report for Fiscal Year 2015, ANL/ESD-14/3. Available at: <http://www.transportation.anl.gov/pdfs/G/955.PDF>.
- <sup>16</sup> CAFE standards currently require 54.5 MPG by 2025; however, owing to credits for various non-drive-cycle improvements and a gap between rated and real-world fuel economy, real world fleet performance is expected to be lower under current requirements. U.S. Environmental Protection Agency, Regulations and Standards, accessed June 18, 2015: <http://www.epa.gov/otaq/climate/regulations.htm>.
- <sup>17</sup> U.S. Environmental Protection Agency. “Tier 3 Vehicle Emission and Fuel Standards Program.” Accessed June 18, 2015: <http://www.epa.gov/oms/tier3.htm>.
- <sup>18</sup> California Air Resources Board. “Amendments to the Low-Emission Vehicle Program—LEV III. Accessed June 18, 2015: <http://www.arb.ca.gov/msprog/levprog/leviii/leviii.htm>.
- <sup>19</sup> “A Workshop to Identify Research Needs and Impacts in Predictive Simulation for Internal Combustion Engines (PreSICE).” March 3, 2011. Available at: [http://www1.eere.energy.gov/vehiclesandfuels/pdfs/presice\\_rpt.pdf](http://www1.eere.energy.gov/vehiclesandfuels/pdfs/presice_rpt.pdf).
- <sup>20</sup> U.S. Department of Energy. “Vehicle Technologies Program Multi-Year Program Plan, 2011–2015.” Available at: [http://www1.eere.energy.gov/vehiclesandfuels/pdfs/program/vt\\_mypp\\_2011-2015.pdf](http://www1.eere.energy.gov/vehiclesandfuels/pdfs/program/vt_mypp_2011-2015.pdf).
- <sup>21</sup> U.S. DRIVE, “Advanced Combustion and Emission Control Tech Team Roadmap.” June 2013.
- <sup>22</sup> Muntean, G. “CLEERS: Aftertreatment Modeling and Analysis.” FY 2014 DOE Vehicle Technologies Program Annual Merit Review, June 16–20, 2014, Washington, DC; 30 pp. Accessed March 16, 2015: [http://www.energy.gov/sites/prod/files/2014/07/f17/ace023\\_muntean\\_2014\\_o.pdf](http://www.energy.gov/sites/prod/files/2014/07/f17/ace023_muntean_2014_o.pdf).
- <sup>23</sup> “A Workshop to Identify Research Needs and Impacts in Predictive Simulation for Internal Combustion Engines (PreSICE).” March 3, 2011. Available at: [http://www1.eere.energy.gov/vehiclesandfuels/pdfs/presice\\_rpt.pdf](http://www1.eere.energy.gov/vehiclesandfuels/pdfs/presice_rpt.pdf).
- <sup>24</sup> “Report on the Transportation Combustion Engine Efficiency Colloquium Held at USCAR, March 3–4, 2010.” ORNL, October 2010. ORNL/TM-2010/265.
- <sup>25</sup> Ibid.
- <sup>26</sup> Gonder, J.; Earlywine, M.; Sparks, W. “Analyzing Vehicle Fuel Saving Opportunities Through Intelligent Driver Feedback.” 2012. Available at: <http://www.nrel.gov/docs/fy12osti/53864.pdf>.
- <sup>27</sup> “Transportation Energy Data Book 2014.” Accessed June 19, 2015: <http://cta.ornl.gov/data/index.shtml>.
- <sup>28</sup> Rotz, D. “Super Truck Program: Vehicle Project Review, Recovery Act—Class 8 Truck Freight Efficiency Improvement Project.” Accessed June 19, 2015: [http://energy.gov/sites/prod/files/2014/07/f17/arravt080\\_vss\\_rotz\\_2014\\_o.pdf](http://energy.gov/sites/prod/files/2014/07/f17/arravt080_vss_rotz_2014_o.pdf).
- <sup>29</sup> Yoon, S.; et al. “Criteria Pollutant and Greenhouse Gas Emissions from CNG Transit Buses Equipped with Three-way Catalysts Compared to Lean-burn Engines and Oxidation Catalyst Technologies.” *J. Air & Waste Management Association* 63(8), 2013.
- <sup>30</sup> Joost, W. “Reducing Vehicle Weight and Improving U.S. Energy Efficiency Using Integrated Computational Materials Engineering.” *JOM* (64), 2012; pp. 1032-1038.
- Cheah, L. *Cars on a Diet: The Material and Energy Impacts of Passenger Vehicle Weight Reduction in the U.S.* Ph.D. Thesis. Massachusetts Institute of Technology. 2010.
  - Lutsey, N. “Review of Technical Literature and Trends Related to Automobile Mass-reduction Technology.” Davis, CA: University of California, Davis, 2010. Available at: [http://pubs.its.ucdavis.edu/publication\\_detail.php?id=1390](http://pubs.its.ucdavis.edu/publication_detail.php?id=1390).
  - Casadei, A.; Broda, R. “Impact of Vehicle Weight Reduction on Fuel Economy for Various Vehicle Architectures.” Arlington, VA: The Aluminum Association, Inc., 2007. Available at: [http://www.autoaluminum.org/downloads/AluminumNow/Ricardo%20Study\\_with%20cover.pdf](http://www.autoaluminum.org/downloads/AluminumNow/Ricardo%20Study_with%20cover.pdf).
  - Bandivadekar, A.; et al. “On the Road in 2035: Reducing Transportation’s Petroleum Consumption and GHG Emissions.” MIT Laboratory for Energy and the Environment, 2008.
- <sup>31</sup> Ward’s Communications. “Ward’s Motor Vehicle Facts and Figures.” Detroit, MI, 2013; p. 52 (via “Transportation Energy Data Book”).
- <sup>32</sup> William F. Powers, “Advanced Materials Process.” 157, 2000; pp. 38-44.
- <sup>33</sup> U.S. Department of Energy. “EV Everywhere Grand Challenge Blueprint. 2013. Available at: [http://energy.gov/sites/prod/files/2014/02/f8/everywhere\\_blueprint.pdf](http://energy.gov/sites/prod/files/2014/02/f8/everywhere_blueprint.pdf).
- <sup>34</sup> Nykvist, B.; Nilsson, M. “Rapidly Falling Costs of Battery Packs for Electric Vehicles.” *Nature Climate Change* (5), 2015; pp. 329-332. doi:10.1038/nclimate2564. Available at: <http://www.nature.com/nclimate/journal/v5/n4/full/nclimate2564.html>.
- <sup>35</sup> U.S. Department of Energy. “EV Everywhere Grand Challenge: Road to Success.” 2014. Available at: [http://energy.gov/sites/prod/files/2014/02/f8/everywhere\\_road\\_to\\_success.pdf](http://energy.gov/sites/prod/files/2014/02/f8/everywhere_road_to_success.pdf).

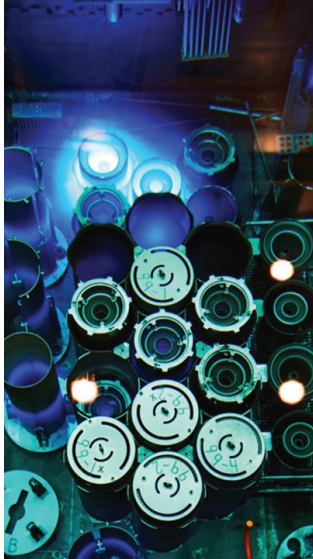
- <sup>36</sup> U.S. Department of Energy Vehicle Technologies Office. “FY 2014 Annual Progress Report—Energy Storage R&D.” Available at: [http://energy.gov/sites/prod/files/2015/04/f21/FY2014\\_APR\\_Energy\\_Storage\\_R%26D\\_FINAL\\_Part1\\_of\\_3.pdf](http://energy.gov/sites/prod/files/2015/04/f21/FY2014_APR_Energy_Storage_R%26D_FINAL_Part1_of_3.pdf).
- <sup>37</sup> U.S. Department of Energy. “Basic Research Needs for Electrical Energy Storage.” Report of the Basic Energy Sciences Workshop on Electrical Energy Storage, April 2–4, 2007. Available at: [http://science.energy.gov/~media/bes/pdf/reports/files/ees\\_rpt\\_print.pdf](http://science.energy.gov/~media/bes/pdf/reports/files/ees_rpt_print.pdf).
- <sup>38</sup> Nelson, P.; Gallagher, K.; Bloom, I.; Dees, D. “Modeling the Performance and Cost of Lithium-Ion Batteries for Electric Vehicles.” Chemical Sciences and Engineering Division, Argonne National Laboratory, ANL-11/32, Argonne, IL, USA, 2011. The model is available for download at: <http://www.cse.anl.gov/BatPaC/>.
- <sup>39</sup> U.S. Department of Energy. “EV Everywhere Grand Challenge: Road to Success.” 2014. [http://energy.gov/sites/prod/files/2014/02/f8/everywhere\\_road\\_to\\_success.pdf](http://energy.gov/sites/prod/files/2014/02/f8/everywhere_road_to_success.pdf).
- <sup>40</sup> U.S. Department of Energy, Office of Energy Efficiency & Renewable Energy. “Power America.” Available at: <http://energy.gov/eere/amo/power-america>.
- <sup>41</sup> <http://energy.gov/epsa/initiatives/department-energy-s-critical-materials-strategy>.
- <sup>42</sup> Smart, J. “Workplace Lessons Learned Through the Nation’s Largest PEV Charging Projects.” DOE Workplace Charging Challenge Summit, Alexandria, VA, November 18, 2014. Available at: <http://avt.inel.gov/pdf/EVProj/WorkplaceChargingDataInsights.pdf>.
- <sup>43</sup> “The EV Project, Q3 2012 Report.” Available at: <http://www.theevproject.com/downloads/documents/Q3%202012%20EVP%20Report.pdf>.
- <sup>44</sup> SAE International. “Utility Factor Definitions for Plug-In Hybrid Electric Vehicles Using Travel Survey Data.” Standard J2841, 2010.  
SAE International. “Recommended Practice for Measuring the Exhaust Emissions and Fuel Economy of Hybrid-Electric Vehicles, Including Plug-in Hybrid Vehicles.” Standard J1711, 2010.
- <sup>45</sup> U.S. Department of Energy. “Well-to-Wheels Greenhouse Gas Emissions and Petroleum Use for Mid-Size Light Duty Vehicles.” Program Record #13005 (revision #1), 2013. Available at: [http://www.hydrogen.energy.gov/pdfs/13005\\_well\\_to\\_wheels\\_ghg\\_oil\\_ldvs.pdf](http://www.hydrogen.energy.gov/pdfs/13005_well_to_wheels_ghg_oil_ldvs.pdf), which shows that in the early to mid 2030s, FCEVs using natural-gas-derived hydrogen would reduce GHG emissions by about 50% compared to today’s gasoline cars. Today’s FCEVs reduce GHG emissions by about 20% relative to today’s gasoline vehicles.
- <sup>46</sup> U.S. Department of Energy. “Hydrogen and Fuel Cells Program, 2013 Annual Report.” Available at: [http://www.hydrogen.energy.gov/annual\\_progress13.html](http://www.hydrogen.energy.gov/annual_progress13.html). Note: Low volume costs are much higher at roughly \$280/kW.
- <sup>47</sup> Efficiencies calculated on a lower heating value (LHV) basis
- <sup>48</sup> The most widely used fuel cell for automotive applications is the PEM fuel cell (PEMFC).
- <sup>49</sup> Industry is doing some R&D in these areas. However, public co-funding of more fundamental research at universities and national laboratories is needed in view of the challenges and the fact that DOE-EERE can leverage other federal funding (e.g., the National Science Foundation, National Institute of Standards and Technology, DOE Office of Science).
- <sup>50</sup> U.S. Department of Energy Hydrogen and Fuel Cells Program. “Record 14014: Fuel Cell System Cost—2014.” Available at: [http://www.hydrogen.energy.gov/program\\_records.html](http://www.hydrogen.energy.gov/program_records.html).
- <sup>51</sup> U.S. DRIVE. “Fuel Cell Technical Team Roadmap.” 2013. Available at: [http://energy.gov/sites/prod/files/2014/02/f8/fctt\\_roadmap\\_june2013.pdf](http://energy.gov/sites/prod/files/2014/02/f8/fctt_roadmap_june2013.pdf).
- <sup>52</sup> U.S. Department of Energy, Fuel Cell Technology Office. “Multi-Year Research, Development and Demonstration Plan.” Section 3.4: “Fuel Cells.” Accessed June 19, 2015: [http://energy.gov/sites/prod/files/2014/12/f19/fcto\\_myRDD\\_fuel\\_cells.pdf](http://energy.gov/sites/prod/files/2014/12/f19/fcto_myRDD_fuel_cells.pdf).
- <sup>53</sup> Steinbach, A.; et al. “High Performance, Durable, Low Cost Membrane Electrode Assemblies for Transportation Applications.” 2013 Annual Progress Report. Available at: [http://www.hydrogen.energy.gov/pdfs/progress13/v\\_c\\_1\\_steinbach\\_2013.pdf](http://www.hydrogen.energy.gov/pdfs/progress13/v_c_1_steinbach_2013.pdf).
- <sup>54</sup> U.S. Department of Energy, Fuel Cell Technology Office. “On-board Type IV Compressed Hydrogen System Systems—Current Performance and Cost.” Available at: [http://hydrogen.energy.gov/pdfs/13010\\_onboard\\_storage\\_performance\\_cost.pdf](http://hydrogen.energy.gov/pdfs/13010_onboard_storage_performance_cost.pdf).
- <sup>55</sup> U.S. Department of Energy, Fuel Cell Technology Office. “Onboard Type IV Compressed Hydrogen Storage Systems—Current Performance and Cost.” Available at: [http://hydrogen.energy.gov/pdfs/13010\\_onboard\\_storage\\_performance\\_cost.pdf](http://hydrogen.energy.gov/pdfs/13010_onboard_storage_performance_cost.pdf).
- For metal hydride performance see Table 1 of the “2012 Annual Progress Report of the Hydrogen Storage Engineering Center of Excellence.” IV.D.1. Hydrogen Storage Engineering Center of Excellence (HSECoE). Available at: [http://hydrogen.energy.gov/pdfs/progress12/iv\\_d\\_1\\_anton\\_2012.pdf](http://hydrogen.energy.gov/pdfs/progress12/iv_d_1_anton_2012.pdf).
  - For sorbent performance see Table 1 of Veenstra, M. “2014 Annual Progress Report.” IV.B.7. “Ford/BASF SE/UM Activities in Support of the Hydrogen Storage Engineering Center of Excellence.” Available at: [http://hydrogen.energy.gov/pdfs/progress14/iv\\_b\\_7\\_veenstra\\_2014.pdf](http://hydrogen.energy.gov/pdfs/progress14/iv_b_7_veenstra_2014.pdf).
  - For chemical hydrogen storage performance, see spider charts in Figure 1 of Semelsberger, T. “2014 Annual Progress Report.” IV.B.4. “Chemical Hydride Rate Modeling, Validation, and Storage Demonstration.” Los Alamos National Laboratory’s effort within the Hydrogen Storage Engineering Center of Excellence. Available at: [http://www.hydrogen.energy.gov/pdfs/progress14/iv\\_b\\_4\\_semelsberger\\_2014.pdf](http://www.hydrogen.energy.gov/pdfs/progress14/iv_b_4_semelsberger_2014.pdf).
- <sup>56</sup> Stadie, N. P. *Synthesis and Thermodynamic Studies of Physisorptive Energy Storage Materials*. Ph.D. dissertation. California Institute of Technology, 2013.
- <sup>57</sup> Klebanoff, L., ed. *Hydrogen Storage Technology: Materials and Applications*. Boca Raton, FL: CRC Press, 2012.
- <sup>58</sup> Brooks, K. P.; Semelsberger, T. A.; Simmons, K. L.; van Hassel, B. (2014) “Slurry-based Chemical Hydrogen Storage Systems for Automotive Fuel Cell Applications.” *J. Power Sources* (268), 2014; pp. 950-959. DOI: 10.1016/j.jpowsour.2014.05.145.



- <sup>59</sup> U.S. Department of Energy, Fuel Cell Technologies Office. “Hydrogen Storage Materials Database.” Accessed June 19, 2015: <http://hydrogenmaterialssearch.govtools.us/>.
- <sup>60</sup> Ibid.
- <sup>61</sup> U.S. Department of Energy. “Hydrogen and Fuel Cells Program FY14 Annual Progress Report.” IV.D.B. “System Design, Analysis, Modeling, and Media Engineering Properties for Hydrogen Energy Storage. Available at: [http://www.hydrogen.energy.gov/pdfs/progress14/iv\\_b\\_5\\_thornton\\_2014.pdf](http://www.hydrogen.energy.gov/pdfs/progress14/iv_b_5_thornton_2014.pdf).
- <sup>62</sup> U.S. Department of Energy, Fuel Cell Technologies Office. “Hydrogen Storage Engineering Center of Excellence.” Accessed August 10, 2015: <http://www.hsecoe.org/models.php/>.
- <sup>63</sup> U.S. Department of Energy. “Separation Distance Reduction Based on Risk-Informed Analysis.” Hydrogen and Fuel Cells Program Record # 15006, 2015. Available at: [http://hydrogen.energy.gov/pdfs/15006\\_separation\\_distance\\_reduction.pdf](http://hydrogen.energy.gov/pdfs/15006_separation_distance_reduction.pdf).
- <sup>64</sup> National Renewable Energy Laboratory. “Electric Vehicle Grid Integration.” Accessed June 18, 2015: [http://www.nrel.gov/transportation/project\\_ev\\_grid\\_integration.html](http://www.nrel.gov/transportation/project_ev_grid_integration.html).
- <sup>65</sup> U.S. Energy Information Administration. “Annual Energy Outlook 2014, Detailed Reference Case Tables.” Accessed July 2014: <http://www.eia.gov/forecasts/aeo/data.cfm>.
- <sup>66</sup> Davis, S. C.; Diegel, S. W. *Transportation Energy Data Book*. Edition 24, ORNL-6973, 2004.  
Davis, S. C.; Diegel, S. W.; Boundy, R. G. *Transportation Energy Data Book*. Edition 33, ORNL-6990, 2014. Accessed March 7, 2014: <http://cta.ornl.gov/data/index.shtml>.
- <sup>67</sup> Federal Aviation Administration. “FAA Airspace Forecast: Fiscal Years 2014–2034.” 2014.
- <sup>68</sup> Advisory Council for Aviation Research and Innovation in Europe. “Aeronautics and Air Transport: Beyond Vision 2020 (Towards 2050).” 2010.
- Åkerman, J. “Sustainable Air Transport—on Track in 2050.” *Transportation Research Part D: Transport and Environment* 10 (2), 2005; pp. 111-126.
  - Andersen, S.; Zaelke, D. *Industry Genius: Innovations and People Protecting the Climate and Fragile Ozone Layer*. Sheffield UK: Greenleaf Publishing, 2003.
  - Dryer, J. “ARMD Fundamental Aeronautics Program.” In *NASA Green Aviation Summit*. Mountain View, CA, 2010.
  - Royal Aeronautical Society. *Greener by Design: Mitigating the Environmental Impact of Aviation: Opportunities and Priorities*. 2005.
  - Hughes, C. “Geared Turbofan Technology.” In *NASA Green Aviation Summit*. Mountain View CA, 2010.
  - International Civil Aviation Organization. “Report of the Independent Experts on Fuel Burn Reduction Technology Goals.” Paper read at Committee on Aviation Environmental Protection (CAEP) Steering Group Meeting, November 2010, at Toulouse, France.
  - Intergovernmental Panel on Climate Change. “Transport and Its Infrastructure.” In *Climate Change 2007: Mitigation*. Contribution of Working Group III to the Fourth Assessment Report of the Intergovernmental Panel on Climate Change, B. Metz, O R. Davidson, P.R. Bosch, R. Dave, L.A. Meyer, eds. Cambridge and NY: Cambridge University Press, 2007.
  - Jahanmiri, M. *Aircraft Drag Reduction: An Overview*. Goteborg, Sweden, Chalmers University of Technology, 2011.
  - Ko, A.; Mason, W. H.; et al. “A-7 Strut Braced Wing Concept Transonic Wing Design.” Virginia Polytechnic Institute and State University, Blacksburg, VA. Prepared for NASA Langley Research Center, 2002.
  - McCollum, D.; Gould, G.; Greene, D. “GHG Emissions from Aviation and Marine Transportation: Mitigation Potential and Policies.” Pew Center on Global Climate Change, 2009. Available at: <http://www.pewclimate.org/docUploads/aviation-and-marine-report-2009.pdf>.
  - Sabnis, J. “Propulsion System Challenges and Solutions.” NASA Green Aviation Summit, Mountain View, CA, 2010. Available at: [http://www.aeronautics.nasa.gov/pdf/20\\_sabnis\\_green\\_aviation\\_summit.pdf](http://www.aeronautics.nasa.gov/pdf/20_sabnis_green_aviation_summit.pdf).
  - Stollery, P. *ATM Global Environment Efficiency Goals for 2050, Reducing the Impact of Air Traffic Management on Climate Change*. CANSO Environment Work Group, 2008.
  - Viswanath, P. R. “Aircraft Viscous Drag Reduction Using Riblets Progress.” *Aerospace Sciences* (38), 2002; pp. 571-600.
  - Vyas, A. D.; Patel, D. M.; Bertram, K. M. “Transportation Energy Futures Series: Potential for Energy Efficiency Improvement Beyond the Light-Duty-Vehicle Sector.” Prepared for the U.S. Department of Energy by Argonne National Laboratory, Argonne, IL. DOE/GO-102012-3706, 82 pp., 2013.
- <sup>69</sup> Millikin, M. “ASTM Committee Votes to Approve Biojet Fuel in Blends up to 50%.” Green Car Congress, 2011. Available at: <http://www.greencarcongress.com/2011/06/astm-20110610.html>.
- <sup>70</sup> American Apparel Producers Network. “Crowley Completes Harbor Class Tugs Re-Powering Project in LA/Long Beach. 2010. Available at: <http://www.aapnetwork.net/news/Crowley-Completes-Harbor-Class-Tugs-Re-powering-Project-in-LALong-Beach.cfm>.
- Ceccio, S. “Air Lubrication Drag Reduction on Great Lakes Ships.” University of Michigan study for Great Lakes Maritime Institute.
  - ICF International. “Tug/Towboat Emission Reduction Feasibility Study—Draft Final Report.” Prepared for U.S. Environmental Protection Agency, 2009.

- Hazeldine, T.; Pridmore, A.; et al. "EU Transport GHG: Routes to 2050? Technical Options to Reduce GHG for Non-Road Transport Modes." Paper 3. AEA Plc, CE Delft, and TNO paper prepared for Directorate-General Environment, European Commission, 2009.
  - Parsons, M. G.; Kotinis, M. "Refinement of the Ballast-Free Ship Concept—Final Report." Department of Naval Engineering, University of Michigan, prepared for Great Lakes Maritime Institute, 2011. Available at: <http://www.glmri.org/downloads/2010Reports/ParsonsKotinis0910.pdf>.
  - Port Authority of New York and New Jersey. "A Clean Air Strategy Plan for the Port of New York and New Jersey—Final." 2009. Available at: <http://www.panynj.gov/about/pdf/CAS-FINAL.pdf>.
  - Skinner, I. "EU Transport GHG: Routes to 2050? Technical Options for Maritime and Inland Shipping." Briefing at European Commission Stakeholder Meetings, July 2, 2009.
  - Vyas, A. D.; Patel, D. M.; Bertram, K. M. "Transportation Energy Futures Series: Potential for Energy Efficiency Improvement Beyond the Light-Duty-Vehicle Sector." Prepared for the U.S. Department of Energy by Argonne National Laboratory, Argonne, IL. DOE/GO-102012-3706, 2013, pp. 82.
  - Walsh, G. M. "Fuel Management for Tugs Becoming an Increasing Challenging." *Professional Mariner* (106), 2007.
  - Wartsila. *Boosting Energy Efficiency*. Energy Efficiency Catalogue/Ship Power R&D, 2008.
- <sup>71</sup> Barnard, B. "Maersk Buys 10 Super-Sized Containerships." *Journal of Commerce* (February 21), 2011; pp. 1-3.
- Clauss, G. F.; et al. *Simulation of the Operation of Wind-Assisted Cargo Ships*. 102 Hauptversammlung der Schiffbautechnischen Gesellschaft, Berlin, Germany, November 21-23, 2007.
  - deKat, J. O. "Sustainable Shipping: Innovative Solutions." EP Visit Briefing, Innovation Department, Maersk Maritime Technology, January 13, 2011.
  - Det Norske Veritas. "Assessment of Measures to Reduce Future CO<sub>2</sub> Emissions from Shipping, Research and Innovation." Position paper, Hovik, Norway, 2010.
  - International Energy Agency Directorate of Sustainable Energy Policy. *Transport Energy and CO<sub>2</sub>*, 2009.
  - International Maritime Organization. *Study of Greenhouse Gas Emissions from Ships*. 2000.
  - International Maritime Organization. "Second IMO GHG Study 2009." Available at: [http://www5.imo.org/SharePoint/blastDataHelper.asp/data\\_id%3D27795/GHGStudyFINAL.pdf](http://www5.imo.org/SharePoint/blastDataHelper.asp/data_id%3D27795/GHGStudyFINAL.pdf).
  - McCollum, D.; Gould, G.; Greene, D. "GHG Emissions from Aviation and Marine Transportation: Mitigation Potential and Policies." Pew Center on Global Climate Change 2009. Available at: <http://www.pewclimate.org/docUploads/aviation-and-marine-report-2009.pdf>.
  - Pan, B.; et al. "The Reduction of Greenhouse Gas Emissions from Freight Transport by Merging Supply Chains." International Conference on Industrial Engineering and Systems Management (IESM), May 13-15, 2009.
  - Sisson, P. E.; McBride, K. "The Economics of Cold Ironing." *Port Technology International*, October, 2010; pp. 1-4.
  - Vyas, A. D.; Patel, D. M.; Bertram, K. M. "Transportation Energy Futures Series: Potential for Energy Efficiency Improvement Beyond the Light-Duty-Vehicle Sector." Prepared for the U.S. Department of Energy by Argonne National Laboratory, Argonne, IL. DOE/GO-102012-3706. 82 pp. 2013.
- <sup>72</sup> Davis, S. C.; Diegel, S. W.; Boundy, R. G. *Transportation Energy Data Book*. Edition 31 (Tables 2.5 and A-12). Oak Ridge National Laboratory Report ORNL-6987, Oak Ridge, TN, 2012.
- <sup>73</sup> U.S. Energy Information Administration. "About U.S. Natural Gas Pipelines—Transporting Natural Gas." Accessed June 19, 2015: [http://www.eia.gov/pub/oil\\_gas/natural\\_gas/analysis\\_publications/ngpipeline/index.html](http://www.eia.gov/pub/oil_gas/natural_gas/analysis_publications/ngpipeline/index.html).
- U.S. Energy Information Administration. "Natural Gas Compressor Stations on the Interstate Pipeline Network: Developments since 1996." 2007. Available at: [http://www.eia.gov/pub/oil\\_gas/natural\\_gas/analysis\\_publications/ngcompressor/ngcompressor.pdf](http://www.eia.gov/pub/oil_gas/natural_gas/analysis_publications/ngcompressor/ngcompressor.pdf).
  - Vyas, A. D.; Patel, D. M.; Bertram, K. M. "Transportation Energy Futures Series: Potential for Energy Efficiency Improvement Beyond the Light-Duty-Vehicle Sector." Prepared for the U.S. Department of Energy by Argonne National Laboratory, Argonne, IL. DOE/GO-102012-3706. 82 pp. 2013.
- <sup>74</sup> Association of American Railroads. "Railroad Facts" 2013 Edition. 2014.
- <sup>75</sup> Association of American Railroads. "Freight Railroads Help Reduce GHG Emissions." Factsheet, 2011.
- Federal Railroad Administration. "Rail Energy Efficiency Study." 2011.
  - ICF International. "Comparative Evaluation of Rail and Truck Energy Efficiency on Competitive Corridors." Prepared for the Federal Railroad Administration, 2009.
  - Lai, Y.-C.; Barkan, C. P. L.; et al. "Optimizing the Aerodynamic Efficiency of Intermodal Freight Trains." *Transportation Research Part E*: doi:10.1016/j.tre.2007.1005.1011, 2007.
  - Lai, Y.-C. R.; Barkan, C. P. L. "Options for Improving the Energy Efficiency of Intermodal Freight Trains." *Transportation Research Record. Journal of the Transportation Research Board* (1916), 2005; pp. 47-55.

- Vyas, A. D.; Patel, D. M.; Bertram, K. M. "Transportation Energy Futures Series: Potential for Energy Efficiency Improvement Beyond the Light-Duty-Vehicle Sector." Prepared for the U.S. Department of Energy by Argonne National Laboratory, Argonne, IL. DOE/GO-102012-3706. 82 pp. 2013.
- <sup>76</sup> Chester, M.; Horvath, A. "Lifecycle Assessment of High-speed Rail: The Case of California." *Environmental Research Letters*, 5 014003, 2010.
- Chester, M. V.; Ryerson, M.S. "Grand Challenges for High-speed Rail Environmental Assessment in the United States." *Transportation Research Part A* (61), 2014; pp. 15-26.
- Davis, S. C.; Diegel, S. W.; Boundy, R. G. "Transportation Energy Data Book." Edition 33, ORNL-6990, Oak Ridge Tennessee: Oak Ridge National Laboratory. Accessed March 7, 2014: <http://cta.ornl.gov/data/index.shtml>.
- <sup>77</sup> John Deere. "Fairway Mowers." Accessed June 19, 2015: [https://www.deere.com/en\\_INT/products/equipment/fairway\\_mowers/ecut\\_hybrid\\_fairway\\_mowers/7500e\\_8500e\\_8000e/7500e\\_8500e\\_8000e.page](https://www.deere.com/en_INT/products/equipment/fairway_mowers/ecut_hybrid_fairway_mowers/7500e_8500e_8000e/7500e_8500e_8000e.page).
- <sup>78</sup> John Deere. "644k Hybrid Wheel Loader." Accessed June 19, 2015: [https://www.deere.com/en\\_US/products/equipment/wheel\\_loaders/644k\\_hybrid/644k\\_hybrid.page](https://www.deere.com/en_US/products/equipment/wheel_loaders/644k_hybrid/644k_hybrid.page).
- <sup>79</sup> Caterpillar. "Increase Fuel Efficiency with the 336E H Hybrid Excavator." Accessed June 19, 2015: [http://www.cat.com/en\\_US/articles/customer-stories/construction/increase-fuel-efficiencywiththe336ehybridexcavator.html](http://www.cat.com/en_US/articles/customer-stories/construction/increase-fuel-efficiencywiththe336ehybridexcavator.html).
- <sup>80</sup> Vyas, A. D.; Patel, D. M.; Bertram, K. M. "Transportation Energy Futures Series: Potential for Energy Efficiency Improvement Beyond the Light-Duty-Vehicle Sector." Prepared for the U.S. Department of Energy by Argonne National Laboratory, Argonne, IL. DOE/GO-102012-3706. 82 pp. 2013.
- <sup>81</sup> National Highway Traffic Safety Administration. "Preliminary Statement of Policy Concerning Automated Vehicles." Accessed June 19, 2015: [http://www.nhtsa.gov/staticfiles/rulemaking/pdf/Automated\\_Vehicles\\_Policy.pdf](http://www.nhtsa.gov/staticfiles/rulemaking/pdf/Automated_Vehicles_Policy.pdf).
- <sup>82</sup> SAE International. "Taxonomy and Definitions for Terms Related to On-Road Motor Vehicle Automated Driving Systems." 2014.
- <sup>83</sup> Anderson, J. M.; et al. *Autonomous Vehicle Technology: A Guide for Policymakers*. RAND Corporation, ISBN: 978-0-8330-8398-2, 2014.
- <sup>84</sup> Seward, J. "Mobileye NV Gains: Tesla Motors Inc. to Use Multiple Suppliers for Self-Driving Car." *Benzinga.com*, September 8, 2014. Accessed October 2014: <http://www.benzinga.com/analyst-ratings/analyst-color/14/09/4833196/mobileye-nv-gains-tesla-motors-inc-to-use-multiple-suppl#>.
- <sup>85</sup> Brown, A.; Gonder, J.; Repac, B. "An Analysis of Possible Energy Impacts of Automated Vehicles, Road Vehicle Automation." Meyer, G.; Beiker, S., eds. *Lecture Notes in Mobility*. Springer International Publishing, 2014; pp. 137-153. Available at: [http://link.springer.com/chapter/10.1007/978-3-319-05990-7\\_13](http://link.springer.com/chapter/10.1007/978-3-319-05990-7_13).
- MacKenzie, D.; Wadud, Z.; Leiby, P. "First-Order Estimate of Energy Impacts of Automated Vehicles in the United States." Poster presented at the Transportation Research Board Annual Meeting, Washington, DC, 2014. Available at: [http://cta.ornl.gov/TRBenergy/trb\\_documents/2014\\_presentations/697\\_MacKenzie\\_.pdf](http://cta.ornl.gov/TRBenergy/trb_documents/2014_presentations/697_MacKenzie_.pdf).
- Morrow, W. R. III; Greenblatt, J. B.; Sturges, A.; Saxena, S.; Gopal, A. R.; Millstein, D.; Shah, N.; Gilmore, E. A. "Key Factors Influencing Autonomous Vehicles' Energy and Environmental Outcome. Road Vehicle Automation." Meyer, G.; Sven Beiker, S., eds. *Lecture Notes in Mobility*. Springer International Publishing, 2014; pp. 127-135. Available at: [http://link.springer.com/chapter/10.1007%2F978-3-319-05990-7\\_12](http://link.springer.com/chapter/10.1007%2F978-3-319-05990-7_12).
- <sup>86</sup> Lammert, M. P.; et al. "Effect of Platooning on Fuel Consumption of Class 8 Vehicles Over a Range of Speeds, Following Distances, and Mass." 2014. Available at: <http://www.nrel.gov/docs/fy15osti/62348.pdf>.
- <sup>87</sup> National Academy of Sciences. "Overcoming Barriers to Electric-Vehicle Deployment: Interim Report." 2013. Available at: <http://www.nap.edu/catalog/18320/overcoming-barriers-to-electric-vehicle-deployment-interim-report>.
- <sup>88</sup> Vimmerstedt, L.; et al. "Transformative Reduction of Transportation Greenhouse Gas Emissions: Opportunities for Change in Technologies and Systems." 2015. Available at: <http://www.nrel.gov/docs/fy15osti/62943.pdf>.



## Tools for Scientific Discovery and Technology Development

- Investment in basic science research is expanding our understanding of how structure leads to function—from the atomic- and nanoscale to the mesoscale and beyond—in natural systems, and is enabling a transformation from observation to control and design of new systems with properties tailored to meet the requirements of the next generation of energy technologies.
- At the core of this new paradigm is a suite of experimental and computational tools that enable researchers to probe and manipulate matter at unprecedented resolution. The planning and development of these tools is rooted in basic science, but they are critically important for technology development, enabling discoveries that can lead to broad implementation.
- These tools are available through a user facility model that provides merit-based open access for nonproprietary research. Each year, thousands of users leverage the capabilities and staff expertise for their research, while the facilities leverage user expertise toward maintenance, development, and application of the tools in support of the broader community of users.
- The challenges in energy science and technology development increasingly necessitate interdisciplinary collaboration. The multidisciplinary and multi-institutional research centers supported by DOE are designed to integrate basic science and applied research to accelerate development of new and transformative energy technologies.
- Capabilities supported by DOE and the DOE-Office of Science (SC) are enabling the following across science and technology:
  - The X-ray light and neutron sources provide unprecedented access to the structure and dynamics of materials and the molecular-scale basis of chemical reactions. These tools, combined with novel nanoscale synthesis and fabrication techniques, are being used to develop a new era of control science at the mesoscale that will lead to novel materials for energy applications, including batteries, photovoltaics, and catalysts.
  - New technologies for energy and environmental applications based on or inspired by biological systems are enabled by advances in genomic, analytical, and observation tools. These developments are leading to designer plants for biofuel production and new climate models that produce more accurate forecasts for future energy needs.
  - Modeling, simulation, and data analysis using high-performance computers offers researchers the opportunity to simulate complex real-world phenomena, interpret large data sets, and accelerate development of new technology. The next generation of hardware, software, and algorithms offers the opportunity to computationally design complex systems for energy and environmental applications.
- Analysis of the research and development opportunities across the six energy technology chapters shows a crosscutting need for new materials and modeling, simulation, and data analytics. Careful and ongoing strategic planning by DOE-SC supports both of these scientific themes.

# 9

## Enabling Capabilities for Science and Energy

Basic science, including the tools needed to facilitate discovery, expands our understanding of the natural world and forms the foundation for future technology. The current imperative—energy systems that meet our energy security, economic, and environmental challenges—requires advances in energy generation, storage, efficiency, and security that demand a new generation of materials (including biological and bio-inspired materials) that may not be naturally available. However, creating these new materials requires a level of understanding of the relationships between structure and function, and across many spatial scales, which is not yet supported by our understanding of the physical world. Basic scientific research is necessary to fill these knowledge gaps and enable creation of new materials with the specific characteristics needed for next-generation energy technology.

As described in the 2004 National Nanotechnology Initiative<sup>1</sup> workshop report, *Nanoscience Research for Energy Needs*,<sup>2</sup> all elementary steps of energy conversion take place at the atomic and nanoscale. The ability to rationally tailor matter at such scale would enable production of new materials for energy applications, including photovoltaics, electrodes and electrolytes, smart membranes, separators, superconductors, catalysts, fuels, sensors, and piezoelectrics. By extension, tailoring biological materials—from microbes to plants—at the genomic and sub-cellular levels would enable more efficient means of conversion, including those required to produce renewable and sustainable biofuels and bioproducts.

The current challenge in materials science is to understand how nanoscale phenomena translate to properties at the mesoscale and beyond. Quantum mechanics describes atomic, molecular, and nanoscale phenomena, while classical mechanics describes macroscale behavior. The organizing principles governing emergent phenomena at the mesoscale, where classical properties first begin to emerge out of the quantum world, is only now being revealed.<sup>3</sup> As systems grow in size from the nanoscale to the mesoscale, defects, interfaces, and fluctuations emerge that could be manipulated to program the various desired functionalities of materials, including specific thermal, electronic, and mechanical properties at the bulk level. In this way, nanoscale design can result, at the mesoscale and beyond, in the creation of radically new materials, with properties and functionalities that expand upon, or fundamentally differ from, those found in nature.

Analogous to inorganic materials, living systems demonstrate properties and functionalities that go beyond the additive functions of their constituent parts. The challenge for systems biology is to understand how particular changes to metabolic pathways—often stemming from small changes at the genome scale—play out at the level of the whole organism or an entire microbial community. For example, this latter understanding is critical for achieving effective conversion of biomass into biofuels.<sup>4</sup>

Finally, this new energy research agenda is being shaped by dramatic advances in computation. Today's high-performance computers allow complex real-world phenomena to be studied virtually, including phenomena at the nano- and mesoscale, at very high spatial and temporal fidelity, and at a much-accelerated pace. Critically, these tools are giving access to the properties of systems too dangerous to study experimentally, or too costly to develop by trial-and-error.



Taken together, these developments have put science and technology on the threshold of a transformation from observation to control and design of new systems. This paradigm shift is transforming the processes by which new materials and bio-systems are predicted, designed, and created. This revolution represents a convergence of theory, modeling, synthesis, and characterization, and will enable predictive modeling of materials, control of chemistry, and synthetic biology.<sup>5</sup>

The paradigm of “control” and “design” requires a diverse suite of experimental tools for spatial and temporal characterization and computational tools for theory, modeling, and simulation of complex phenomena. Furthermore, the new energy systems that will usher in a low-carbon, high-efficiency, environmentally sustainable future require a strong disciplinary base and sustained support for new scientific discoveries.

For more than a half century, the DOE Office of Science (DOE-SC) and its predecessor organizations have supported fundamental research underpinning the development and improvement of energy production, conversion, transmission, storage, efficiency, and waste mitigation. This investment is manifested in the broad disciplinary support for scientific discovery at universities and DOE national laboratories,<sup>6</sup> as well as in the development and stewardship of the world’s most diverse set of experimental and computational research tools. The federal role in maintaining robust support for scientific discovery is well understood. Perhaps less well known is that the development and construction of these tools, as well as the unique user model that provides open, competitive access regardless of institutional affiliation, is only possible through sustained federal support for these facilities—both in the capital investment to build them and the intellectual investment in the workforce needed to design and operate them. For example, the Spallation Neutron Source (SNS) at Oak Ridge National Laboratory (ORNL) was completed in 2006 after more than five years of construction at a cost of \$1.4 billion. Its development and construction was enabled by collaboration of six DOE national laboratories.<sup>7</sup>

This chapter is a survey of how DOE and DOE-SC support energy technology through investment in basic science research and development of complex and unique experimental and computational capabilities. Planning for and development of the capabilities described in this chapter is rooted in both the opportunities presented by basic science and the enabling tools (or lack thereof) needed by the research community to make discoveries. The science and capabilities described in this chapter are also critically important for technology development, enabling discoveries that can obviate the technical roadblocks to broader implementation.

This chapter describes, at a technically approachable level, the unique capabilities that enable both discovery science and technology research and development (R&D), the open-access and merit-based user facility model by which these capabilities are made available to researchers, and the novel DOE funding mechanisms that bring together scientists and technologists around critical issues in energy and the environment to accelerate the transition from scientific discovery to technology deployment. Additionally, a recent scientific study is described for each class of facility. This collection of cutting-edge science is a small subset of DOE-SC-supported basic research that represents how these tools are being used to enable scientific discovery and how these discoveries are connected to the energy technologies reviewed in this report.

## 9.2 Multidisciplinary, Multiscale Research

The complexity of the scientific problems that must be overcome to realize the energy technologies of the future requires a level of cross-disciplinary insight that is challenging for the single investigator or small research team. In the last decade, DOE has initiated a series of targeted funding opportunities designed to promote this collaborative, multidisciplinary energy science research model. The results of this multi-year effort are the three current research center modalities: 1) the Energy Frontier Research Centers (EFRCs), 2) the Energy Innovation Hubs, and 3) the Bioenergy Research Centers (BRCs). Each has unique structures and modes of operation designed to support their specific research focus.<sup>8</sup> The EFRCs focus on fundamental research,

## Five Grand Challenges for Basic Energy Sciences

- How do we control material properties at the level of electrons?
- How do we design and perfect atom- and energy-efficient synthesis of revolutionary new forms of matter with tailored properties?
- How do remarkable properties of matter emerge from complex correlations of the atomic or electronic constituents and how can we control these properties?
- How can we master energy and information on the nanoscale to create new technologies with capabilities rivaling those of living things?
- How do we characterize and control matter away—especially very far away—from equilibrium?

addressing one or more of the DOE-SC Office of Basic Energy Science (SC-BES) grand challenges (see textbox: *Five Grand Challenges for Basic Energy Sciences*) and basic research needs (see Section 9.2.1). The Hubs and BRCs are large, comprehensive, multidisciplinary research centers that bridge the gap between basic and applied research to each address a single critical national energy need (see Section 9.2.2). The BRCs are large, multi-institutional, multidisciplinary research centers focused on developing the basic science needed to realize commercially viable cellulosic biofuels (see Section 9.2.3). The overarching goal for all of these research centers is to rapidly enable innovative fundamental energy science research that will form the foundation for the energy technologies of the future, thereby supporting the DOE mission in energy, environment, and national security.

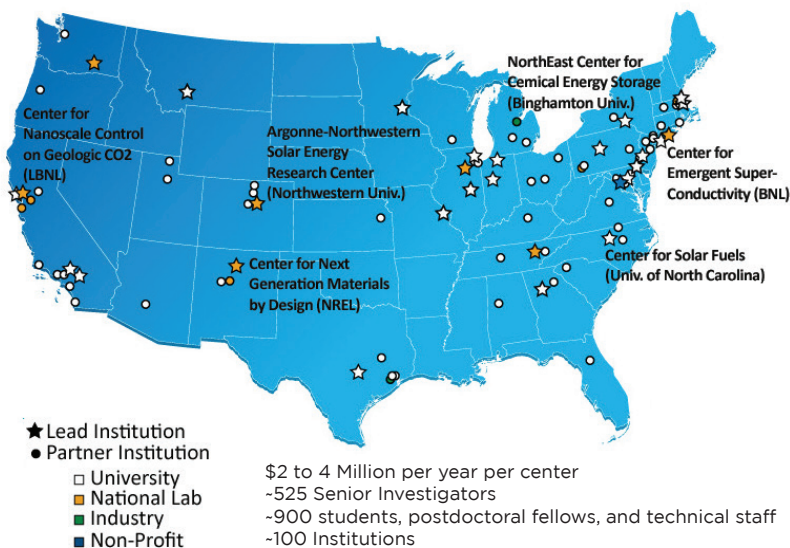
The integrative culture of these research centers is intended to foster the necessary cross-disciplinary collaboration described above, building on a strong disciplinary base built up over the years through sustained investment from DOE, DOE-SC, and other federal agencies.<sup>9</sup> The resulting research partnerships created among universities, DOE national laboratories, nonprofits, and the private sector facilitate knowledge sharing across disciplines so that breakthroughs in one area can quickly be capitalized on and translated to other areas of emphasis, thereby accelerating discovery. This tight integration with DOE national laboratories allows the researchers to leverage the large-scale experimental and computational tools necessary to predict, characterize, and manipulate the behavior of matter at the atomic and molecular scale.

The following sections present more detailed descriptions of the three modalities, including their specific scientific and technical motivations.

### 9.2.1 Energy Frontier Research Centers

The EFRCs are major collaborative research efforts intended to accelerate high-risk, high-reward fundamental research that will provide a strong scientific basis for transformative energy technologies of the future. Their genesis is in the 2007 Basic Energy Sciences Advisory Committee report, *Directing Matter and Energy: Five Challenges for Science and the Imagination*, the culmination of a series of Basic Research Needs workshops sponsored by SC-BES beginning in 2001.<sup>10</sup> The research at each EFRC must address one or more of five interrelated grand challenges<sup>11</sup> that define the roadblocks to progress and the opportunities for transformational discovery (see textbox: *Five Grand Challenges for Basic Energy Sciences*), as well as one of the priority research directions identified in the BRN workshop series.<sup>12</sup>

**Figure 9.1** Locations of Current Energy Frontier Research Centers (EFRC) and Partnering Institutions. The names of a subset of the thirty-two centers are given to show the overlap between EFRC science-drivers and the energy technologies surveyed in this report.



These integrated, multi-investigator centers are tackling some of the toughest scientific challenges hampering advances in energy technologies, including carbon capture and sequestration, predictive modeling of materials, catalysis, and energy storage (see textbox: *Designer Materials for Carbon Capture, Gas Separations, and Catalysis*).<sup>13</sup> The EFRCs are providing an important bridge between basic research and energy technologies through partnerships created between universities, DOE national laboratories, and the private sector, and through the complementarity with other research activities funded by DOE and with the larger

energy research community.<sup>14</sup> Figure 9.1 shows the locations of the current thirty-two EFRCs and names six that highlight the overlap between EFRC science-drivers and the energy technologies surveyed in this report.

EFRCs accelerate energy science by providing an environment that encourages high-risk, high-reward research that would be challenging to support at the single investigator level; integrating synthesis, characterization, theory, and computation; developing new, innovative experimental and theoretical tools that illuminate fundamental processes in unprecedented detail; and training an interdisciplinary community of energy-focused scientists.

### 9.2.2 Energy Innovation Hubs

The four DOE Energy Innovation Hubs<sup>16</sup> focus on overcoming critical scientific barriers that, if realized, could lead to transformative energy technologies. Through the synergistic efforts of large teams of researchers across multiple disciplines and from multiple institutions, including universities, DOE national laboratories, the private sector, and nonprofits, the hubs aim to accelerate the pace of both scientific discovery and technology development and deployment. The ambitious high-risk, high-reward R&D goals within each hub have the potential to provide the breakthroughs needed for revolutionary changes in how energy is produced and used.

The hub model is designed to integrate basic science with applied research and technology development through close links within the hub organization. This organization is inspired by historical research laboratories such as the Lincoln Laboratories at Massachusetts Institute of Technology and the AT&T Bell Laboratories—multidisciplinary research laboratories that conducted groundbreaking science and produced transformative technologies. Furthermore, the hubs have been instilled with a sense of urgency to deliver energy technology solutions and develop deployable new technologies. The hubs are therefore funded at a level to enable this new type of collaboration and strategic coordination between scientists and technologists that is required to fulfill the hubs' broader science and technology missions.<sup>17</sup> Within this model, each hub is unique in how it approaches its goals, which are dictated by the current state of the technology and its associated industry.<sup>18</sup>



## Designer Materials for Carbon Capture, Gas Separations, and Catalysis

The ability to efficiently and controllably separate and store different molecules is critically important to a broad range of energy-relevant technologies, including carbon capture, hydrogen storage, chemical sensors, hydrocarbon separations, and chemical production. While possible today, the traditional approaches are energy intensive and therefore costly.

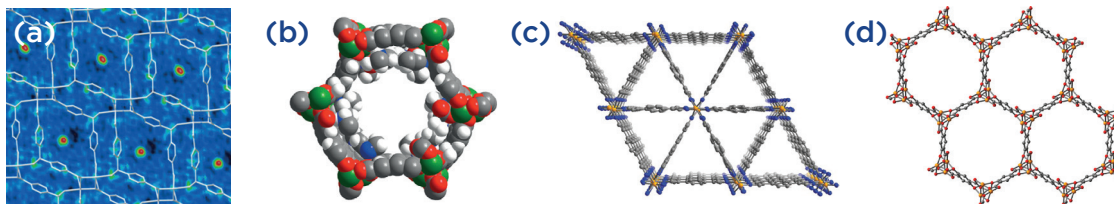
In the last decade, a great deal of scientific and technological attention has been paid to a class of materials known as metal-organic frameworks (MOFs). These highly porous materials typically consist of an array of metallic ion nodes surrounded by organic “linker” molecules, and have extremely large internal surface areas, providing numerous sites for interactions and transport of guest molecules within the MOF pores.

DOE-SC is supporting fundamental scientific research to design, synthesize, functionalize, and characterize MOFs, including work in the core program and the EFRCs. The research to date has resulted in the discovery of new MOFs for the capture of carbon dioxide ( $\text{CO}_2$ ), the separation and storage of hydrogen, the separation of hydrocarbons based on shape, and chemical synthesis such as the conversion of ethane to ethanol (Figure 9.2). Researchers are also working on designing MOFs to withstand the harsh environmental conditions that exist in many potential applications.

Given the very large number of known and possible MOFs, exploring them all experimentally is inefficient. In recent years, significant research has focused on predictive modeling as a means to identify promising candidates for a particular functionality. Those efforts can then guide the targeted synthesis and characterization of a more limited number of materials. The diversity of MOFs is a challenge and an opportunity, both scientifically and technologically. Today’s research holds the promise for a future in which MOFs with tailored multifunctionality are designed on computers and then synthesized for use in a diverse array of energy technologies.

**Figure 9.2** The structure of four representative MOFs demonstrates the large diversity within this class of materials. Experiments and computations confirm that these MOFs capture  $\text{CO}_2$  (a, b) and separate hydrocarbons (c, d). MOF (d) has also been shown to convert ethane to ethanol.<sup>15</sup>

Credit: (a) From Plonka, A. M., Banerjee, D., Woerner, W. R., Zhang, Z., Nijem, N., Chabal, Y. J., Li, J. and Parise, J. B. Mechanism of Carbon Dioxide Adsorption in a Highly Selective Coordination Network Supported by Direct Structural Evidence. *Angewandte Chemie International Edition*, 52, 1692-1695 (2013). Reprinted with permission from John Wiley and Sons. (b) Reprinted by permission from Macmillan Publishers Ltd: *Nature* (519), 2015. (c) From Herm, Zoey R; Wiers, Brian M.; Mason, Jarad A; van Baten, Jasper M; Hudson, Matthew R; Zajdel, Pawel; Brown, Craig M; Masciocchi, Norberto; Krishna, Rajamani; and Long, Jeffrey R. Separation of Hexane Isomers in a Metal-Organic Framework with Triangular Channels. *Science*, 340, 960-964 (2013). Reprinted with permission from AAAS. (d) Reprinted by permission from Macmillan Publishers Ltd: *Nature Chemistry* (6), 2014.





The two hubs funded and managed by DOE-SC focus on two challenges in energy: 1) fuels from sunlight and 2) batteries and energy storage. The first hub, the Joint Center for Artificial Photosynthesis (JCAP), aims to demonstrate a scalable, manufacturable solar-fuels generator using Earth-abundant elements that, with no wires, robustly produces fuel from the sun ten times more efficiently than (current) crops (see textbox: *Protected Semiconductors for Solar Fuel Production: A Role for Imperfection*).<sup>19</sup> The primary goal of the second hub, the Joint Center for Energy Storage Research (JCESR), is to enable next-generation batteries (“beyond lithium-ion”) for transportation and the electrical grid that scale to five times the energy density at one-fifth the cost relative to a 2011 baseline battery technology.<sup>20</sup>

A third hub, the Consortium for the Advanced Simulation of Light Water Reactors (CASL), managed by the DOE Office of Nuclear Energy (DOE-NE), is developing modeling and simulation tools that will make it possible to predict the behavior of phenomena that define the operational and safety performance of light water reactors (see also Section 9.6.3).<sup>21</sup> These tools have the potential to accelerate the research, development, and demonstration (RD&D) of new nuclear reactor technology. The newest hub, the Critical Materials Institute (CMI), is managed by the DOE Office of Energy Efficiency and Renewable Energy (DOE-EERE). Its mission is to assure supply chains for the rare earth materials critical to clean energy technologies, including strong permanent magnets and lighting phosphors.<sup>22</sup> CMI is fulfilling this mission by developing at least one technology for industry in its first five years in each of three related areas: materials production, waste reduction, and critical materials substitutes.<sup>23</sup>

### 9.2.3 Bioenergy Research Centers

The BRC Program<sup>25</sup> was established in 2007 by the DOE-SC Biological and Environmental Research (SC-BER) program to accelerate transformational breakthroughs in the basic science needed to develop the cost-effective, sustainable technologies necessary to make cellulosic biofuels commercially viable on a national scale.<sup>26</sup> The three BRCs are multi-institutional, multidisciplinary, and collaborative efforts engaging the universities, DOE national laboratories, the private sector, and nonprofits. They are funded on a large scale<sup>27</sup> to enable research on the entire pathway from bioenergy crop to biofuel production. The three BRCs focus on basic research, pursuing a range of high-risk, high-return approaches to cost effectively produce biofuels and bioproducts from renewable biomass.<sup>28</sup> Additionally, the BRCs track the development of intellectual property to facilitate the transfer of basic science discoveries from the laboratory to the private sector, thereby enabling the translation of their fundamental research advances into the market place.<sup>29</sup>

BRC researchers are taking a multifaceted approach to addressing three grand challenges for cost-effective, sustainable biofuels production. These three grand challenges are encapsulated by the three main facets of the BRC research agenda: 1) create new energy crops, 2) develop new methods for deconstructing lignocellulosic material into chemical building blocks, and 3) insert new metabolic pathways into microbial hosts to increase the production of ethanol and other advanced hydrocarbon fuels that can directly replace petroleum-based fuels such as gasoline on a “drop-in” basis (see textbox: *Improving Biofuel Production through Engineered Inhibitor Tolerance*). Research at the BRCs and in the biofuels community at large is supported and accelerated by continuing development of novel enabling technologies; notably, high-throughput genomic and metabolic screening, synthetic biology, and computational modeling for predicting the effects of genetic manipulation.<sup>30</sup>

## 9.3 DOE-Supported Research Facilities for Science and Technology RD&D

User facilities are a core component of the DOE-SC mission and an important piece of the broader DOE mission (Table 9.1). Such facilities provide state-of-the-art experimental and/or computational resources to their respective research communities that would be prohibitively expensive to develop, build, and operate by a university, private sector, or nonprofit laboratory. Furthermore, the user facility access model enables the DOE national laboratory complex to bring thousands of outside researchers on-site every year where they can

leverage the unique tools and staff expertise for basic science and energy technology RD&D<sup>33</sup> (as well as other areas such as health science and national security) and where they can lend their technical expertise toward the maintenance, development, and application of these tools in support of the broader scientific community.<sup>34</sup>

## Protected Semiconductors for Solar Fuel Production: A Role for Imperfection

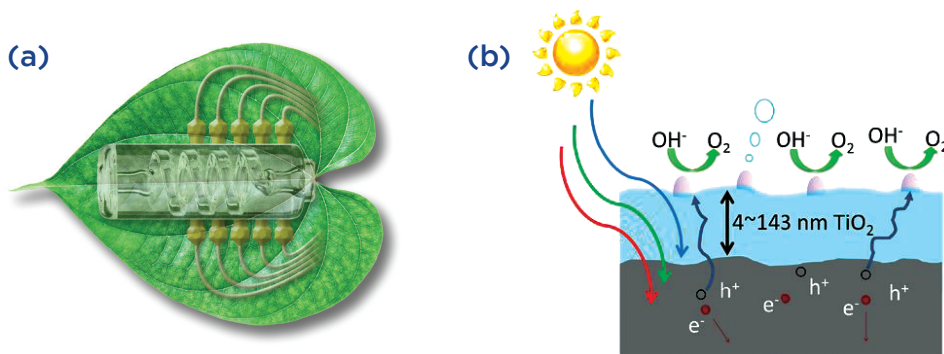
The availability of a solar device that can convert light directly into energy-rich fuels instead of electricity would revolutionize our ability to store energy from sunlight (Figure 9.3a). Given previous investments in developing light-absorbing semiconductors for photovoltaics, it would be advantageous to adapt common photovoltaic materials like silicon and gallium arsenide for use in such a solar fuels generator. Unfortunately, these materials degrade rapidly when submerged in the aqueous solutions that are required to produce fuels.

JCAP scientists have recently discovered a method to protect common semiconductors from corrosion in water while still allowing them to absorb light and generate charge for fuel production (Figure 9.3b). Protective coatings that are sufficiently thick to prevent corrosion typically block incident light or prevent electrical charges produced by the semiconductor from reaching the reactive surface. JCAP researchers used a process called atomic layer deposition to produce a transparent but electrically conductive coating of titanium dioxide on light-absorbing semiconductors. The coating contains imperfections enabling the conduction of charge. By positioning a chemical catalyst on the water-exposed surface of the protective coating, light absorption by the semiconductor and subsequent charge transfer to the catalyst can drive reactions needed for fuel formation.

This strategy of making use of imperfections in the protective coating is an important new tool that could significantly expand the list of candidate materials suitable for use in the solar-driven production of fuels.

**Figure 9.3** (a) A solar fuel-generating device would mimic the natural photosynthesis carried out in a leaf, capturing solar energy and converting it into chemical energy stored as a liquid fuel. (b) The titanium dioxide ( $\text{TiO}_2$ ) protective layer stabilizes the silicon photoanode against corrosion so that hydroxide ions ( $\text{OH}^-$ ) in the electrolyte can be continuously oxidized to oxygen gas ( $\text{O}_2$ ).<sup>24</sup>

Credit: (b) From Hu, Shu; Shaner, Matthew R.; Beardsless, Joseph A.; Lichterman, Michael; Brunshwig, Bruce S.; and Lewis, Nathan S. Amorphous  $\text{TiO}_2$  coatings stabilize Si, GaAs, and GaP photoanodes for efficient water oxidation. *Science*, 344, 1005-1009 (2014). Reprinted with permission from American Association for the Advancement of Science.



## Improving Biofuel Production through Engineered Inhibitor Tolerance

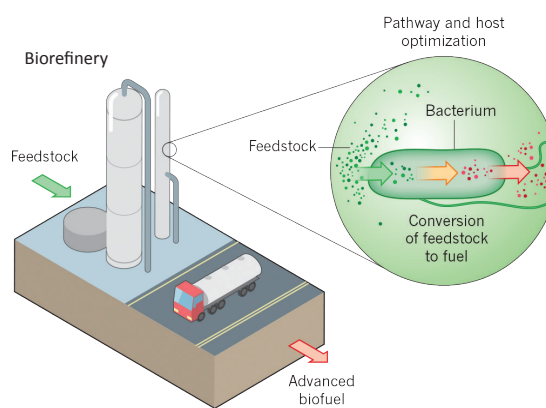
The use of microbial host platforms such as *Escherichia coli* (*E. coli*) for the production of bulk chemicals and fuels is now a focus of many biotechnology efforts (Figure 9.4). Many of these compounds are inherently toxic to the host microbe, which in turn places a limit on production volume. In order to achieve economically viable production levels, it is necessary to engineer increased output from the production strains while improving tolerance to the desired compounds.

Researchers at the DOE Joint Bioenergy Institute at Lawrence Berkeley National Laboratory (LBNL) discovered an effective method of host engineering for the production of short-chain alcohols. Using systems biology data, the researchers identified forty genes in *E. coli* that show increased activity in response to exogenous isopentenol. This overexpression of several of these candidate genes improved *E. coli* tolerance to the exogenously added isopentenol. Those genes conferring isopentenol tolerance phenotypes belonged to diverse functional groups, including oxidative stress response, general stress response, heat shock-related response, and transport.

To determine if these genes could also improve isopentenol production, researchers co-expressed the tolerance-enhancing genes with an isopentenol production pathway to induce expression. The data show that expression of six of the eight candidate genes improved the production of isopentenol in *E. coli*, with the methionine biosynthesis regulator MetR improving isopentenol production the most. Additionally, expression of MdlB, a transporter protein, facilitated a 12% improvement in isopentenol production. This is believed to be the first example of a transporter being used to improve production of a short-chain alcohol, and provides a valuable new avenue for host engineering in biogasoline production. These results demonstrate that microbial tolerance engineering using transcriptomics<sup>31</sup> data can also identify targets that improve production of biofuels and bioproducts.

**Figure 9.4** Optimization of microbial metabolism leads to enhanced production of advanced biofuels such as isopentenol.<sup>32</sup>

Credit: Reprinted by permission from Macmillan Publishers Ltd: *Nature* (488), 2012.



All DOE user facilities are open access,<sup>35</sup> with allocation of time determined by merit-based peer review of user proposals. The submitted proposals are reviewed irrespective of nationality or institutional affiliation, enabling domestic and international scientists from universities, federal laboratories, the private sector, and nonprofits to use the unique capabilities and sophisticated instrumentation. User fees are not charged for nonproprietary research if the user intends to publish the results in peer-reviewed literature; full cost-recovery is required for proprietary research.

User facilities typically are constructed to meet broad mission needs, enabling a range of scientific and technical research, characterization, and analysis.<sup>36</sup> The X-ray light and neutron sources, the nanoscale science research centers, and the Environmental Molecular Science Laboratory, for example, each serve a community of users with representation from across the physical and biological sciences.<sup>37</sup> In contrast, the DOE-SC user facilities such as the Argonne Tandem Linac Accelerator, the Fermilab Accelerator Complex, or the National Spherical Torus Experiment are designed to meet the mission needs of a specific scientific community.

In addition to the twenty-eight DOE-SC user facilities, DOE-EERE, and the DOE-NE support designated user facilities that serve the RD&D needs of specific energy technology communities.

- The Energy Systems Integration Facility at the National Renewable Energy Laboratory (NREL) provides RD&D capabilities for integration of clean energy technologies with the grid. The available capabilities fall into four categories: 1) systems integration, 2) prototype and component development, 3) manufacturing and material diagnostics, and 4) high-performance computing (HPC) and analytics.<sup>38</sup>
- The Nuclear Science User Facilities (NSUF) at Idaho National Laboratory (INL) is the only nuclear energy-designated user facility. It provides users with access to the Advanced Test Reactor, a research-scale nuclear reactor providing large-volume, high-flux neutron irradiation in a prototype environment. NSUF also provides post-irradiation examination facilities as well as beamline capabilities at affiliated partner institutions.<sup>39</sup>

Three user facilities established at ORNL support energy technology RD&D by providing access to state-of-the-art technology and expertise, as well as collaborative access to the DOE-SC experimental and computational user facilities at ORNL (see Table 9.1).

- The Manufacturing Demonstration Facility (MDF) enables rapid development of novel manufacturing techniques that have the potential to produce energy-efficient, competitively priced, high-quality products. MDF capabilities support RD&D in additive manufacturing, composite materials, and carbon fiber, as well as complementary manufacturing research, including lightweight metals processing, roll-to-roll processing, and low-temperature materials synthesis.<sup>40,41</sup>
- The Buildings Technology Research and Integration Center supports technology RD&D to improve efficiency and environmental compatibility throughout the built environment. This broad support for technology development is organized into four Centers of Excellence, three focused on R&D (building envelope, building equipment, and system/building integration), and one on deployment (building technologies deployment). The three Centers of Excellence focused on R&D provide users with unique experimental capabilities to develop and evaluate new technology from concept to commercialization.<sup>42</sup>
- The National Transportation Research Center (NTRC) is supporting industry, academia, and other federal agencies in developing advanced transportation technologies to improve fuel economy, reduce emissions, and address transportation system issues. NTRC provides users with access to a comprehensive suite of experimental laboratories; ORNL supercomputing facilities; and distinctive analysis, diagnostic, and visualization capabilities.<sup>43</sup> NTRC supports the ORNL Sustainable Transportation Program, which is pursuing an “all of the above” transportation research strategy on behalf of DOE.<sup>44</sup>

Finally, the Wireless National User Facility at INL provides researchers with the tools and infrastructure to perform RD&D for infrastructure security, communications interoperability, spectrum utilization, and the reliability of wireless technologies. This work is supported by multiple federal agencies, including DOE.<sup>45</sup>



**Table 9.1** Current List of DOE Designated User Facilities<sup>46</sup>

User facility	Location	Description	Program	Section
Wireless National User Facility (WNUF)	Idaho National Laboratory	Wireless communication RD&D	Multiple	9.3
Energy Systems Integration Facility (ESIF)	National Renewable Energy Laboratory	Energy systems RD&D	DOE-EERE	9.3
Nuclear Science User Facilities (NSUF)	Idaho National Laboratory	Nuclear energy R&D	DOE-NE	9.3
Manufacturing Demonstration Facility (MDF)	Oak Ridge National Laboratory	Advanced manufacturing technology RD&D	DOE-EERE	9.3
National Transportation Research Center (NTRC)	Oak Ridge National Laboratory	Vehicle technology R&D	DOE-EERE	9.3
Building Technologies Research Integration Center (BTRIC)	Oak Ridge National Laboratory	Energy-efficient building technology RD&D	DOE-EERE	9.3
Linac Coherent Light Source (LCLS)	SLAC National Accelerator Laboratory	X-ray free electron laser	SC-BES	9.4.1
Stanford Synchrotron Radiation Light Source (SSRL)	SLAC National Accelerator Laboratory	X-ray synchrotron light source	SC-BES	9.4.1
Advanced Light Source (ALS)	Lawrence Berkeley National Laboratory	X-ray synchrotron light source	SC-BES	9.4.1
Advanced Photon Source (APS)	Argonne National Laboratory	X-ray synchrotron light source	SC-BES	9.4.1
National Synchrotron Light Source-II (NSLS-II)	Brookhaven National Laboratory	X-ray synchrotron light source	SC-BES	9.4.1
Spallation Neutron Source (SNS)	Oak Ridge National Laboratory	Pulsed neutron source	SC-BES	9.4.2
High Flux Isotope Reactor (HFIR)	Oak Ridge National Laboratory	Continuous neutron source	SC-BES	9.4.2
Center for Integrated Nanotechnologies (CINT)	Los Alamos and Sandia National Laboratories	Nanoscale science	SC-BES	9.4.3
Center for Nanophase Materials Sciences (CNMS)	Oak Ridge National Laboratory	Nanoscale science	SC-BES	9.4.3
The Molecular Foundry (TMF)	Lawrence Berkeley National Laboratory	Nanoscale science	SC-BES	9.4.3
Center for Nanoscale Materials (CNM)	Argonne National Laboratory	Nanoscale science	SC-BES	9.4.3
Center for Functional Nanomaterials (CFN)	Brookhaven National Laboratory	Nanoscale science	SC-BES	9.4.3
Joint Genome Institute (JGI)	Lawrence Berkeley National Laboratory	High-throughput DNA sequencing and analysis	SC-BER	9.5.1

**Table 9.1** Current List of DOE Designated User Facilities (continued)

User facility	Location	Description	Program	Section
Environmental Molecular Sciences Laboratory (EMSL)	Pacific Northwest National Laboratory	Experimental and computational molecular science	SC-BER	9.5.2
Atmospheric Radiation Measurement Climate Research Facility (ARM)	Multiple Sites	Climate observation	SC-BER	9.5.3
National Energy Research Scientific Computing Center (NERSC)	Lawrence Berkeley National Laboratory	High-performance computing	SC-ASCR	9.6.1
Oak Ridge Leadership Computing Facility (OLCF)	Oak Ridge National Laboratory	High-performance computing	SC-ASCR	9.6.1
Argonne Leadership Computing Facility (ALCF)	Argonne National Laboratory	High-performance computing	SC-ASCR	9.6.1
Energy Sciences Network (ESNet)	Lawrence Berkeley National Laboratory	High-performance network for scientific research	SC-ASCR	9.6.2
Facility for Advanced Accelerator Experimental Tests (FACET)	SLAC National Accelerator Laboratory	Linear-accelerator for beam-driven plasma wakefield R&D	SC-HEP	9.7.1
Fermilab Accelerator Complex	Fermi National Accelerator Laboratory	Particle accelerators for HEP research	SC-HEP	9.7.1
Accelerator Test Facility (ATF)	Brookhaven National Laboratory	Laser and electron beams for advanced accelerator R&D	SC-HEP	9.7.1
Continuous Electron Beam Accelerator Facility (CEBAF)	Thomas Jefferson National Accelerator Laboratory	Linear accelerators for QCD research	SC-NP	9.7.1
Relativistic Heavy Ion Collider (RHIC)	Brookhaven National Laboratory	Circular collider for heavy ion research	SC-NP	9.7.1
Argonne Tandem Linac Accelerator System (ATLAS)	Argonne National Laboratory	Superconducting linear accelerator for nuclear structure research	SC-NP	9.7.1
DIII-D Tokamak (DIII-D)	General Atomics	Fusion energy R&D	SC-FES	9.7.4
National Spherical Torus Experiment (NSTX-U)	Princeton Plasma Physics Laboratory	Fusion energy R&D	SC-FES	9.7.4
Alcator C-Mod <sup>47</sup>	Massachusetts Institute of Technology	Fusion energy R&D	SC-FES	9.7.4



The DOE energy technology offices support many unique, specialized facilities at DOE national laboratories (Table 9.2). These shared R&D facilities include a broad spectrum of DOE laboratory assets, such as technology benchmarking test beds (sometimes called “test facilities”),<sup>49</sup> large-scale collaborative R&D centers (see textbox: *Detecting an Elusive Combustion Intermediate*),<sup>50</sup> and specialized materials processing capabilities,<sup>51</sup> among many others.<sup>52</sup> Access to these facilities is made available to external users through collaborative research agreements.<sup>53</sup>

**Table 9.2** A Subset of More Than One Hundred Shared R&D Facilities Currently Operating at DOE National Laboratories. Each of the facilities in the table conducts R&D relevant to the energy technologies described in this report.

Shared R&D facility	Laboratory <sup>48</sup>
Materials Preparation Center	The Ames Laboratory
Materials Engineering Research Center	Argonne National Laboratory
Transportation Research and Analysis Computing Center	Argonne National Laboratory
Northeast Solar Energy Research Center	Brookhaven National Laboratory
Magnet Systems	Fermi National Accelerator Laboratory
Biomass Feedstock National User Facility	Idaho National Laboratory
CalCharge Battery Laboratory	Lawrence Berkeley National Laboratory
FLEXLAB	Lawrence Berkeley National Laboratory
Fuels Processing Laboratory	National Energy Technology Laboratory
Solar Energy Research Facility	National Renewable Energy Laboratory
High Temperature Materials Laboratory	Oak Ridge National Laboratory
Applied Process Engineering Laboratory	Pacific Northwest National Laboratory
Combustion Research Facility	Sandia National Laboratories

### 9.4 Understanding and Controlling Matter: From the Atomic- to the Mesoscale

The twentieth century witnessed revolutionary advances in key areas of basic science underpinning energy technologies, bringing remarkable discoveries such as high-temperature superconductors that conduct electricity with no loss, carbon nanotubes that have a strength-to-weight ratio more than two orders of magnitude greater than steel, and a host of other dramatic developments. Behind these discoveries are extraordinary advances in observation and characterization afforded by today’s large X-ray light and neutron sources and a wide range of other sophisticated instrumentation. These tools are providing unprecedented access to the world of atoms and molecules, enabling us to view the atomic-scale structure and dynamics of materials and the molecular-scale basis of chemical processes as never before. This has paved the way for manipulating materials at the nanoscale and the mesoscale to create new tailored functionalities.

The fundamental tenet of materials research is that structure determines function. The practical corollary that converts materials research from an intellectual exercise into a foundation of our modern technology-driven economy is that structure can be manipulated to construct materials with desired properties and behaviors.



## Detecting an Elusive Combustion Intermediate

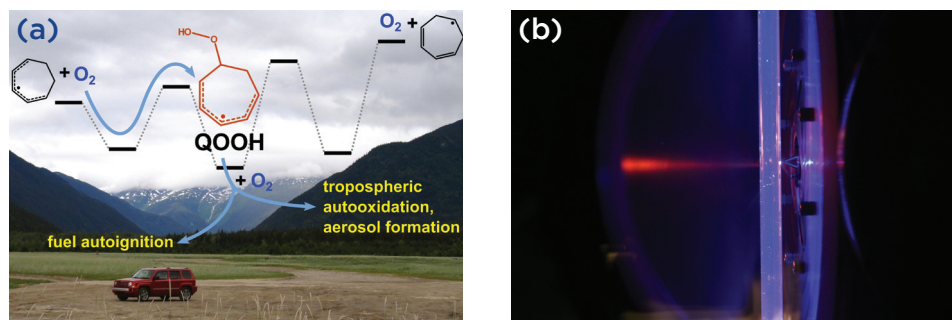
The conversion of organic compounds in Earth's troposphere and the auto-ignition of fuel in internal combustion engines are governed by a surprisingly similar set of reactive intermediates—radicals. Radicals are highly reactive chemical species that have unpaired valence electrons. The presence of radicals leads to the destruction of the ozone layer in the atmosphere and “knocking” in combustion engines.

In combustion engines, a specific class of radicals, called hydroperoxyalkyl radicals and denoted “QOOH,” are so short-lived that they are only present in minute quantities and had never been directly detected by experiment. Scientists at Sandia National Laboratories' (SNL) Combustion Research Facility reported in early 2015 direct observation and kinetics measurements of a QOOH intermediate. The path to success was to give the radical a longer life to make its detection easier. The scientists selected a particular species of QOOH radical, where “Q” is a ring of seven carbon atoms (Figure 9.5), that was resonance stabilized (i.e., the electrons were delocalized due to superposition of their wave functions). Simultaneous spectroscopic characterization of QOOH and direct measurement of its reaction kinetics with molecular oxygen was achieved through photoionization mass spectrometry experiments at the Advanced Light Source (ALS) at LBNL. When comparing the reaction of the non-stabilized and resonance stabilized radicals with molecular oxygen, it was determined that the resonance stabilized radical reacts 1,000 times slower.

Decades of previous research had provided evidence that the QOOH radical was a key element in the network of ignition chemistry reactions. The new experimental data from this study can be used to improve the fidelity of models used by engine manufacturers to create cleaner and more efficient cars and trucks.

**Figure 9.5** (a) Formation and destruction of the resonance stabilized QOOH ( $c\text{-C}_7\text{H}_9\text{O}_2$ ) radical intermediate. (b) The photoionization mass spectrometry apparatus at the ALS used to detect the short-lived QOOH radical.<sup>54</sup>

Credit: (b) Sandia National Laboratories



As introduced above, a suite of experimental user facilities supported by SC-BES—X-ray light sources, neutron sources, and nanoscale science research centers—are providing researchers with the capabilities necessary to probe the fundamental properties of materials and, subsequently, to manipulate those properties through novel nano- and mesoscale synthesis techniques. The possibilities for the development of novel materials to



revolutionize energy technologies are manifold. New generations of electrodes for batteries and fuel cells are being designed to promote the coordinated motion of electrons, ions, and gases and to maximize efficiency and energy density.<sup>55</sup> Mesoporous membranes with defined charge and chemical profiles lining the pores can be designed to separate carbon dioxide, purify water, and catalyze chemical reactions.<sup>56</sup>

The twelve SC-BES user facilities support the basic and applied research activities of thousands of researchers each year from universities, DOE national laboratories, the private sector, and nonprofits. During fiscal year (FY) 2014, the facilities supported more than 15,000 users from many science and technology disciplines, including chemistry, physics, geology, materials science, environmental science, biology, and a wide range of engineering fields. These facilities make possible experimental studies that cannot be conducted in ordinary laboratories, enabling leading-edge research that benefits from a merging of ideas and techniques from different disciplines.

### 9.4.1 X-ray Light Sources

The laws of physics dictate that it is only possible to “see” objects and structures larger than the wavelength of light used to illuminate them. To probe the atomic and molecular structure of any object, we must use substitutes for visible light, probes that have wavelengths comparable to the distances between the atoms under investigation. X-rays are an essential tool for studying the structure of matter and have long been used to peer into dense material through which visible light cannot penetrate. SC-BES is the premier supporter of X-ray science in the United States and has pioneered the development of virtually all of the instruments and techniques used for research at the light sources.

BES light sources provide open user access to a variety of powerful X-ray probes. The core characteristics of the X-ray light sources make them indispensable tools for the exploration of matter.<sup>57</sup> Synchrotron radiation is characterized by its continuous spectrum, high brilliance, tunability, polarizability, high spatial and temporal coherence, and pulsed incidence. These versatile light sources provide researchers with light at a range of wavelengths capable of probing material structures—at length scales from individual atoms and molecules to biological cells to macroscopic structures. They are important tools for research in materials science, physical and chemical sciences, meteorology, geosciences, environmental sciences, biosciences, medical sciences, and pharmaceutical sciences.

Five X-ray light source scientific user facilities are in operation; four are storage ring-based sources: the ALS at LBNL, the Advanced Photon Source (APS) at Argonne National Laboratory (ANL), the National Synchrotron Light Source-II (NSLS-II) at Brookhaven National Laboratory (BNL), and the Stanford Synchrotron Radiation Lightsource (SSRL) at SLAC National Accelerator Laboratory (SLAC). The fifth facility, the Linac Coherent Light Source (LCLS) at SLAC, is a hard X-ray free electron laser FEL capable of ultrafast, ultra-bright X-ray pulses (see textbox: *Traversing a Catalytic Pathway in Femtosecond Timesteps*). The newly constructed NSLS-II, which started operation in FY 2015, is the world’s brightest storage ring-based light source in the medium-energy range (2–10 kiloelectron Volts [keV]). This tool is giving users unprecedented capabilities for X-ray imaging of energy systems under operating conditions and in real time. In addition to the capabilities described above for LCLS and NSLS-II, the APS, as a hard X-ray source (photon energies above 5–10 keV), emphasizes X-ray scattering. The ALS, specializing in soft X-ray science (photon energies less than approximately 5 keV), emphasizes imaging and spectroscopy in the soft X-ray region. Finally, the SSRL predominantly has beamlines dedicated to X-ray scattering and spectroscopy. Generally, each facility provides core experimental techniques to its user base while emphasizing specific capabilities based on the technical specifications of the facility.<sup>58</sup>

The capabilities of the X-ray light sources have allowed researchers to make incredible scientific discoveries important to both basic and applied energy sciences. The results include real-time structural studies on lithium batteries,<sup>59</sup> imaging of fuel sprays to improve combustion engine efficiency,<sup>60</sup> and mapping the

## Traversing a Catalytic Reaction Pathway in Femtosecond Steps

Catalysts are species that alter the pathway of a chemical reaction and lower the energy required to form the desired products. For example, the catalytic conversion of atmospheric nitrogen to ammonia is necessary for fertilizer production that supports agriculture worldwide.

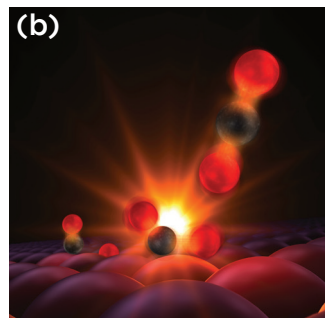
For over a century, scientists have developed theories to predict how chemical species react to form new molecules. Recently, accurate predictions of the rates at which catalytic reactions occur have become accessible, but only for the most elementary reactions and only using idealized catalysts. Experiments have observed chemical bond rupture and formation on catalytic surfaces before and after the event, but not while they occur. By combining theory and experiment, researchers at SLAC National Accelerator Laboratory have now revealed the details of such events by combining ultrafast optical and X-ray laser pulses.

Researchers studied carbon monoxide (CO) oxidation, the same reaction that neutralizes CO from car exhaust. This reaction is also relevant to the conversion of fossil fuels and biofuels into hydrogen gas, a common chemical feedstock and reactant for fuel cells. Following excitation by an optical laser pulse, the ultrafast X-ray pulses available from the LCLS at SLAC—the world's first hard X-ray free electron laser—were used to detect the vibrations of CO and oxygen bound to a ruthenium (Ru) catalyst surface as they reacted to create a new chemical bond and form CO<sub>2</sub>. The entire sequence lasts about a picosecond (10<sup>-12</sup>seconds). Observing the elementary steps of the reaction therefore required making measurements in femtosecond (10<sup>-15</sup> seconds) steps. Direct measurement of these elementary reaction steps was made possible by combining the ultrafast capabilities of the LCLS with the most advanced theories of chemical bonding and reaction.

In general, the detailed understanding of elementary reaction steps—the holy grail of chemistry—that will be enabled by the LCLS will help realize catalyst development by design. This has the potential to dramatically accelerate the development of new catalysts with specific properties.

**Figure 9.6** (a) The 132-meter LCLS undulator hall. (b) Artists concept showing a CO molecule, left, made of a carbon atom (black) and an oxygen atom (red), reacting with an oxygen atom (to the right of CO). The surface of a Ru catalyst holds them in proximity to facilitate their reaction. When excited with an optical laser pulse, the reactants vibrate and the carbon atom forms a transitional bond with the oxygen (center). The resulting CO<sub>2</sub> molecule detaches and moves into the gas phase (upper right).<sup>66</sup>

Credit: SLAC National Accelerator Laboratory





process-structure-property relationships in copper indium gallium selenide, the active material in the Dow Powerhouse™ Solar Shingle.<sup>61</sup> In addition, four of the Nobel Prizes in chemistry from the last decade have been awarded to researchers based, in part, on protein structures determined with data from SC-BES light sources.<sup>62</sup>

The SC-BES light sources will continue to maintain scientific competitiveness and push the boundaries of experimental X-ray science in the years to come.<sup>63</sup> Currently, both the LCLS and APS are in the process of upgrading to extend their capabilities to higher photon energy, brighter beams, and, specific to the APS upgrade, to a far higher degree of beam coherence. These dramatic steps in X-ray beam parameters will allow interfaces, chemical synthesis, and fundamental processes of materials chemistry and physics to be probed under conditions identical to those relevant to energy technologies.<sup>64</sup> Over the next few years, NSLS-II will continue to build out its diverse suite of experimental end stations, opening up its world-leading brightness to a wider range of disciplines and scientific initiatives.<sup>65</sup>

### 9.4.2 Neutron Sources

Neutron scattering is an outstanding technique for the study of structural and dynamic properties of materials. It finds unique applicability across a spectrum of scientific fields including condensed matter physics, biology, chemistry, polymers, materials science, and engineering.<sup>67</sup> SC-BES currently operates two scientific user facilities for neutron scattering at ORNL: SNS<sup>68</sup> and the High Flux Isotope Reactor (HFIR).<sup>69</sup> The SNS is a pulsed source with nineteen operating beam-lines including eighteen allocated to neutron scattering instruments.<sup>70</sup> It is currently the highest power spallation neutron source in the world. The HFIR provides continuous (non-pulsed) neutron beams to a full suite of scattering instruments that have unique characteristics and are complementary to those at the SNS. The neutrons emitted from either type of source are passed through moderating materials that shift their energy and wavelength into a range useful as a probe of solid and liquid materials. The moderated neutrons are then channeled down flight paths to spectrometers where they interact with a material under study.

The moderated neutrons have wavelengths well matched to the spacing between atoms in materials and thus undergo diffraction from the crystal lattice in a material. This permits the determination of atomic structure in a manner analogous to X-ray diffraction, but with some significant differences. Neutrons are charge neutral and are thus not absorbed by most materials, making them highly penetrating and nondestructive. This provides the opportunity to obtain true three-dimensional structural information from large samples. This property is very important for a number of engineering applications, such as measuring strains in commercial components (see textbox: *New Approaches to Turbine Blade Manufacturing*).<sup>71</sup>

Neutrons possess a magnetic moment and are thereby additionally scattered by any array of magnetic moments within a material, enabling the determination of the magnetic structure simultaneously with the crystal structure. This capability has found unique application to the study of high energy-product permanent magnet materials, colossal magnetoresistive systems, and high-temperature superconductors. Another major unique attribute of neutron scattering as a probe of matter is its sensitivity to light elements. The scattering response of neutrons from both light and heavy elements is essentially equivalent, offering significant advantages for structural studies of soft matter and biological materials that contain mainly light elements such as hydrogen, carbon, nitrogen, and phosphorus. In addition, isotopes of the same element scatter neutrons with different intensity and phase, making possible isotopic substitutions that can enhance or diminish the scattering for specific elements. This unique contrast variation control has proven extremely valuable for the study of many biological systems.

Beyond determining atomic and magnetic structures via diffraction, neutrons can probe longer length scales using reflectometry and small angle neutron scattering (SANS) techniques. Reflectometry provides a depth probe for density or magnetic moment in, for example, polymers and thin films, respectively. SANS has wide

## New Approaches to Turbine Blade Manufacturing

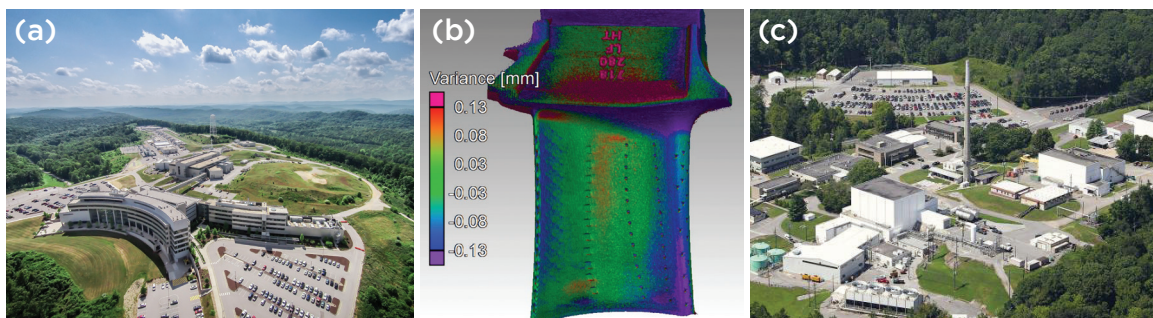
The SNS and HFIR, the SC-BES-supported neutron scattering scientific user facilities at ORNL, provide advanced analytical tools that support development of the next generation of manufacturing technologies (Figures 9.7a and 9.7c). The domestic aerospace industry is leveraging these tools to develop new manufacturing processes and improve on existing ones. These efforts are helping to ensure turbine blades for jet engines produced using these new techniques are of high quality—a characteristic directly related to the safety and fuel-efficiency of the airplane—and to maintain a position of leadership in this global industry.

Neutron computed three-dimensional (3D) tomography is a technique that combines multiple two-dimensional radiographic images to form a 3D image of an object's interior (Figure 9.7b). This technique is enabled by the high penetrating power of the neutron through bulk materials. At the SNS and HFIR, spatial resolutions as small as 75 microns are possible with this technique thanks to novel scintillator detectors developed at ORNL. These detectors convert the neutrons transmitted by the sample into light which is then used to construct the 3D image. Morris Technologies (purchased by General Electric Aviation in 2012) used this tomographic technique on its Inconel 718 turbine blades, which are fabricated using direct laser metal sintering, an additive manufacturing technique.

The neutron tomography results from the SNS and HFIR enabled researchers from Morris Technologies to improve their understanding of the link between residual stress distortions and laser-based additive manufacturing processing of turbine blades with optimized internal cooling structures. This study supports development of highly reliable and reduced cost turbine blades developed using a novel additive manufacturing process.

**Figure 9.7** Neutron tomographic imaging techniques available at the DOE-SC neutron scattering scientific user facilities SNS (a) and HFIR (c) were used by Morris Technologies to evaluate internal stresses in turbine blades produced by additive manufacturing (b).

Credit: Oak Ridge National Laboratory



application in studying porous structures and molecular or magnetic clusters in materials. Neutrons also undergo inelastic scattering, in which the energy of the neutron is shifted by interaction with the material.<sup>72</sup> Inelastic scattering has proven to be of great value in understanding many phenomena in magnetism, soft vibrational modes, atomic diffusion, and superconductivity.



Demand for instrument time at both facilities as well as at the National Institute of Standards and Technology Center for Neutron Research<sup>73</sup> far exceeds domestic capacity.<sup>74</sup> In the case of the DOE scientific user facilities, beam time is oversubscribed by a factor of two to five. Furthermore, new research directions in quantum condensed matter, structural biology and biomaterials, soft matter, and energy materials require new capabilities that currently are not available at existing domestic or international facilities. One promising avenue for enabling this new science and increasing available beam time is the proposed Second Target Station at the SNS.<sup>75</sup> This upgrade would provide approximately twenty new state-of-the-art instruments with a focus on techniques that require longer wavelength neutrons and that benefit from a lower neutron pulse rate. It would also increase the intensity of both target stations, thereby reducing the average collection time for an experiment.

### 9.4.3 Nanoscale Science Research Centers

Nanoscience is the study of materials and their behaviors at the nanometer scale—probing and assembling single atoms, clusters of atoms, and molecular structures. The ultimate goal is to design new nanoscale materials and structures and observe and understand how they function, including how they interact with their environment. Developments at the nanoscale and mesoscale have the potential to make major contributions to delivering scientific discoveries that transform our understanding of energy and matter and advance national, economic, and energy security.<sup>76</sup>

The Nanoscale Science Research Centers (NSRCs) are DOE-SC-sponsored scientific user facilities available for use by the national and international science community to advance scientific and technical knowledge in nanoscale science.<sup>77</sup> The NSRCs are designed to address SC-BES scientific grand challenges (see Section 9.2) in energy and are uniquely structured to address new grand challenges as energy science evolves. The five NSRCs are the Center for Functional Nanomaterials (CFN) at BNL, Center for Integrated Nanotechnologies (CINT) at SNL and Los Alamos National Laboratory (LANL), Center for Nanoscale Materials (CNM) at ANL, Center for Nanophase Materials Sciences (CNMS) at ORNL and The Molecular Foundry (TMF) at LBNL. The NSRCs are housed in purpose-built multi-laboratory buildings and strategically co-located with other DOE scientific user facilities such as X-ray light sources or neutron sources at DOE national laboratories across the United States (see Table 9.1).<sup>78</sup> The in-house and co-located facilities allow the NSRCs to integrate theory, synthesis, fabrication, and characterization in their research activities.

The mission of the NSRCs is to enable the external scientific community to carry out high-impact nanoscience projects and to conduct in-house research to discover, understand, and exploit functional nanomaterials for the benefit of society. To fulfill this mission, the NSRCs house the most advanced facilities for nanoscience research and employ world-class scientists who are experts in nanoscience to help develop these tools and support user research.<sup>79</sup> Each NSRC has distinct, but complementary, scientific themes for its internal staff science program and support a wide range of user activities across the full spectrum of nanoscale science, engineering, and technology with their instrumentation, capabilities, and staff technical expertise. The NSRCs perform primarily basic science and use-inspired basic science. However, applied research and commercialization activities with private sector users are an important part of the NSRC portfolio (see textbox: “Smarter” *Smart Windows Enabled by Nanoscience*).<sup>80</sup>

Although NSRCs perform primarily basic research, they support innovation and applied research with a range of users, including startup companies, large companies, universities, and DOE national laboratories. For example, CFN’s polymer nanostructure self-assembly capabilities have helped HGST realize terabit/cm<sup>2</sup> scale magnetic memories for computing and imaging. Chemical synthesis expertise at TMF helped Sematech develop an extreme ultraviolet chemically amplified resist that could be a candidate for microprocessor nodes at less than the current fourteen nanometer scale. CINT’s capabilities in nanoparticle synthesis and fluidics led to the launch of Vista Therapeutics’ commercial NanoBioSensor™. CNMS expertise in electron microscopy has helped 3M understand performance and durability limitations in fuel cells made with new nanostructured thin film catalysts.

Realizing new materials, creating nanostructures from them, and assembling them into complex structures all require pushing the limits of present synthesis, fabrication, and characterization tools. Understanding the resulting structures requires developing new theories and computational tools that are able to simulate and predict their functionality over a wide range of size and timescales. A major direction of the NSRCs over the next five years is the development of capabilities to create complex nanostructures and observe them under real operating conditions. The NSRCs are planning to develop advanced capabilities in the areas of *in situ*

## “Smarter” Smart Windows Enabled by Nanoscience

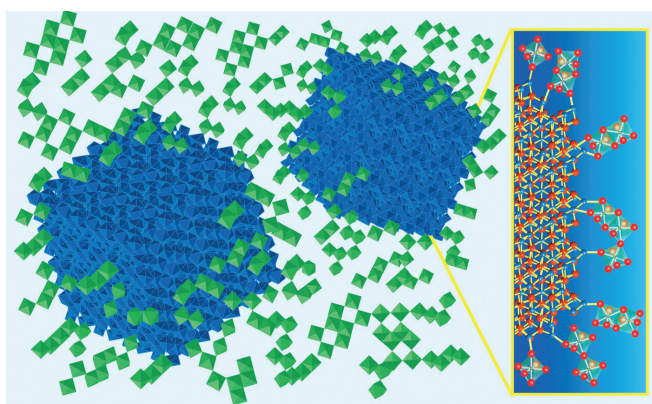
Nanoscience has led to many discoveries of material properties and new phenomena that have been developed into technologies, including energy technologies, which have generated significant commercial impact worldwide over the past thirty years.<sup>81</sup> At the root of the opportunities provided by nanoscience is the fact that all of the elementary steps of energy conversion (e.g., charge transfer, molecular rearrangement, and chemical reactions) take place on the nanoscale. Thus, the development of new nanoscale materials, as well as the methods to characterize, manipulate, and assemble them, create an entirely new paradigm for developing new and revolutionary energy technologies.

By capitalizing on advances in nanoscale synthesis, researchers from TMF at LBNL have developed a “smart” glass that can switch between blocking visible light, heat-producing near-infrared light, or both, depending on the magnitude of the applied potential. At the heart of the technology is a new “designer” electrochromic material, made from nanocrystals of indium tin oxide embedded in a glassy matrix of niobium oxide (Figure 9.8). Electrochromism is a reversible process that allows the glass to change its transmittance in response to electrochemical charging and discharging. The researchers found a synergistic interaction at the interface between the glassy matrix and nanocrystal, leading to enhancement of the electrochromic effect. As a result, thinner coatings can be used without compromising performance.

This work addresses a critical need for rapid and inexpensive fabrication of stable nanoscale materials that can have tunable electrical and optical characteristics and that can be scaled-up for large area applications. Heliotrope Technologies, an early-stage company, is developing these new materials and manufacturing processes for electrochromic devices with an emphasis on energy-saving smart windows.

**Figure 9.8** Nanocrystals of indium tin oxide (blue) embedded in a glassy matrix of niobium oxide (green) form a composite material that can switch between visible or near-infrared light transmitting and blocking states by application of an electric potential. A synergistic interaction in the region where glassy matrix meets nanocrystal increases the potency of the electrochromic effect.<sup>82</sup>

Credit: Reprinted by permission from Macmillan Publishers Ltd: *Nature* (500), 2013.





and *in operando* electron microscopy, scanning probe techniques, nanoscience with accelerator-based X-ray and neutron characterization, combinatorial nanomaterials synthesis, and advanced nanofabrication and nanostructure self-assembly (see textbox: *Growing Nano “Hair” for Electrodes*). These new capabilities, coupled with strong user-NSRC staff scientific collaborations, will have a transformative impact on physics, chemistry, materials science, engineering, technology, and many other fields.

## 9.5 Systems-Based Biological and Environmental Research for Energy

The development of a predictive understanding of energy-relevant biological systems promises new bio-based and bio-inspired technologies for both energy conversion and environmental applications. This understanding is being built on an increasing ability to rapidly decode the genomes of plants and microbes and on a more comprehensive understanding of the complex relationships that mediate the translation of genomics into subcellular and mesoscale macromolecular complexes that shape regulatory and metabolic pathways. The development of new systems approaches and synthetic biology tools are enabling the creation and control of properties and functionalities of biological systems for practical mission outcomes. Because the understanding of biological systems tends to require comparative insights derived from the study of multiple organisms, a key element of this approach is the development and nurturing of a new culture of collaboration among researchers for the sharing of data and resources, with the goal of achieving a community knowledge base to drive further discovery.<sup>84</sup>

New genome-enabled (i.e., “-omics”) experimental capabilities and enabling technologies are being developed to achieve improved multimodal measurements of dynamic fluctuations in gene expression, enzyme activity, and metabolite processing at high spatial and temporal resolution. These capabilities leverage the resources of the DOE-SC scientific user facilities, including the X-ray light sources and high-performance computers. These state-of-the-art capabilities enable the scientific community to probe the biological mechanisms that underpin discovery and innovation for future renewable bioproducts and biofuels.

SC-BER seeks to understand the continuum of biological, biogeochemical, and physical processes from the smallest scales (genomes and metabolic pathways) to the largest scales (ecosystems and atmospheric observation). SC-BER strives to describe and explain how genomic information is translated to functional capabilities, enabling more confident redesign of microbes and plants for sustainable biofuels production, improved carbon storage, and understanding of the biological transformation of materials such as nutrients and contaminants in the environment. SC-BER research also advances understanding of how the earth’s dynamic, physical, and biogeochemical systems (the atmosphere, land, oceans, sea ice, and subsurface) interact and cause future climate and environmental change, to provide information that will inform plans for future energy and resource needs. All of these efforts are enabled by the three SC-BER supported user facilities described below: the Joint Genome Institute (JGI), the Environmental Molecular Science Laboratory (EMSL), and the Atmospheric Radiation Measurement (ARM) Climate Research Facility. This suite of tools—genomic, analytical, and observational—permit measurements at each scale in the enormous spatial and temporal continuum encompassed by this program, and provide a basis for computationally understanding how the smallest pieces impact the largest systems.

The following three sections describe the facilities that enable the science discoveries described above. This description of the facilities starts at the atomic and molecular scale (e.g., genome sequencing or elemental analysis of aerosol particles) and ends at the global scale (atmospheric observations as input to global climate models). The discoveries described above and in the examples below typically are fundamental in nature, but have an impact—direct or indirect—on the technologies described in this report. At the molecular scale, the tools of the JGI allow researchers to rationally design plants that have significantly higher sugar yields



## Growing Nano “Hair” for Electrodes

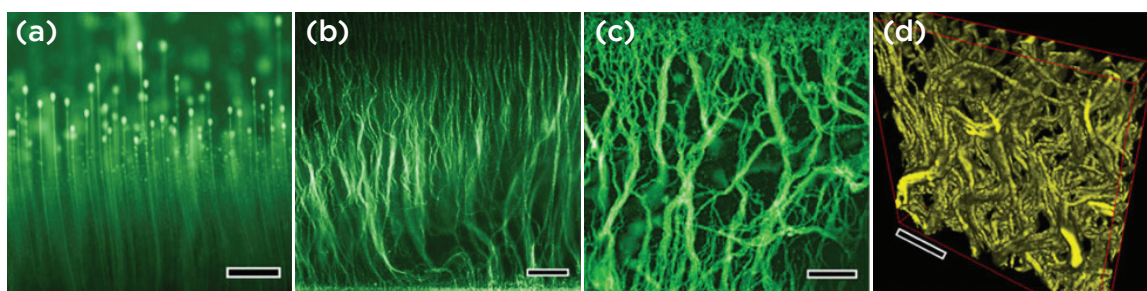
Humankind’s ability to create and manipulate the properties of materials has taken much inspiration from the natural world. Biology uses dynamic, out-of-equilibrium processes to assemble cellular components in response to specific signals. Mimicking this assembly approach to organize simple building blocks into complex architectures presents a unique opportunity to learn from nature and go beyond. However, in practice, using this “bottom-up” approach to mesoscale design to form complex structures over multiple length scales has proven to be difficult, since the assembled structures fall apart once the applied stimulus used to direct their formation has been removed.

Inspired by nature, a new self-assembly process has been discovered for fabricating stable 3D structures in response to an applied stimulus. Scientists at ANL using instruments at the CNM developed self-assembled tunable networks of polymer fibers similar to the “hairy” surfaces that exist in our bodies to protect blood capillaries from wear and infection. Using tiny, sticky epoxy droplets as the building blocks, 3D structures ranging from arrays of tiny mushroom pillars (Figure 9.9a) to wavy colloidal “fur” (Figure 9.9b) to highly interconnected networks (Figure 9.9c) were formed on an electrode surface in an electric field. The features of the resulting architectures were tuned by controlling the electric field and droplet surface properties. The structure could then be coated with an atomically thin layer of a conductive material.

This work addresses a critical need for rapid and inexpensive fabrication of stable nano- and mesoscale fibrous materials that can be assembled dynamically and reversibly in response to an applied electric field. Using this approach, tunable 3D architectures can be formed directly on electrode surfaces and further functionalized with conductive materials, which makes this a promising candidate approach for forming low-cost, large surface area electrodes in batteries and organic photovoltaic cells.

**Figure 9.9** Control of the synthesis results in a diversity of self-assembled structures formed by sticky epoxy droplets: (a) array of “mushrooms,” (b) wavy colloidal “fur,” (c) dense fiber network, and (d) a 3D reconstruction of the dense fiber network.<sup>83</sup>

Credit: Reprinted by permission from Macmillan Publishers Ltd: *Nature Communications* (5), 2014 .





needed for biofuel production. At the global scale, the *in situ* observation tools of ARM are yielding better climate models that will produce more accurate forecasts of future energy needs, potentially impacting policy and investment decisions for the technologies described in this report. Each section concludes with a short description of the near-term developmental goals for each facility, and their impact on both science and technology discoveries.

### 9.5.1 Joint Genome Institute

The mission of the JGI is to advance genomics in support of the DOE missions related to clean energy generation as well as environmental process understanding. JGI provides foundational genomic, bioinformatics, and deoxyribonucleic acid (DNA) synthesis research to underpin cost-efficient production of advanced biofuels and bioproducts from renewable biomass. Operated by LBNL, the JGI is a scientific user facility primarily focused on genome sequencing and interpretation through the Community Science Program, which engages the research community to characterize organisms relevant to DOE science mission areas in bioenergy, global carbon cycling, and biogeochemistry.<sup>85</sup> JGI provides integrated high-throughput DNA and ribonucleic acid (RNA) sequencing and computational analyses that enable systems-based scientific approaches to these challenges.

At its most fundamental purpose, genome sequencing provides the “source code” for biological structures and activities. Even more simply, sequencing generates the “parts list” for an organism or cell. JGI sequencing efforts are providing a large, publicly available database of genetic information that scientists are exploring in search of new capabilities in support of bioenergy research.<sup>86</sup> JGI data contribute to all aspects of the SC-BER Biological Systems Science Program mission space as well as more far reaching explorations of realms of microbiology that will inform future efforts. These include uncovering genomes from previously unexplored regions of microbial taxonomy and elucidating altered “interpretations” (recoding) of DNA sequences in newly sequenced organisms.

A significant part of the JGI mission is to work with the BRCs.<sup>87</sup> Biofuels currently contribute a very small portion of the domestic energy supply.<sup>88</sup> However, the quantity of biomass potentially available for conversion to biofuels exceeds one billion tons annually, which would translate to approximately 30% of current transportation fuel needs.<sup>89</sup> Revolutionary methods for breaking down biomass of a wide diversity of compositions and converting it to fuel compounds or precursors to fuel compounds is a high priority for DOE. The three BRCs (see Section 9.2.3) conduct research on breaking down plant biomass to its cellulose, hemicellulose, and lignin components, and then further reducing these compounds to the component sugar units that are fermented into alcohol-based fuels. JGI’s sequencing efforts identify genes whose products may be useful for carrying out these reactions, characterizing variants of genes that may underpin differential properties relevant to biofuel processes, and synthesizing DNA segments useful both as analytic tools and as vectors for new capabilities to enable the BRCs to better carry out their scientific aims.

JGI emphasizes frequent strategic planning in order to keep pace with the extremely dynamic scientific and technological developments in genomics research. The current ten-year vision for the JGI describes its evolution into a next-generation genome science user facility.<sup>90</sup> A primary aim of the JGI is to establish capabilities for functional “annotation” (the assignment of experimentally validated functions) to gene products. Toward that end, massive-scale DNA and RNA sequencing is being supplemented with access to high-throughput experimental and computational capabilities to identify which genes have desired functional properties. Furthermore, large-scale DNA synthesis will be required for both annotation and synthesis of the molecular machinery that will generate tools for deeper analyses as well as, ultimately, the desired products.

While the quest for sustainable biofuels is a prime mission, it represents only one of several high-level energy and environmental challenges that will be supported by the sequencing capabilities of the JGI. Other examples include improving the growth characteristics of plants through the manipulation of plants, microbes, and

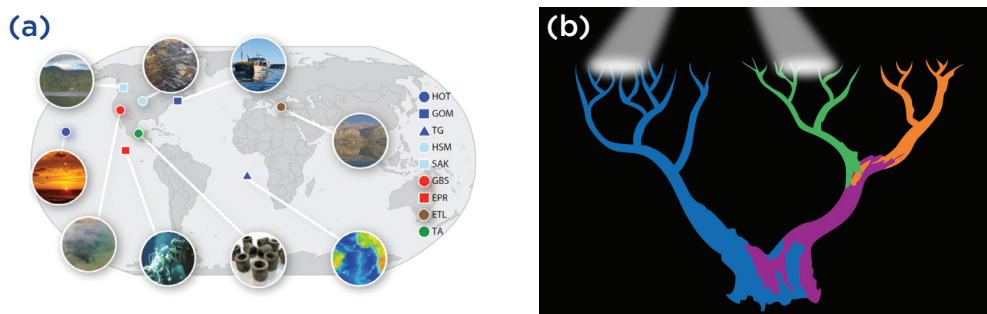
their interactions, engineering organisms for improved light capture and energy conversion, discovering and studying new branches of life and new metabolic activities through massive-scale sequencing of unexplored microbial “dark matter” (see textbox: *Illuminating Biology’s “Dark Matter”: Discoveries from the Deep Space of the Microbial Realm*), and providing the data required to model and predict release of greenhouse gases from warming permafrost.

## Illuminating Biology’s “Dark Matter”: Discoveries from the Deep Space of the Microbial Realm

In cosmology, dark matter is said to account for the majority of mass in the universe; however, its presence is inferred by indirect effects rather than detected through telescopes. The biological equivalent is microbial “dark matter,” the unseen majority of microbial life on Earth that can profoundly influence key environmental processes such as plant growth, nutrient cycles, the global carbon cycle, and climate processes. This unexplored realm consists of microbial organisms that cannot yet be directly identified or cultivated in the laboratory and are thus difficult to study and ascribe specific functions through direct observation and manipulation. An international collaboration, led by the JGI, has targeted these uncultivated microbial cells from nine diverse habitats, derived from twenty-eight major previously uncharted branches of the tree of life. Using advanced -omics techniques and computational algorithms, the results fall into three main areas: 1) discovery that metabolic features previously only seen in bacteria are also in Archaea, such as an enzyme used by bacteria to “thin out” their protective cell wall so that the cell can expand during cell division; 2) the ability to correctly assign data from 340 million DNA fragments from other habitats to the proper lineage, linking these fragments to organisms and particular ecosystems, as well as providing insights into possible functional roles; and 3) the ability to more accurately resolve microbial taxonomical relationships within and between microbial phyla, which is critical to predict ecological niches and capabilities. The new results will enable scientists to better predict metabolic properties and other useful traits of different groups of microbes. This work builds upon a JGI pilot project, the Genomic Encyclopedia of Bacteria and Archaea.<sup>91</sup>

**Figure 9.10** (a) Samples for metagenomic analyses collected from numerous sites across the globe and sequenced at the JGI have detected numerous previously unknown microbial species. (b) The results shine a metagenomic spotlight on previously unknown areas of the phylogenetic tree, thereby broadening our view of the diversity of the microbial world.<sup>92</sup>

Credit: Joint Genome Institute





### 9.5.2 Environmental Molecular Science Laboratory

The EMSL, a DOE-SC scientific user facility located at Pacific Northwest National Laboratory (PNNL) in Richland, Washington, leads molecular science discoveries that support the SC-BER and DOE missions that translate to predictive understanding and accelerated solutions for national energy and environmental challenges. EMSL provides premier experimental capabilities, production computing hardware, and software optimized for molecular research to address the fundamental physical, chemical and biological processes that underpin larger-scale climate, energy, and environmental challenges, including novel energy fuels and batteries, and components to enhance energy efficiency in vehicles.<sup>93</sup>

The EMSL solicits research campaigns in its four science themes of atmospheric aerosols, biological dynamics, subsurface and terrestrial ecosystems, and energy materials that combine experimental and computational efforts as well as multiple methods and approaches (see textbox: *Efficiency of Aerosol Particles to Serve as Cloud Condensation Nuclei and Cloud Formation*). Major capabilities provided by the EMSL include magnetic resonance spectroscopy, mass spectrometry, *in situ* imaging, and molecular science computing.<sup>94</sup> These tools are necessary to obtain, for example, a systems-level understanding of how proteomic and metabolomic information are translated into the functional capabilities of living systems, or how the physical and chemical properties at critical interfaces can be tailored for more efficient energy storage and conversion systems. The suite of techniques available at the EMSL are enabling for science across the SC-BER portfolio, including prediction and redesign of metabolic processes,<sup>95</sup> subsurface flow and transport,<sup>96</sup> and modeling and characterization of new energy materials.<sup>97</sup>

The capabilities at EMSL continue to evolve to support characterization of the chemistry and dynamics of molecular species in complex natural systems. The unique 21 tesla high-resolution mass spectrometer<sup>98</sup> will enable EMSL scientists and users to study metabolic processes within and among cells, the composition of organic matter in cells, natural organic matter, secondary organic aerosols, and the formation of aerosol particles. An aberration-corrected dynamic transmission electron microscope will enable users to image dynamic processes within cells/living systems at close to atomic spatial resolution and micro to nanosecond temporal resolution.

### 9.5.3 Atmospheric Radiation Measurement Climate Research Facility

The largest uncertainty in future climate predictions is how changes in aerosol and cloud properties will interact with the earth's energy balance to either amplify or reduce warming. In order to develop improved predictions of these climate “feedbacks,” researchers need extensive observational data to develop more efficient and accurate treatments of aerosol, cloud, and radiative transfer processes in global weather and climate models. The ARM Climate Research Facility is a DOE-SC<sup>100</sup> scientific user facility that develops and manages strategically located *in situ* and remote sensing observatories designed to provide the data necessary to improve the understanding and representation of the radiative impact of clouds and aerosols in climate and Earth system models as well as their interactions and coupling with the earth's surface. This description will help to resolve the uncertainties in climate and Earth system models, supporting development of sustainable solutions for the nation's energy and environmental challenges, including improved confidence in weather and climate predictions that, in turn, enhance public warning capabilities associated with severe weather, and improving tools for energy infrastructure security.

The vision of ARM is to provide a detailed and accurate description of the earth's atmosphere in diverse climate regimes. To that end, ARM capabilities are located across the United States and at select international locations. Three fixed observational sites are located in Oklahoma, Alaska, and the Azores. Three mobile facilities, deployable across the globe,<sup>101</sup> as well as an aerial facility,<sup>102</sup> are designed to address science issues beyond the scope of the fixed observation facilities. All of these facilities are equipped with state-of-the-art remote sensing

## Efficiency of Aerosol Particles to Serve as Cloud Condensation Nuclei and Cloud Formation

The atmospheric radiative energy balance that, in turn, influences climate variability is strongly influenced by the liquid, ice, and aerosol properties that form cloud condensation nuclei (CCN), the precursors of cloud droplets and cloud formation. Despite numerous field observations of clouds and particles, many uncertainties remain, including the fraction of particles that can become CCN, whether CCN particles are associated with unique chemistry and/or preferred geomorphology, and whether a wider set of particles can lead to different types of CCN. Current cloud microphysics models have taken a simplified approach by identifying only a subset of “qualifying” particles for CCN formation. This results in models that may not represent the full range of atmospheric conditions important to weather and climate, and therefore, high levels of prediction uncertainty in the CCN-affected atmospheric component of the models.

To improve understanding and reduce model uncertainty, a team of researchers involving scientists from the State University of New York at Stony Brook, LBNL, and the College of the Pacific obtained field samples collected in California using ARM. These atmospheric cloud and aerosol samples contained particles with highly variable types of organic compounds coating their surfaces. The ARM data included critical information on the distributions of liquid and ice droplets in each sample as well as the rates of CCN formation within each sample. The physical and chemical properties of the field samples were further analyzed using sophisticated micro-spectroscopy and chemical imaging techniques at the EMSL.

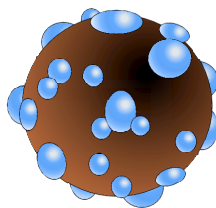
Statistical analysis of the particle properties within and between samples revealed that ice nucleating particles are not dissimilar to droplet nucleating particles. Furthermore, particles that inefficiently produce ice particles can be equally as important as those that efficiently produce cloud droplets, particularly if the less-efficient nucleating particles are abundant in the sample. This study disproved the paradigm that very few types of atmospheric aerosol particles can serve as the seed for ice crystals, showed that a wide variety of particles can lead to ice crystal formation, and revealed that CCN efficiency depends, in part, on organic compounds covering their surfaces. These results are transforming approaches to improve atmospheric and climate prediction models.

**Figure 9.11** (a) Under normal conditions, a cloud droplet (and cloud ice particle) requires a microscopic particle on which water vapor can condense. It was assumed that only a small fraction of airborne particles have the right chemistry and/or geometry to condense water vapor. (b) Using samples collected by the DOE ARM facility and chemical imaging and micro-spectroscopic techniques at the EMSL, it was discovered that nearly all classes of particles can serve as cloud condensation nuclei for droplet and ice but with variation in formation efficiency that depends on organic coatings. This new information will be used to improve model parameterizations and reduce uncertainties in climate predictions.<sup>99</sup>

Credit: (a) Center for Multiscale Modeling of Atmospheric Processes; (b) Pacific Northwest National Laboratory

(a)

condensation  
nuclei  
attracting  
water vapor



(b)





## Geoengineering

DOE supports no programs or research and development activities focused on deliberate alterations of the earth's climate, often referred to as "geoengineering." In 2015, the National Academy of Sciences released two reports: *Climate Intervention: Carbon Dioxide Removal and Reliable Sequestration*,<sup>108</sup> and *Climate Intervention: Reflecting Sunlight to Cool Earth*.<sup>109</sup> The first report noted that the costs for removing CO<sub>2</sub> from the atmosphere may be comparable to or exceed those of shifting to lower CO<sub>2</sub>-emitting energy sources. The report recommended further research into CO<sub>2</sub> removal strategies in order to, among other goals, identify risks and reduce costs. DOE is supporting RDD&D on CCS, which could be combined with bioenergy systems to provide a net reduction of atmospheric CO<sub>2</sub> (see Chapters 4, 7, and 10). The second report noted the risks of activities known collectively as "albedo modification" were poorly understood. The report recommended against any deployment at "scales sufficient to alter climate," but recommended a research program that focused on multiple-benefit research (e.g., understanding clouds and aerosols), and potentially field experiments at the "smallest practical scales."

instrumentation for measuring atmospheric state variables, trace gases, solar and infrared radiation, surface fluxes, and cloud and aerosol properties.<sup>103</sup> ARM also supports a mobile aerosol observing system that includes capabilities for *in situ* measurements of aerosol chemistry properties.

ARM observations are having a significant impact across the climate research community (see textbox: *Experimental Confirmation of the Greenhouse Effect Due to Carbon Dioxide Emissions*). For example, using ARM observations of the strength of water vapor absorption researchers have substantially improved calculations of far-infrared radiation in radiative transfer models, leading to improvements in a wide variety of atmospheric parameters.<sup>104</sup> Beyond observational efforts, researchers using ARM are developing novel computational models for radiative transfer that increases their efficiency and accuracy in global climate models. Further, the above improvements in radiative transfer modeling and in representations of aerosol and cloud processes in numerical models are having ancillary benefits for solar and wind energy forecasting and for weather forecasting.

Because the accuracy of climate prediction models relies on the quality of parameterizations derived from its data, ARM has steered its priority observations to enhancing our understanding of atmospheric phenomena in regions of high priority scientific interest. The impacts of the warming Arctic basin on cloud physics, changes in aerosol-cloud interactions in the tropics, and the behavior of cloud-aerosol-precipitation interactions during extreme events in all geographic regions are of high priority interest. ARM is adding a very high resolution modeling and simulation component to facilitate and more efficiently link observations to climate model development and predictions.

Climate prediction outputs also serve as input data to integrated assessment and impact, adaptation, and vulnerability models (IAM and IAVM, respectively) that in turn, are built and exercised by the DOE research community. IAMs and IAVMs provide robust evaluations of interdependencies of the energy, water, carbon, and infrastructure sectors, and they can evaluate the sensitivity of model outputs to improved representations of the atmosphere, terrestrial ecologies, and land usage (see also Section 10.4). In particular, the IAMs have the capacity to determine the climate mitigation capacity of emerging low-carbon technologies, such as wind and solar. ARM observations, together with other data from the weather, energy, hydrological sectors, infrastructure, and socioeconomic sectors, will allow next generation models that combine IAMs and IAVMs to evaluate uncertainty and risk associated with a variety of technology development and deployment pathways of relevance to the DOE mission.

## Experimental Confirmation of the Greenhouse Effect Due to Carbon Dioxide Emissions

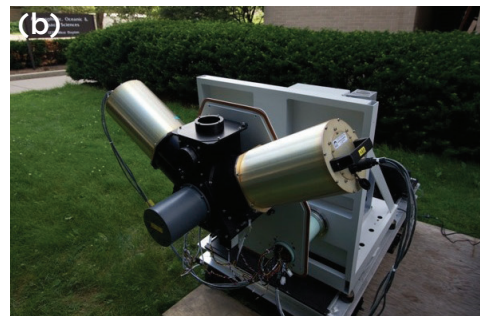
Scientists from LBNL used field observations to confirm directly, for the first time, that increasing levels of CO<sub>2</sub> will warm the atmosphere via the greenhouse effect. The study results are based on observations and other data products collected at the Alaska and Oklahoma ARM sites. Using an eleven-year record of infrared spectral signatures collected at both sites, researchers confirmed previously reported theoretical predictions and laboratory results that indicated increasing atmospheric CO<sub>2</sub> concentrations will lead to increased heating of the atmosphere due to greater absorption of infrared radiation.

Results of the study relied heavily on very precise measurements of the temporal variability of spectral signatures of CO<sub>2</sub>, local meteorology, direct measurements of atmospheric CO<sub>2</sub> concentration profiles, removal of the fair-weather bias, and a detailed atmospheric radiative transfer model that included line-by-line spectral radiative transfer and including spectral CO<sub>2</sub> lines. Researchers heavily relied on two instruments designed specifically for ARM facilities. The two atmospheric emitted radiance interferometers (AERIs) were designed to meet the stringent accuracy requirements necessary to carry out this study.

The statistical analysis used to reach the study conclusions used 3,300 daily observations from Alaska and 8,300 daily observations from Oklahoma. Based on data from the AERIs and supporting observations collected at both the Alaska and Oklahoma ARM sites, this study confirmed, for each site, that the theoretical predictions of greenhouse warming were robust and conclusive.

**Figure 9.12** Analysis of an eleven-year record of spectral radiance data from ARM sites in Oklahoma and Alaska confirmed theoretical predictions that higher concentrations of atmospheric CO<sub>2</sub> result in increased absorption of infrared energy, and hence atmospheric warming. Until now, the measurement accuracy combined with the length of the data record was inadequate to “prove” beyond doubt that increasing CO<sub>2</sub> must relate to global warming via infrared heating, thus making this analysis groundbreaking. (a) The ARM Oklahoma site. (b) One of the two AERIs that were used to collect the eleven-year data record at both sites.<sup>107</sup>

Credit: ARM Climate Research Facility





ARM observational data are freely available to registered users through the ARM data archive.<sup>105</sup> The value of this data and of the facilities to the climate research community is evidenced by the increase in data downloads from 6.4 terabytes (TB) to 23.7 TB in three years and the corresponding incidence of ARM data citations in the Intergovernmental Panel on Climate Change *Fifth Assessment Report*.<sup>106</sup>

In the next five to ten years, new capabilities for routine large-eddy simulation modeling will be developed to better link ARM observations to the ultimate goal of improving global models. To support this goal, the measurement density around the ARM Oklahoma and Alaska sites will be increased, higher-order data products that are more suitable for model evaluation will be developed, and instrument simulators for more direct evaluation of models with observational data will be developed.

## 9.6 Modeling, Simulation, and Data Analytics of Complex Phenomena

The scientific developments described in the preceding sections are increasingly being driven by advances in the field of computation, where DOE and DOE-SC are developing and using advanced modeling and simulation techniques to replicate complex real-world phenomena and developing the data analytics capabilities needed to interpret large computational and experimental data sets. The computational capabilities needed to provide these capabilities range from the desktop to the high-performance computer.

Advanced simulation offers the opportunity to move from trial-and-error experimental processes to computational design of materials. New computational capabilities, combined with important theoretical advances, hold the promise for the first time of systematic, theory-based design of new materials *ab initio*, i.e., from first principles. Already, simulations employing a key approach known as Density Functional Theory are being used to identify promising new compounds for a range of applications.<sup>110</sup> The move to design-by-simulation will significantly accelerate the discovery and development of new materials for energy applications.

Computational approaches are not only accelerating the process of genomic sequencing of organisms but also facilitating collaboration and building the comparative knowledgebase that will hold the key to improving our understanding and control over biological systems for energy and environmental applications. In systems biology, with so much diversity, sensitivity to tiny perturbations, and interconnections across a wide range of timescales, advanced computing may well be the only way to fully characterize the dynamics that determine outputs such as biofuel production.

Understanding the earth's climate requires understanding the dynamic, physical, and biogeochemical systems (i.e., the atmosphere, land, oceans, sea ice, and subsurface), and how they interact and cause future climate and environmental change. The inherent complexity of these systems and our limited ability to observe processes and interactions as they occur have proven to be major challenges to predictive climate simulations at the global scale and over extended time frames. Innovative code and algorithm designs are being developed for optimal model computation on current and future high-performance computers. Climate modeling, simulation, and analysis tools will be essential in informing investment decision-making processes for infrastructure associated with future large-scale deployment of energy supply and transmission.

Today's DOE Leadership Computing Facilities have modeled neutron transport in nuclear reactor cores to predict the behavior of nuclear fuels,<sup>111</sup> conducted combustion simulations to increase fuel efficiency,<sup>112</sup> shaped the front ends of long-haul trucks to make them more energy efficient,<sup>113</sup> and simulated ice formation in water droplets to reduce the wind turbine downtime in cold climates.<sup>114</sup> Simulation provides insight into technologies that could not be obtained through testing due to challenges in instrumentation, and saves time and money by reducing expensive and time-consuming testing. The increased physical insight, when coupled with time and money saved, provides U.S. companies with a competitive advantage in moving technologies



from the laboratory to production. The next generations of computers will allow even greater understanding and prediction in science and engineering, further accelerating scientific discovery and the creation of complex, engineered systems.

This push to modeling and simulation of real systems is enabled by the parallel development of hardware (computers and networking infrastructure), algorithms, software (operating systems and codes), and personnel. The mission of the Office of Advanced Scientific Computing Research (SC-ASCR) is to discover, develop, and deploy computational and networking capabilities to analyze, model, simulate, and predict complex phenomena important to DOE. The development of these capabilities has been, and continues to be, guided by science needs developed collaboratively with the research community.<sup>110</sup> SC-ASCR's research focuses on the parts of DOE's research agenda that require the most advanced computational capability or novel algorithms.

SC-ASCR has developed multiple approaches to ensure that high-performance computing resources are available, and used, in applied energy areas to advance both basic science and system design. These approaches include ensuring that allocations are available on supercomputers to support research that requires these capabilities,<sup>116</sup> and development of computational tools for DOE science and engineering needs.<sup>117</sup> SC-ASCR has been particularly successful in working with other Office of Science programs through the Scientific Discovery through Advanced Computing (SciDAC) Program. SC-ASCR also works with other programs using approaches such as Hub-based development of new simulation tools,<sup>118</sup> direct integration of simulation with large-scale experimental facilities, and regular communication between DOE-SC and other DOE programs through the Advanced Computing Tech Team (ACTT).<sup>119</sup>

The following sections provide an overview of existing DOE capabilities in computer hardware, networking, and the nonphysical infrastructure required to utilize these resources. Recent examples from research across the DOE computational landscape are provided to demonstrate some of the ways scientific computing is impacting both basic and applied research. Current DOE efforts for increasing computing capabilities by reaching exascale performance levels<sup>120</sup> are discussed, including the potential impact of exascale computing in applied technologies.

### 9.6.1 Supercomputing Capabilities at the DOE Laboratories

DOE-SC and the entire DOE complex have historically driven development in cutting-edge computing capabilities. Currently, DOE laboratories support four of the top fifteen supercomputers in the world.<sup>121</sup> DOE-SC operates three HPC user facilities: the Argonne Leadership Computing Facility (ALCF), the Oak Ridge Leadership Computing Facility (OLCF), and the National Energy Research Scientific Computing Center (NERSC) at LBNL. ANL and ORNL operate Mira and Titan, respectively, two of the world's fastest supercomputers. These machines are reserved for a small number of projects addressing science and engineering problems that would be prohibitively expensive or impossible to solve on less-powerful machines through allocation processes open to the larger scientific community. The speed of these computers is measured in petaflops (10<sup>15</sup> floating point operations per second, or pflops).<sup>122</sup> Mira is rated at 8.59 pflops, while Titan is rated at 17.59 pflops with a theoretical peak of more than 27 pflops. This computational power allows these computers to rapidly solve problems that include complex physics over a range of length and timescales. Current science applications include climate simulation, fusion, and atomistic-level simulation of materials.<sup>123</sup>

NERSC operates two pflop machines: Edison (2.6 pflops) and Hopper (1.3 pflops), and is expected to take delivery of Cori (28 pflops) in 2016. NERSC machines are "production" machines; they are used by an extremely wide group of users (5,950 active users from forty-eight states and forty-six countries in FY 2014) for problems that do not require the computing power of the leadership-class machines. NERSC users are drawn from both Office of Science researchers and researchers whose work is aligned with the DOE-SC mission (see textbox: *Nanostructures Half a DNA Strand-Wide Show Promise for Efficient LEDs*).



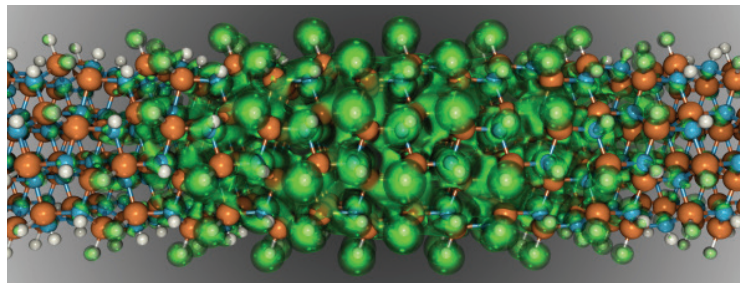
## Nanostructures Half a DNA Strand-Wide Show Promise for Efficient LEDs

Light-emitting diodes (LEDs) are semiconductor devices that emit light when an electrical current is applied. At low power, nitride-based LEDs (most commonly used in white lighting) are very efficient, converting most of their energy into light. But efficiency plummets when the power is turned up to levels that could light up a room, meaning a smaller fraction of electricity is being converted to light. This effect is especially pronounced in green LEDs, giving rise to the term “green gap.”

Nanomaterials offer the prospect of LEDs that can be “grown” in arrays of nanowires, dots or crystals. The resulting LEDs would not only be thin, flexible, and high-resolution, but very efficient, as well. University of Michigan researchers used supercomputing resources at NERSC to demonstrate that nanostructures half the breadth of a DNA strand could improve the efficiency of LEDs, especially in the green gap region. They found that the semiconductor indium nitride, which typically emits infrared light, will emit green light if reduced in size to a one nanometer-wide wire (Figure 9.13). Moreover, by varying their sizes, these nanostructures could be tailored to emit different colors of light, which could lead to more natural-looking white lighting while avoiding some of the efficiency loss today’s LEDs experience at high power.

**Figure 9.13** The semiconductor indium nitride, which typically emits infrared light, will emit green light if reduced to a one nanometer-wide wire.<sup>124</sup>

Credit: Lawrence Berkeley National Laboratory



Computing time is allocated by SC-ASCR through a competitive, merit-based proposal review to researchers in the private sector, universities, DOE national laboratories, and other federal agencies.<sup>125</sup> The majority of available time on the leadership-class computers is allocated through two programs: the SC-ASCR Leadership Computing Challenge (ALCC) Program, and the Innovative and Novel Computational Impact on Theory and Experiment (INCITE) Program. The ALCC Program provides single-year allocations to research that either contributes directly to DOE’s mission, responds to national emergencies, or expands the community of researchers using the leadership class-computing to include new scientific areas. Table 9.3 shows awards made through the 2015 ALCC Program to researchers in energy-related projects.<sup>126</sup>

INCITE awards are multi-year awards targeting computationally intensive, high-impact simulations that require DOE leadership-class computers. The projects represent the most challenging problems, regardless of scientific discipline, and do not necessarily support specific DOE missions. Projects receiving FY 2015 awards included simulations of blood flow during aneurysms, radiotherapy of cancer with ion beams, and

**Table 9.3** 2015 ALCC Awards Relevant to Energy Technology

Technology area and project title		Institution
Bioenergy	Predictive Modeling of Functional Nanoporous Materials	University of Minnesota
	Developing Hyper-Catalytic Enzymes for Renewable Energy	ORNL
	Molecular Dynamics Studies of Biomass Degradation in Biofuel Production	University of Illinois
Fossil energy	Credible Predictive Simulation Capabilities for Advanced Clean Energy Technology Development through Uncertainty Quantification	ALPEMI Consulting, LLC
	Chombo-Crunch: Modeling Pore Scale Reactive Transport Processes Associated with Carbon Sequestration	LBNL
	Multi-Scale Modeling of Rotating Stall & Geometric Optimization	Dresser-Rand
	Large-Eddy Simulation of Turbine Internal Cooling Passages	General Electric
	System-Level Large-Eddy Simulation of High-Efficiency Gas Turbine Combustors to Advance Low-Emissions Combustion Technology	General Electric
Nuclear energy	Delivering Advanced Modeling & Simulation for Nuclear Energy Applications	ORNL
	Toward a Longer-Life Core: Thermal-Hydraulic CFD Simulations of Deformed Fuel Assemblies	ANL
	Large Eddy Simulation and Direct Numerical Simulation of Fluid Induced Loads on Reactor Vessel Internals	Westinghouse
	High-Fidelity Computations of Fuel Assemblies Subjected to Seismic Loads	George Washington University
Renewable electricity	Computational Design of Interfaces for Photovoltaics	Tulane University
	First Principles Large Scale Simulations of Interfaces for Energy Conversion and Storage	University of Chicago
	Prediction of Morphology and Charge-Transfer Properties in Bulk Material and at Donor/Acceptor Interfaces of Thin-Film Organic Photovoltaic Cells	University of California Los Angeles
	Simulating Multiphase Heat Transfer in a Novel Receiver for Concentrating Solar Power (CSP) Plants	University of Colorado
	Validation of RAP/HRRR for the Wind Forecast Improvement Project II	National Oceanic and Atmospheric Administration
Vehicles	Advancing Internal Combustion Engine Simulations using Sensitivity Analysis	ANL

mapping of southern California's vulnerability to earthquakes. Because many problems in energy are among the most computationally challenging, recent awards have included materials modeling for battery systems, carbon sequestration, simulations of combustion processes, edge plasma transport in tokamak fusion reactors, statewide electric grid optimization (see textbox: *Improving the Energy Grid*), and computational spectroscopy of heterogeneous interfaces for solar energy conversion devices.<sup>127</sup>



## Improving the Energy Grid

The electrical grid has been described as “the largest and most complex machine ever made.”<sup>128</sup> Accurately simulating this system requires combining the behavior of millions of consumers, the operation of thousands of power plants, weather events, and the decision-making processes of the utilities themselves. Simulating a system with this level of complexity requires high-performance computing. Accurate grid simulation has become even more complex due to changes in the grid, such as the increasing use of weather-dependent solar and wind resources, and sophisticated and highly localized, high-speed decision making at the consumer level. The complexity and range of conditions required for these simulations require stochastic optimization, where the response of the grid to a large sample of random inputs is computed.

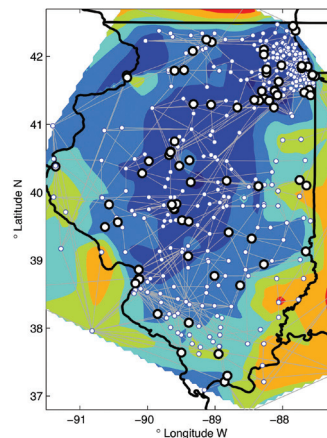
High-performance computing can be used to address a key challenge in planning for the future of the electric grid: increasing penetration of wind and solar energy resources. All power plants, conventional or renewable, are subject to outages or changes in power, requiring reserves and other power sources that can be ramped up or down quickly.<sup>129</sup> These changes in output are both more frequent, and less predictable, for weather-dependent renewables such as solar and wind energy. Because reserves are expensive to maintain and operate, finding the minimum required reserves for the expected penetration of these technologies is crucial to affordable deployment.

In 2012, an INCITE-supported team led by ANL used ALCF supercomputing capabilities to demonstrate that up to 20% wind penetration could be accommodated on some configurations without the need for a significant increase in reserves (Figure 9.14).<sup>130</sup> This result showed that new reserves would not be needed to prepare for increased penetration of wind resources, removing another impediment to greater adoption.

These results could only be obtained using the newer stochastic methods, and demonstrate the benefits of improved computational tools for grid simulation. SC-ASCR has continued work in this area through the Multifaceted Mathematics for Complex Energy Systems (M2ACS) project, which includes researchers from ANL, PNNL, SNL, the University of Wisconsin, and the University of Chicago.<sup>131</sup> New grid simulation capabilities can be used to plan for the future of the grid, develop new operational approaches, and predict the impact of grid disruptions due to physical and cyber attacks and natural disasters.<sup>132</sup>

**Figure 9.14** The features and implied energy prices of the stochastic programming formulation are shown for the state of Illinois. The model contains approximately 2,000 transmission nodes, 2,500 transmission lines, 900 demand nodes, and 300 generation nodes. The needs to be considered over twenty-four successive hourly time periods can reach billions of variables and constraints once the uncertainty in the supply is taken into account.

Credit: Argonne National Laboratory



The combination of computational science and domain-area expertise needed to successfully use HPC is often bought to bear on industrially relevant problems through the industrial outreach and partnership programs in supercomputing at ANL, ORNL, and LBNL. The Accelerating Competitiveness through Computational Excellence program at ORNL, the Private Sector Partnership at LBNL/NERSC, and the Industry Engagement Team at ANL, actively work with companies—from start-ups to industry leaders such as Boeing and GE—on problems that require supercomputing. For example, ORNL partnerships with the private sector have developed novel under-the-hood engine designs to reduce drag and improve automotive fuel economy, simulated wind

## Optimizing Compression Technology on Titan

To meet the DOE goals of reducing the costs of carbon capture and sequestration (CCS), Dresser-Rand has used Titan through both ORNL's ACCEL Program and SC-ASCR's ALCC Program to optimize novel designs for gas compression systems based on aerospace shock wave compression technology.

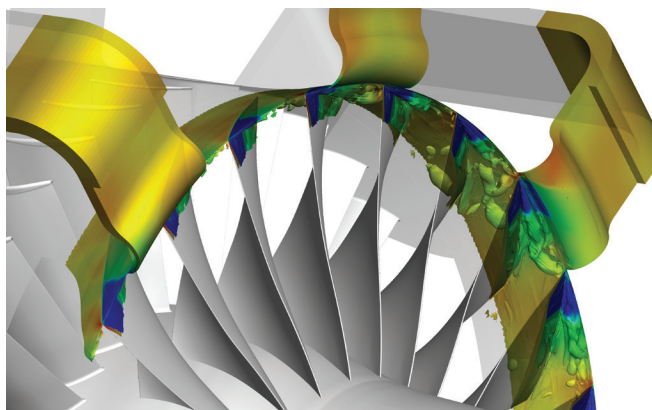
CCS requires energy-intensive pressurization of fossil fuel emissions from power plants to pressures of up to 100 atmospheres. Dresser-Rand estimates its compressor design could reduce capital costs of CCS by 50% and operating costs by 25%. The company's designs are vetted using an ambitious computational method known as intelligently driven optimization, which calculates the best available option within given parameters to predict an optimal design. Using computational fluid dynamics (CFD), the company simulates ensembles containing thousands of designs. A surrogate model approximates the performance of every design perturbation. An evolutionary algorithm is then applied to search the computation space to predict high-performing designs. Once design options are narrowed, the team repeats the optimization process to further refine its search.

To validate its intelligently driven optimization models, the team used Titan to simulate a number of test cases for comparison to a prototype transonic fan stage known as Stage 67, designed and built by the National Aeronautics and Space Administration (NASA) Glenn Research Center. Using the FINE/Turbo CFD code and 1.5 billion grid cells, Titan produced simulation results that not only matched the experimental results, but revealed secondary vortex structures never detected experimentally (Figure 9.15).

These simulations confirmed NASA's experimental finding that a design feature known as tip injection flow control, which recirculates gas flow from downstream of the stage through injectors, can help delay compressor stalls. Ongoing work by Dresser-Rand seeks to use these insights to control stall, which could significantly reduce the energy costs of CCS.

**Figure 9.15** Dresser-Rand is simulating equipment that could enable CCS at a significantly lower cost than that offered by conventional equipment. Below is a visualization from a simulation of NASA Glenn Research Center's transonic fan stage experiment prior to stall.<sup>134</sup>

Credit: Dresser-Rand





turbine blade icing in support of new coatings that allow for installation in colder climates, and optimized compression technology that could dramatically reduce the cost of carbon sequestration technology (see textbox: *Optimizing Compression Technology on Titan*).<sup>133</sup>

HPC within the DOE is not restricted to SC-ASCR facilities. Other DOE laboratories maintain high-performance computers in the pflop range including fifteen of the fastest 150 machines in the world.<sup>130</sup> The National Nuclear Security Administration (NNSA) laboratories have computing needs that require leadership-class computing capability. Lawrence Livermore National Laboratory (LLNL) operates Sequoia (17.17 petaflops) and Vulcan (4.29 petaflops), which have computational capabilities equivalent to Titan and Mira. LLNL makes time on unclassified computing systems, including Vulcan, available to corporate users through the HPC Innovation Center (HPCIC), an alternative to the DOE-SC peer-review-driven models of access. The HPCIC was founded specifically to offer HPC resources and expertise to industrial sponsors whose interests overlap with LLNL's research priorities. The center uses a project-based model where partners pay full cost for projects. LLNL has successfully worked with the California Energy Commission to plan for a future grid with high levels of solar and wind energy resources,<sup>136</sup> and with Navistar, a leading commercial truck manufacturer, to create a more fuel-efficient truck fleet.<sup>137</sup> DOE-EERE's NREL<sup>138</sup> and DOE Office of Fossil Energy's National Energy Technology Laboratory<sup>139</sup> operate their own advanced computing facilities to serve the needs of these programs, and coordinate with SC-ASCR through activities such as the ACTT.

The shared needs of NNSA and SC-ASCR have led to increased collaboration at the technology development and procurement level. Through the Collaboration of Oak Ridge, Argonne, and Livermore (CORAL) Program, SC-ASCR and the NNSA are procuring computers jointly, accelerating technology development while lowering costs. LLNL and ORNL have announced plans to purchase new machines in the 150 petaflop range from IBM. ANL will purchase a different system, as part of a DOE policy to manage technology risk amidst rapid technological change by maintaining architecturally diverse computer systems.<sup>140</sup>

In addition to meeting DOE's advanced computing needs, investments in HPC R&D play a key role in making the resulting technology available to other federal agencies, universities, and the private sector. The National Aeronautics and Space Administration (NASA) and the U.S. Department of Defense have made recent investments in petascale computing hardware. The impact of DOE investment in these areas extends to the private sector as well; approximately thirty of the top 150 HPC systems in the world are in the private sector.

### 9.6.2 Networking and Data Transfer Capabilities

Modern supercomputing depends on data transfer. The code typically is uploaded by a remote user to be compiled and run on the machine, and the resulting data are returned to the remote user. This must be done with a speed and fidelity that far exceeds the capability of commercial data transmission. The Energy Sciences Network (ESnet) is a dedicated DOE network configured for the data transfer requirements of large-scale science.

While ESnet was originally developed to support computational science needs, its capabilities are increasingly used to transfer large experimental data sets. This is a result of the natural increase in data resulting from the study of complex systems in real time through large-scale experiments. DOE's X-ray light and neutron sources, as well as large international projects like the Large Hadron Collider (LHC), are leveraging ESnet's unique capabilities for real-time analysis of experimental results (see textbox: *Photon Science in the Fast Lane*). This has the effect of both improving resource management at high-demand facilities like the LCLS and facilitating collaboration for international experiments like the LHC.

ESnet was the first continental-scale system in the world to handle data at a rate of 100 gigabits per second (Gbps). While this system takes advantage of commercially-developed hardware, the integration of the system to achieve loss-free transmission of large amounts of data has required unique research and development (R&D). To allow integrated use of experimental and computational tools across DOE facilities, additional

## Photon Science in the Fast Lane

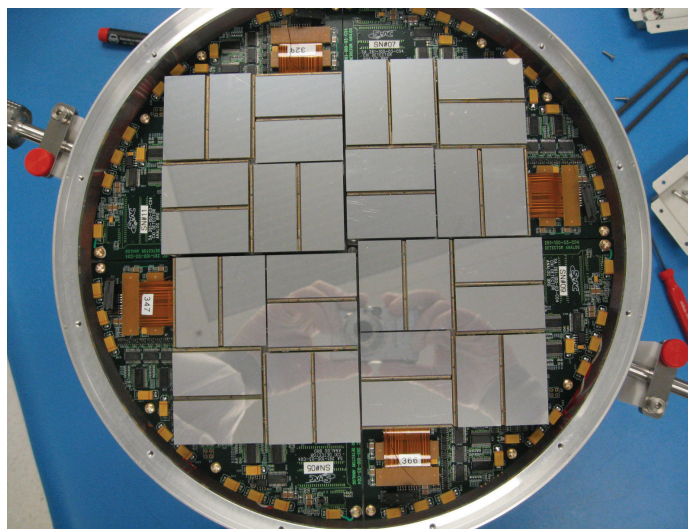
Modern X-ray light sources are instruments uniquely suited to taking pictures at the molecular level. The CSPAD detector (Figure 9.16) at the Coherent X-ray Imaging beamline, one of six beamlines at the LCLS at SLAC, regularly takes 150 terabytes (TB) of data from physical samples to form high-resolution 3D models. These models give scientists an atomic-scale view inside nanoscale phenomena such as photosynthesis and catalysis. However, the computational needs to process these large data sets go far beyond the on-site computational capabilities at SLAC.

In a recent study of photosystem II, a key step in photosynthesis, SLAC researchers used the computational facilities at NERSC to process the raw data into usable models. This, in turn, required rapid and accurate transmission of data. Through ESnet, the light source data was transmitted directly from Cornell-SLAC hybrid Pixel Array Detector (CSPAD) to NERSC at a sustained rate of 10 Gbps. This allowed the data processing to be scaled up, and enabled rapid distribution of the results to collaborators.

The next generation device, LCLS-II, promises dramatically higher repetition rates as well as increased detector resolution. Taking advantage of the higher resolution imaging made possible by the new instrument will necessarily require higher efficiency processing of the larger data sets. Achieving this goal will require the type of full integration of the instruments with data transmission and analysis using high-performance computers like that pioneered by SLAC, ESNet, and NERSC.

**Figure 9.16** The CSPAD camera at the LCLS produces 150 TB molecular “snapshots.”

Credit: SLAC National Accelerator Laboratory



provision is made to link closely located facilities, such as the JGI, LBNL, SLAC, NERSC, LLNL, and the SNL California site.<sup>141</sup> ESNet is continually being upgraded to keep pace with the growth in data produced from both modeling and measurement of complex systems, and has been expanded to provide high-speed data transmission from Europe, including direct links to the European Organization for Nuclear Research (CERN).

### 9.6.3 Nonphysical Infrastructure: Algorithms, Codes, and Personnel

Using supercomputers to simulate complex physical phenomena requires three components in addition to the hardware: 1) numerical algorithms capable of solving the governing equations of the physical phenomena to be simulated; 2) software that implements the algorithm and is written to take advantage of the massively parallel



processing; and 3) personnel who understand the physical nature of the simulation problem, the algorithm mathematics, and the challenges of parallelization.

The first step for any simulation is identifying the physical equations that govern the system. Once identified, a physically accurate algorithm to numerically solve these equations can be created. The computational power required to implement the algorithm varies widely based on the nature of the equations being simulated and the level of resolution (in both space and time) needed to accurately incorporate all the physics. In many cases, problems that appear to be fairly different are governed by similar equations and can be solved by similar numerical algorithms. DOE national laboratories have developed general-purpose, numerical tool boxes that are often used as the building blocks of complex simulations for both scientific and commercial engineering applications.<sup>142</sup> CASL, a DOE Energy Innovation Hub (see Section 9.2.2), has developed tools to model the complex physics inside an operating nuclear reactor, a system not amenable to extensive experimental characterization (see textbox: *Westinghouse–CASL Team Simulates High-Fidelity Next-Generation Light Water Reactors*).<sup>143</sup>

## Westinghouse–CASL Team Simulates High-Fidelity Next-Generation Light Water Reactors

A team representing Westinghouse Electric Company and CASL performed core physics simulations of the Westinghouse AP1000 pressurized water reactor (PWR) core using CASL’s Virtual Environment for Reactor Application (VERA). Westinghouse is deploying the AP1000 worldwide, with eight nuclear power plants currently under construction in China and the United States.

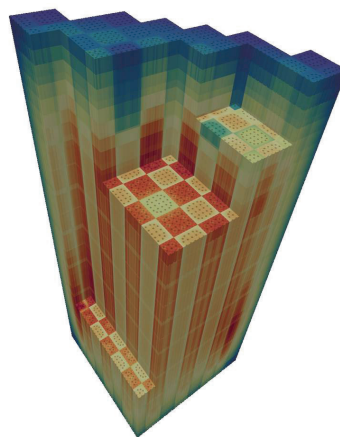
The simulations, performed on Titan at the OLCF, produced 3D, high-fidelity power distributions representing conditions expected to occur during the AP1000 core start-up and used up to 240,000 Titan cores in parallel (Figure 9.17). The results provide insights that improve understanding of core conditions, helping to ensure safe startup of the AP1000 PWR core.

Researchers at CASL have already simulated new reactors under development in South Carolina and Georgia. As computing power increases, CASL will continue to address key nuclear energy industry challenges, including higher fuel burnup and lifetime extension, while also increasing confidence in nuclear safety.

Today, Westinghouse technology is the basis for approximately one-half of the world’s operating nuclear plants, including more than 50% of those in Europe. CASL’s core partners are a strategic alliance of leaders in nuclear science and engineering from government, the private sector, and universities.

**Figure 9.17** Using VERA, CASL investigators successfully performed full core physics power-up simulations of the Westinghouse AP1000 PWR core.<sup>144</sup>

Credit: Consortium for Advanced Simulation of Light Water Reactors





Parallelization of a complex numerical simulation is essential for taking advantage of modern supercomputers and reducing the time required to complete the calculations. Because parallel computing has become the norm for advanced simulation, algorithm development and parallelization can no longer be separate, requiring fundamental understanding of mathematics, computer science and physics that cuts across disciplinary boundaries. DOE's Computational Science Graduate Fellowship was created to ensure that science and technology professionals with advanced computer skills were available for DOE laboratories, as well as for universities and the private sector.<sup>145</sup> Maintaining a core workforce with these skills in DOE national laboratories while also ensuring the same skill sets are available for technology research and development in the private sector and at universities, will enable HPC tools to more broadly impact energy technology development.

Interdisciplinary computational research is also a feature of the SciDAC Program. SciDAC is designed to dramatically accelerate progress in scientific computing to deliver breakthrough scientific results through partnerships of applied mathematicians, computer scientists, and scientists from other disciplines. The current iteration of the SciDAC Program features four institutes: Frameworks, Algorithms, and Scalable Technologies for Mathematics (FASTMath), Quantification of Uncertainty in Extreme Scale Computations (QUEST), Institute for Sustained Performance, Energy and Resilience (SUPER), and Scalable Data Management, Analysis and Visualization (SDAV). These institutes form collaborations with DOE-SC programs to make use of leadership-class computing resources in order to advance scientific frontiers in an area of strategic importance to DOE-SC. These collaborations effectively link scientists with the intellectual resources in applied mathematics and computer science, expertise in algorithms and methods, and scientific software tools at one, or more, SciDAC Institutes. Much of this work translates into energy technology; for instance, the SciDAC partnership with the Office of Fusion Energy Science (SC-FES) has focused on radiation effects in materials, a topic relevant to DOE-NE as well.

#### 9.6.4 Moving toward Exascale Computing

In 2010, SC-ASCR's Advanced Scientific Computing Advisory Committee identified a range of science and technology areas where moving computational power to the exascale (1,000 pflops) had the potential to be truly transformative.<sup>146</sup> These included energy areas such as materials science, combustion, fusion, and fission; related science areas such as climate, biology, and aerodynamics; and nuclear stockpile security. A few of the impacts described in the report are listed:

- **Materials science:** The use of simulation in materials science is limited by the need to capture two length scales: atomistic length scales, which are captured using molecular dynamics, and hydrodynamic effects, which are captured using continuum methods. Bridging these length scales for realistic materials requires simulation of billions of individual atoms over extended timescales, which can only be accomplished using exascale computing.
- **Combustion:** Simulation of combustion is limited by challenges similar to those in materials science: the need to combine multiple physics (e.g., chemical reactions, turbulent fluid mechanics, and heat transfer) into one simulation that bridges length scales from the molecular to the continuum. Exascale simulation enables the most accurate simulation methods to be used for all of the physical phenomena, enabling both new scientific discoveries and design of more efficient combustion systems.
- **Climate:** Exascale computing will enable planet-level climate simulations to move from a grid scale of 100 kilometers (km) to a scale of 3–5 km. This will greatly improve the ability of these simulations to predict the local impacts of climate change.<sup>147</sup>
- **Aerodynamics:** Current aerodynamic simulations for both wind energy and aircraft are limited by one of the classic problems of fluid mechanics: resolving turbulent length scales. Exascale computing will allow simulation of these systems to move from Reynolds-averaged Navier-Stokes models, to large-eddy simulations that capture turbulence with a much greater physical fidelity.<sup>148</sup>



Because of the key role scientific computing plays in DOE's science, energy, and stockpile security missions, SC-ASCR is actively researching both the hardware and software technologies needed to push high-performance computing to the exascale. Key hardware challenges include achieving a massive reduction in power consumption, creating memory systems capable of handling the large amounts of new data produced, and managing the large data flows inside the computer. Major software challenges include creating scalable system software and programming systems, and creating resiliency when individual components in an extreme scale machine fail. Using the new machine architecture will require adapting existing algorithms to work at the exascale and developing new methods for the scientific problems that now become solvable because of exascale computing. Finally, the large amounts of data produced require new approaches to visualizing and processing the data.

One strategy for addressing these challenges is co-design, where the requirements of the scientific problem are considered when first designing the computer system hardware and software. This approach requires coordination among hardware architects, system software developers, domain scientists, and applied mathematicians. Three co-design centers, all targeting problems related to energy—materials in extreme environments, advanced nuclear reactors, and combustion—have already begun preparing simulation methods for this new computational environment.<sup>149</sup> Co-design will ensure that the machines are suitable for DOE applications and allow exascale systems to rapidly be deployed in the development of energy technology.

## 9.7 Supporting Technologies and Future Energy Sources

Particle accelerators and colliders were developed more than half a century ago to be the workhorse experimental tools supporting development of nuclear fission-based weapons and energy systems and for fundamental discovery in high energy and nuclear physics. Silicon-based detectors were developed soon after to allow researchers to record the aftermath of particle collision events and reveal new fundamental physics.

Today, these technologies form the backbone of the suite of X-ray light and neutron sources and detectors that have enabled the advances in materials science, chemistry, biology, and technology described in this chapter. As they have matured, these technologies have expanded beyond the laboratory, with many applications outside the discovery space, including for medicine, security, environmental stewardship, and manufacturing.

Future experimental tools for scientific discovery and technology research, development, demonstration, and deployment (RDD&D) will undoubtedly be based on cutting edge experimental and computational developments in the modern high energy and nuclear physics communities. This effort is highly interdisciplinary, requiring development of novel materials and synthesis techniques coupled with modeling and simulation. The following four sections review some of the technologies in development for pure scientific research that are poised to become the next generation of experimental tools for energy science and technology.

The first two sections present current developments in accelerator and detector science supported by the Offices of High Energy Physics (SC-HEP), Nuclear Physics (SC-NP), and SC-BES. The motivation for new technology development, the status of selected new technologies, the user facilities that support this work, and the broader applications to technology RDD&D, are discussed.

In the third section, the state of isotope science is presented, focusing on current and future production and on applications to science and technology. Isotopes are critically important for science, energy, manufacturing, health, and national security. Their production is intimately linked to technology development, including accelerators.

The final section looks at development of nuclear fusion as a future energy source. Developing a viable nuclear fusion power device depends on building a foundation of knowledge in plasma science. Development of this foundation is enabled by new experimental and computational tools. This section describes current research

into magnetically confined burning plasmas as the basis for a future fusion energy source, discusses the facilities being leveraged to understand and control these plasmas, and describes the interdisciplinary nature of modern fusion research.

### 9.7.1 Accelerator Science

The next generation of particle accelerators is enabling discovery science across the physical and biological sciences. This is evidenced by the highly collaborative character of accelerator research and development carried out in DOE-SC. Each of the SC-HEP, SC-NP, and SC-BES programs provide support for accelerator R&D specific to their mission needs, including accelerator R&D aimed at improving performance of operating facilities and R&D needs for the development of next-generation facilities within their programs.

SC-HEP is the steward for long-term accelerator R&D and facilitates development of new technologies that enable breakthroughs in accelerator size, cost, beam intensity, and control that are critical to the development of future large-scale particle accelerators<sup>150</sup> and upgrades to existing colliders<sup>151</sup> to reveal new fundamental physics at the energy and intensity frontiers.<sup>152</sup> In SC-NP, accelerators are at the heart of research at all energy levels.<sup>153</sup> Accelerators are also used by the Isotope Program (see Section 9.7.3) to produce radio-isotopes that are in short supply and critical for medicine, science, and national security applications. SC-NP supports development in targetry and accelerator science aimed at improving yields and efficiency of isotope production, as well as capabilities for accelerator-based isotope production. The goals for materials science research in SC-BES—understanding, predicting, and controlling materials properties through characterization of materials composition, structure, and behavior under external perturbation—will see benefits from accelerator developments that increase average photon flux and spatial and temporal coherence in X-ray lasers, as well as higher neutron flux enabled by higher proton currents.

The mission needs articulated in the preceding paragraph can be summarized by the grand challenges for accelerator research—high energy, high power, high gradient, new acceleration methods, beam emittance, brightness and coherence, and compactness.<sup>154</sup> Of critical importance across all three programs is the collaborative development of superconducting radio frequency (SRF) technology and new superconducting magnets.<sup>155</sup> These enabling technologies have the potential to dramatically increase the power, intensity, and efficiency of accelerated beams. SRF technology has already enabled a dramatic increase in the number of particle collisions at the Relativistic Heavy Ion Collider at BNL,<sup>156</sup> and will enable the Continuous Electron Beam Accelerator Facility at the Thomas Jefferson National Accelerator Facility (TJNAF) to double beam energy without new infrastructure development.<sup>157</sup> SRF technology in development at TJNAF and Fermi National Accelerator Laboratory (FNAL) is at the heart of the SC-BES LCLS upgrade (LCLS-II), which will increase brightness and expand the X-ray photon energy range.<sup>158</sup> These developments are enabled by the FNAL Advanced Superconducting Test Accelerator, a fabrication and test facility for superconducting magnets and SRF technology, and the Technology and Engineering Development Facility at TJNAF.<sup>159</sup>

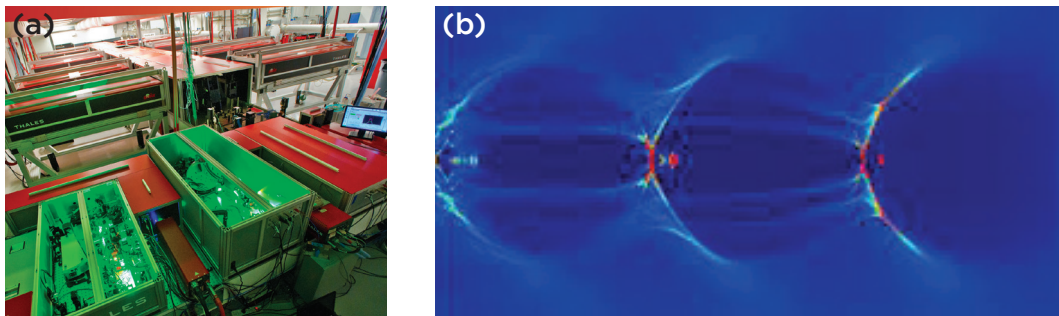
Pushing the frontiers of particle physics requires increasingly higher energies. With current technology, this means larger, more expensive machines. Reducing both the footprint of future accelerators and the cost of fabrication is an important part of the effort to develop plasma wakefield accelerators that can accelerate charged particle bunches to very high energies in a fraction of the distance of traditional, radio frequency-based accelerators.<sup>160</sup> The plasmas are created by very high power lasers or by an accelerated electron (or positron) bunch. The Berkeley Lab Laser Accelerator Center (BELLA), an SC-HEP-supported facility, leverages uniquely powerful optical lasers<sup>161</sup> to produce accelerating gradients up to 100 gigaelectron volts per meter (GeV/m) (see textbox: *Record-Breaking Electron Energies from a Laser-Driven Accelerator*).<sup>162</sup> The need for cutting-edge pulsed lasers leads to a symbiotic relationship in laser technology R&D.<sup>163</sup> The Facility for Advanced Accelerator Experimental Tests at SLAC leverages highly accelerated electrons from the SLAC linac to generate plasma wakefields that accelerate the charged particle bunches at 50 GeV/m, more than 3,000

## Record-Breaking Electron Energies from a Laser-Driven Accelerator

Using one of the most powerful lasers in the world, a team of LBNL researchers accelerated subatomic particles to the highest energies ever recorded from a compact accelerator. This setup is known as a laser-plasma accelerator (LPA), an emerging class of particle accelerators that physicists believe can shrink both the cost and size of traditional, miles-long accelerators to machines that can fit on a table. The team used the petawatt laser system at BELLA (Figure 9.18a) to create density waves in a plasma and accelerate electrons in the plasma to 4.2 GeV over a length of only nine centimeters. This energy is the same order of magnitude of electrons operating in today's synchrotron light sources that are hundreds of meters in circumference. Simulations conducted at NERSC (Figure 9.18b) were critical in determining the optimum plasma conditions needed to guide the laser pulse. The results are an important step toward realizing two goals of LPA research: a teraelectron volt-scale electron-positron collider for the high-energy physics community, and laboratory-scale, X-ray free electron lasers.

**Figure 9.18** The BELLA laser (a) is a Ti:Sapphire chirped-pulse amplification laser capable of pulsed petawatt level peak power at a frequency of a single hertz. The work was selected as one of ten Best Physics Papers of 2014 by Scientific American. Simulations (b) run at NERSC show a laser plasma wakefield as it evolves in a nine-centimeter long tube of plasma. The charge “wake” (three are shown) allows electrons to “ride” the wake to greater and greater energies.<sup>171</sup>

Credit: Lawrence Berkeley National Laboratory



times the energy gradient of the linac itself. Finally, the Accelerator Test Facility, a scientific user facility at BNL, provides high brightness electron beams and a high-power picosecond CO<sub>2</sub> laser, synchronized to the electron beam, for advanced compact accelerator research.<sup>164</sup> Both of these technologies could form the basis of future X-ray free electron laser user facilities; potentially extend the energy range of existing light sources; and simultaneously provide researchers with pulsed laser irradiation and charged particles for additional studies within the same facility.<sup>165</sup> In addition, plasma-based technologies may enable more compact accelerators for medical or security applications.

Beyond enabling fundamental science broadly across DOE-SC programs, accelerator science has applications in energy technology and the environment. Currently, there are more than 30,000 accelerators in use for medicine, manufacturing, security, and science.<sup>166</sup> In the private sector, applications of accelerated electron beams often center on modification of materials properties. Electron beams are used in the cross-linking of polymers, for surface treatments, and for medical sterilization, among others. Accelerated ion beams are critical to the semiconductor manufacturing industry, enabling doping of silicon-based microelectronic devices, and

to the medical device industry, where ion implantation is used to harden materials. Potential new applications of ion acceleration include doping of heterogeneous catalysts and electrodes in energy storage and conversion devices.<sup>167</sup> More generally, replacement of traditional, energy intensive thermal processes with more effective accelerator based technology could realize dramatic energy savings.<sup>168</sup> Greater application of accelerators in the manufacturing, medical, and other industries will require further education of accelerator benefits, as well as cost-effective, compact, and higher-intensity accelerators that can be utilized by individuals or small teams of users.

Electron beam accelerators have been demonstrated as an energy-efficient approach to remediation of waste streams, including flue gas from coal-fired power plants and waste water.<sup>169</sup> In the context of basic science, ion acceleration can simulate the effects on materials of high particle flux from future nuclear fission or fusion devices. Future discovery science accelerators are likely to make increasing use of continuous-wave, high-power, and high-energy beams. Such applications require low loss, high-energy efficiency, high stability, minimal downtime, and lower costs for deployment. The R&D to develop such accelerators in support of DOE-SC's discovery science mission is applicable to the broader DOE energy and environmental missions. The SC-HEP Accelerator R&D Stewardship Program makes modest investments in translational R&D to adapt accelerator technologies for use in energy and environmental applications, among others, and to facilitate private sector collaboration with DOE national laboratories to develop such applications.<sup>170</sup>

### 9.7.2 Detector Science

X-ray and neutron scattering scientific user facilities operated by SC-BES rely on state-of-the-art detector technology in order to provide experimental data to their large user base. Advances in detector technology are just as critical to the capabilities of these facilities as improvements to the X-ray and neutron sources.

There is a long history of important advances in detector technology first appearing in high-energy physics applications and then being used for other purposes, such as in X-ray scattering at the light source facilities. For example, the particle physics community embraced silicon detectors in the 1970s, and silicon-based hybrid pixel detectors were used at the LHC. This was the first large-scale usage of this detector technology.<sup>172</sup> Today, every major synchrotron light source uses silicon-based detector technology.<sup>173</sup>

In 2012, SC-BES convened a workshop on neutron and X-ray detectors.<sup>174</sup> The resulting workshop report noted that advances in detector technology would be necessary in order to fully take advantage of improvements to X-ray and neutron sources. For example, for an X-ray source of increased brightness, the facility would benefit from more efficient detectors, as well as detectors with faster frame rates and wider dynamic range. These advancements in detector technology will provide new capabilities to the entire user community, such as the capture of motion on very fast timescales of irreversible phenomena.

The workshop report identified several other key parameters for improved detectors, including readout speed, detector efficiency, energy resolution, and dynamic range. In addition, the report noted several priority research directions.<sup>175</sup> One of the highest priorities identified was a replacement for helium-3 (He-3) in neutron detectors (see textbox: *New Developments in Neutron Detection: Addressing the Shortage of He-3*). He-3 is a rare byproduct of tritium decay and has been facing shortages for many years due, in part, to significantly increased usage for national security applications. This has limited the availability of He-3 for the neutron detectors used at neutron scattering facilities. Possible alternatives include lithium-6-doped scintillators and boron-10-doped silicon; however, efficiency improvements will be needed to make these alternatives viable.

### 9.7.3 Isotope Science

The DOE Isotope Development and Production for Research and Applications subprogram (IDPRA or DOE Isotope Program), managed by the SC-NP, supports the production, distribution, and development of production techniques for radioactive and stable isotopes in short supply and critical to the nation.<sup>176</sup> Isotopes



## New Developments in Neutron Detection: Addressing the Shortage of He-3

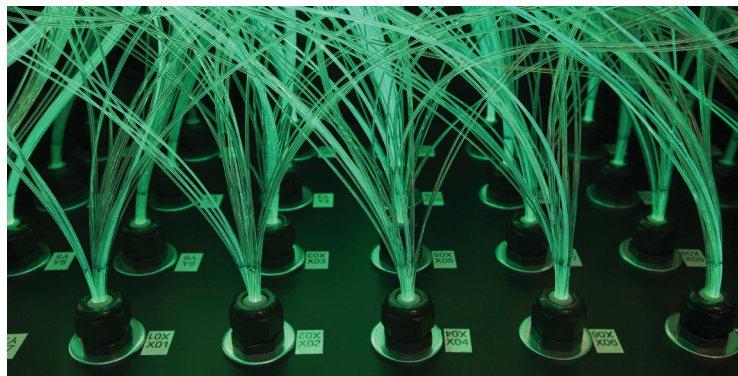
Major advancements in the instrumentation at neutron scattering centers worldwide over the past few years have been accompanied by the increased use of large-scale neutron detectors for enhanced versatility and efficiency of these machines. Additionally, neutron detection for industrial and national security applications is a growing need. Historically, a rare isotope of helium gas, He-3, has been used in these detectors, and the increased demand for neutron detectors has created an extreme shortage of this isotope. This has led to an intense worldwide effort to find alternative types of neutron detectors.

One of the very promising new developments is the wavelength-shifting fiber scintillator detector. This is based on a material that “scintillates,” meaning that it emits light when struck by a neutron. The scintillating material emits a blue glow from the impact of a neutron, which is channeled into optical fibers that contain a special dye that converts the blue light created by the scintillator material into longer-wavelength green light (thus the name “wavelength-shifting” fibers) as shown in Figure 9.19. This green light travels through the optical fiber to an array of light detectors called photomultipliers, which convert the green light into electrical pulses that are then easily processed by conventional counting electronics. Proper arrangements of crossed fibers along with electronic decoding hardware further allows the location of the neutrons that strike the scintillator to be determined with an accuracy and counting efficiency that rivals that of current He-3 detectors.

Scientists at the SNS (see Section 9.4.2) have developed arrays of these wavelength-shifting fiber detectors and have deployed them on several neutron scattering instruments with excellent results. Due to the universal applicability of this technology for neutron detection, the SNS has licensed this detector technology to General Electric Reuter Stokes as a commercial product.

**Figure 9.19** Optical fibers give off a green glow as they carry light pulses from the scintillator material to an external photomultiplier counting array in the wavelength-shifting optical fiber neutron detector.

Credit: Oak Ridge National Laboratory



are commodities of strategic importance and are essential for energy exploration and innovation, medical applications, national security, manufacturing, and basic research. The subprogram also supports R&D efforts associated with developing new and more cost-effective and efficient production and processing techniques.

The DOE Isotope Program currently supports two accelerator facilities: the Isotope Production Facility at LANL<sup>177</sup> and the Brookhaven Linac Isotope Producer facility at BNL.<sup>178</sup> Reactor-based isotope production is supported at the HFIR (see section 9.4.2) and the Advanced Test Reactor at INL.<sup>179</sup> The Isotope Program also supports the distribution of isotopes with broad importance for energy technology from two NNSA-stewarded facilities: the Savannah River Site Tritium Facilities, (the only domestic supplier of He-3)<sup>180</sup> and the Y-12 National Security Complex (which processes several lithium isotopes).<sup>181</sup> The DOE national laboratory production capacity is augmented by universities performing smaller-scale and unique radioisotope production and R&D.<sup>182</sup> The DOE Isotope Program has made investments at several universities to develop new production capabilities and perform related R&D. The business aspects of the Isotope Program and customer relations are managed by the National Isotope Development Center.<sup>183</sup>

Two of the largest sectors for isotope applications are medicine and national security. In medicine, radionuclides produced by the DOE Isotope Program are used for medical diagnostics and therapeutics, and to support clinical trials of promising new treatments of cancer.<sup>184</sup> The Isotope Program is working to establish large-scale production capability of alpha emitters for cancer therapy, which is a high priority for the medical community, as treatment is limited to only the cancerous tissue in the vicinity of the isotope.<sup>185</sup> In national security, He-3 based neutron detectors are used to monitor cargo entering the United States. Additionally, radioisotopes are used as both calibration standards and sources for nondestructive gamma-ray-based systems for nuclear materials monitoring. Isotopes are also a core component of the current computer-based weapons testing program, providing crucial experimental data to validate computational models.

Both stable and radioisotopes have applications across the physical sciences and engineering sectors. The radioisotopes berkelium-249 and californium-251 are being used to synthesize new super heavy elements and explore the hypothesized “island of stability” in the transuranic elements. In chemistry, biology, and materials science, stable isotopes are a critical tool used to study materials properties (geometric and electronic structure) and (bio) chemical reaction mechanisms. Rare isotopes are at the core of fundamental studies of nuclear physics conducted at the Argonne Tandem Linac Accelerator System at ANL and the future Facility for Rare Isotope Beams at Michigan State University. Silicon-32 is used in oceanographic studies relevant to climate change.

Isotopes are used extensively in the applied R&D, engineering, and manufacturing sectors, often providing irreplaceable capabilities. Besides the use of uranium for reactor fuel, the nuclear power sector utilizes more rare isotopes for selected activities, including californium-252 as a source of neutrons for reactor startup.<sup>186</sup> Isotope-based neutron methods—probes, detectors, and analysis—are employed throughout the energy technology and manufacturing sector. The oil and gas industry uses neutron well-logging, a technique that combines a radioisotope-based neutron source (typically californium-252) with a He-3 neutron detector, to ascertain the hydrocarbon composition of a new well. Gamma radiography using selenium-75, cobalt-60, or iridium-192, allows manufacturers and engineers to assess the integrity of welds for high-pressure vessels and pipelines and determine the extent of corrosion in metals.

The DOE Isotope Program is re-establishing a domestic capability for stable isotope enrichment production and distribution at ORNL (see textbox: *Reestablishing Broad-Scale Stable Isotope Enrichment in the United States*). This is an important asset for the United States, which is currently dependent on foreign sources for many of its stable isotopes.<sup>187</sup> The United States’ stable isotope reserve is managed by the DOE Isotope Program, and many



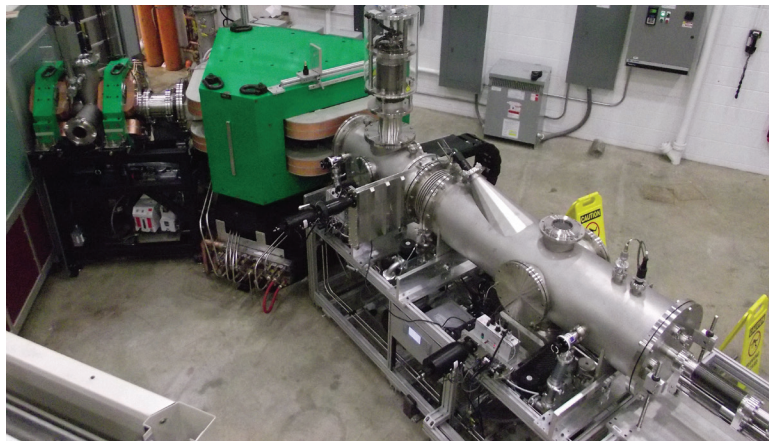
## Reestablishing Broad Scale Stable Isotope Enrichment in the United States

From 1945 to 1998, the ORNL calutrons were used to enrich stable isotopes for research and applications. At least 233 naturally occurring isotopes of the first eighty-two elements in the periodic table were enriched during this time. The resulting stable isotope inventory is stewarded by the DOE Isotope Program.

Since 2009, the DOE Isotope Program has supported the development of a modernized research scale electromagnetic isotope separator (EMIS) capability, coupled with small modular centrifuges for stable isotope enrichment at ORNL. The capability is designed to be expandable to produce larger quantities of enriched stable isotopes should the need arise within the federal complex.

**Figure 9.20** The EMIS for Stable Isotope Enrichment at ORNL

Credit: Oak Ridge National Laboratory



will no longer be available after depletion of their supply. The development of this capability was recommended by the joint DOE-National Science Foundation Nuclear Science Advisory Committee and will impact a broad variety of applications including medicine, basic research, energy, and national security.

### 9.7.4 Fusion Energy

Research in SC-FES is developing the scientific basis for a future fusion energy source through support for a hierarchy of topics from basic research to the development of proxies for a self-sustaining burning plasma device.<sup>188</sup> The portfolio includes fundamental research in plasma science, the physics of magnetic confinement of plasmas, two large U.S.-based user facilities, collaboration with major international magnetic confinement devices, strong efforts in theory, modeling, and whole-device simulation, and participation in the construction of the International Thermonuclear Experimental Reactor (ITER) experiment—a facility designed to create a burning plasma operating at a reactor-like scale.<sup>189</sup>

Today, the burning plasma state is approximated with scaled laboratory experiments and computer simulations. The DIII-D National Fusion Facility (DIII-D) is a scientific user facility located at General Atomics and is the largest magnetic fusion research experiment in the United States. It can magnetically confine plasmas at temperatures relevant to burning plasma conditions. Research results from DIII-D will help optimize the tokamak approach to magnetic confinement fusion (see textbox: *Innovative Methods for Controlling Heat Bursts*).<sup>190</sup> The National Spherical Torus Experiment (NSTX-U) scientific user facility at the Princeton Plasma



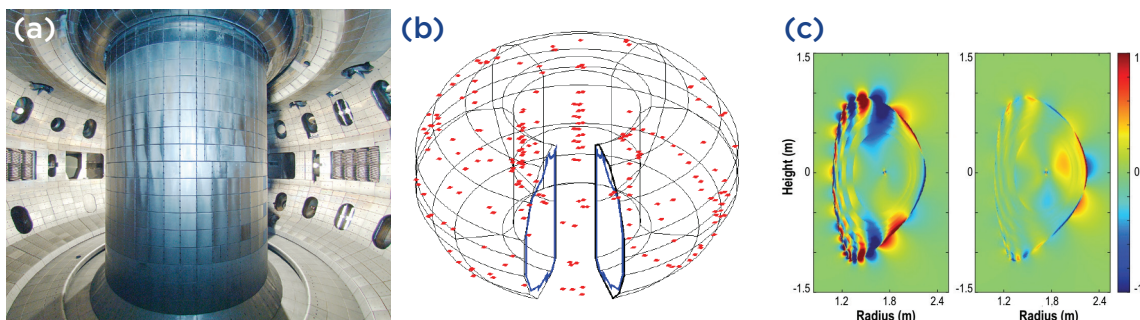
## Innovative Methods for Controlling Heat Bursts

Edge localized modes (ELMs) are sudden intense bursts of heat that can erupt from the edge of high-performance fusion plasmas confined in a tokamak with doughnut-shaped magnetic fields. ELMs have the potential for severely damaging the vessel containing the plasma, and have been a major concern for the worldwide fusion research program. Scientists at the DIII-D National Fusion Facility (DIII-D) (Figure 9.21a) have invented a technique for controlling ELMs by applying small, localized 3D magnetic perturbations. This novel technique has revolutionized the science of mode control, and the U.S. fusion program is now designing similar control coils for the International Thermonuclear Experimental Reactor (ITER) fusion facility under construction in Europe.

Quite recently, U.S. scientists have made a major breakthrough in gaining a detailed understanding of exactly how these magnetic perturbations control the ELM bursts. A multi-institutional team of researchers—including scientists from General Atomics, Princeton Plasma Physics Laboratory, ORNL, Columbia University, Australian National University, the University of California-San Diego, the University of Wisconsin-Madison, and several other groups—discovered that the 3D perturbations produce a ripple in the magnetic field near the plasma edge, allowing more heat to leak out smoothly at just the right rate to avert the intense heat bursts. Researchers applied the magnetic fields by running electrical current through coils around the plasma. A new system of approximately one hundred pickup sensors (Figure 9.21b) then detected the plasma response, much as the microphone on an electric guitar picks up string vibrations. These results suggest that this technique can be optimized for eliminating ELMs in ITER and future fusion devices (Figure 9.21c), thus providing a solution to overcoming a persistent barrier to sustained fusion reactions.

**Figure 9.21** (a) Inside the DIII-D Tokamak. (b) The position of approximately one hundred magnetic sensors (red dots) recently installed around the plasma. (c) Simulations of the cross-section of the DIII-D plasma show the response typical of non-suppression (c, left) and ELM suppression (c, right), in agreement with experimental measurements.<sup>194</sup>

Credit: (a), (b) DIII-D/General Atomics (c) Reprinted with permission from Paz-Soldan, C.; Nazikian, R.; Haskey, S.R.; Logan, N.C.; Strait, E.J.; Ferraro, N.M.; Hanson, J.M.; King, J.D.; Lancot, M.J.; Moyer, R.A.; Okabayashi, M.; Park, J-K; Shafer, M.W.; Tobias, B.J. "Observation of a Multimode Plasma Response and its Relationship to Density Pumpout and Edge-Localized Suppression," *Physical Review Letters* (114:10), p. 105001-1-5. Copyright 2015 by the American Physical Society.





Physics Laboratory has a more compact spherical torus configuration that could lead to the development of smaller fusion devices. With the recent upgrade, the NSTX-U facility is the world's highest-performance spherical torus device. These two plasma science user facilities are complementary, with their unique geometries allowing both to serve as world-leading scientific platforms for fundamental burning plasma science.<sup>191</sup>

Development of sustained burning plasma fusion devices requires a collaborative research effort across the experimental and computational arenas. The materials used in a magnetic confinement device must withstand enormous heat and neutron fluxes, and fluxes can qualitatively change materials strength and characteristics due to atom displacement. The development of new materials that can tolerate the extreme conditions of a burning plasma environment requires leveraging the tools of synthesis, fabrication, characterization, and computation described earlier in this chapter. The SC-FES program is an active participant in SC-ASCR's multi-institutional and interdisciplinary SciDAC Program, leveraging the leadership-class computing resources of DOE-SC to address challenges across the fusion science space, including magnetic confinement and computational fusion materials science.<sup>192</sup> These simulations provide the basis for comparison to detailed measurements and increasingly represent tools for discovery.

The fusion enterprise supports, and is in turn supported by, broader research in plasma science that targets the understanding of an enormous range of phenomena, from those occurring at the galactic scale to plasma science applicable to the world of microelectronic and nanoscale fabrication.<sup>193</sup> Plasma science supported by SC-FES is central to many science and technology issues, from formation of galactic jets and accretion of stellar material around black holes to optimization of processes in the semiconductor industry and development of technologies deployed for national defense, medical applications, and homeland security. This research is carried out by universities, private R&D groups, and DOE national laboratories.

## 9.8 Conclusion

This chapter describes the suite of scientific user facilities and multidisciplinary research centers for the nation that are currently supported by DOE. The chapter also provides a small sample of the scientific research that these facilities enable. These examples illustrate the potential of fundamental scientific research to impact the energy technologies described throughout this report.

The analysis of R&D needs presented in the preceding chapters of this report reveal two crosscutting scientific themes: 1) new materials; and 2) modeling, simulation, and analytics. Through careful strategic planning, DOE-SC is well-positioned to continue to support key scientific research that will lead to the necessary advances in these areas. Efforts led by the SC-BES program to explore the opportunities in materials science have led, for example, to the report *Computational Materials Science and Chemistry*,<sup>195</sup> which looked at how simulation can be used to accelerate material discovery and understanding, and *From Quanta to the Continuum: Opportunities in Mesoscale Science*,<sup>196</sup> which looked at how emergent mesoscale phenomenon can be harnessed for science and energy.

Future developments in both computational materials science and in SC-BES scientific user facilities, specifically the LCLS-II and the APS upgrade, are important to the materials science community. Sustained investment in these areas can benefit a wide variety of scientific disciplines, and can address many of the energy-related materials science needs described in the preceding chapters.

Similarly, advanced modeling, simulation, and large-scale data analytics are a priority for meeting national science and energy needs. The investments in new, more powerful computers, through the CORAL collaboration, at ORNL, ANL, and LLNL, and in exascale computing, are vital for science and technology development moving forward. It is critical to develop and disseminate new computational tools across its mission areas. Enabling the effective use of high-end computation across the entire science, energy, and nuclear security portfolio—one of the core missions of the ACTT—will facilitate addressing many of the energy-related problems discussed in this report.

# Supplemental Information

A Comparison of Research Center Funding Modalities  
High-Performance Computing Capabilities and Allocations  
User Facility Statistics  
Examples and Case Studies

[See online version.]

## Endnotes

- <sup>1</sup> More information about the National Nanotechnology Initiative can be found at <http://www.nano.gov>.
- <sup>2</sup> “Nanoscience Research for Energy Needs.” Report of the National Nanotechnology Initiative Grand Challenge Workshop, March 16-18, 2004. Available at: [http://science.energy.gov/~media/bes/pdf/reports/files/nren\\_rpt.pdf](http://science.energy.gov/~media/bes/pdf/reports/files/nren_rpt.pdf).
- <sup>3</sup> “From Quanta to the Continuum: Opportunities for Mesoscale Science.” Report for the Basic Energy Sciences Advisory Committee Mesoscale Science Subcommittee, September 2012. Available at: [http://science.energy.gov/~media/bes/pdf/reports/files/OFMS\\_rpt.pdf](http://science.energy.gov/~media/bes/pdf/reports/files/OFMS_rpt.pdf).
- <sup>4</sup> Bioenergy Research Centers, U.S. DOE, Office of Science, Office of Biological and Environmental Research, February 2014. See <http://genomicscience.energy.gov/centers/BRCs2014HR.pdf>.
- <sup>5</sup> For more on predictive theory and modeling of materials, see “Computational Materials Science and Chemistry: Accelerating Discovery and Innovation Through Simulation-Based Engineering and Science.” Report of the Department of Energy Workshop on Computational Materials Science and Chemistry for Innovation, July 26-27, 2010. Available at: [http://science.energy.gov/~media/bes/pdf/reports/files/cmssc\\_rpt.pdf](http://science.energy.gov/~media/bes/pdf/reports/files/cmssc_rpt.pdf).
- <sup>6</sup> The DOE-SC supports basic research across six programs—Basic Energy Sciences, Biological and Environmental Research, Advanced Scientific Computing Research, High Energy Physics, Nuclear Physics, and Fusion Energy Sciences. Each of these programs is subdivided into multiple core scientific disciplines. Descriptions of the core research programs are available at <http://science.energy.gov/programs/>.
- <sup>7</sup> SNS (see Section 9.4.2) was developed through collaboration of ANL, BNL, LBNL, LANL, ORNL, and TJNAL. When completed in 2006, it became the world’s most powerful pulsed neutron source.
- <sup>8</sup> A table comparing the three types of multi-institutional research centers across institutional participation, award length and management, funding level, and research focus is provided in Supplemental Information (section 9A).
- <sup>9</sup> An interactive map of DOE-SC grant award data and cooperative agreements for FY 2014 is available at <http://science.energy.gov/universities/interactive-grants-map/>. This information can be parsed in multiple ways, including by DOE-SC program, by institution (e.g., educational institution, for-profit organization, small business, or other federal agency), or by program area/topic (e.g., catalysis science, physical behavior of materials, or solar photochemistry).
- <sup>10</sup> Examples of Basic Research Needs (BRN) workshops are Basic Research Needs for the Hydrogen Economy, Basic Research Needs for Solar Energy Utilization, Basic Research Needs for Solid-State Lighting, and Basic Research Needs for Advanced Nuclear Energy Systems. A hyperlinked list of all the BRN reports is found in Supplemental Information (Chapter 1).
- <sup>11</sup> The five SC-BES grand challenges are presented in “Directing Matter and Energy” available at: [http://science.energy.gov/~media/bes/pdf/reports/files/gc\\_rpt.pdf](http://science.energy.gov/~media/bes/pdf/reports/files/gc_rpt.pdf). The grand challenges addressed by current and former EFRCs are provided at <http://science.energy.gov/bes/efrc/research/grand-challenges/> and <http://www.science.energy.gov/bes/efrc/history/grand-challenges>.
- <sup>12</sup> Each BRN workshop identified a set of priority research directions for the respective scientific community.
- <sup>13</sup> The full list of EFRCs, partnering institutions, and research descriptions is available at <http://www.science.energy.gov/bes/efrc/centers>. Technical summaries for each EFRC are available at [http://science.energy.gov/~media/bes/efrc/pdf/technical-summaries/ALL\\_EFRC\\_technical\\_summaries.pdf](http://science.energy.gov/~media/bes/efrc/pdf/technical-summaries/ALL_EFRC_technical_summaries.pdf).
- <sup>14</sup> The EFRCs have established a community Web site at <http://www.energyfrontier.us/> to share research and facilitate communication between the EFRCs, researchers, and SC-BES.



- <sup>15</sup> (a) Plonka, A. M.; Banerjee, D.; Woerner, W. R.; Zhang, Z.; Nijem, N.; Chabal, Y. J.; Li, J.; Parise, J. B. "Mechanism of Carbon Dioxide Adsorption in a Highly Selective Coordination Network Supported by Direct Structural Evidence." *Angewandte Chemie International Edition* (52:6), 2013; pp 1692–1695. Available at: <http://onlinelibrary.wiley.com/doi/10.1002/anie.201207808/abstract>; (b) McDonald, T. M.; Mason, J. A.; Kong, X.; Bloch, E. D.; Gygi, D.; Dani, A.; Crocellà, V.; Giordanino, F.; Odoh, S. O.; Drisdell, W. S.; Vlaisavljevich, B.; Dzubak, A. L.; Poloni, R.; Schnell, S. K.; Planas, N.; Lee, K.; Pascal, T.; Wan, L. F.; Prendergast, D.; Neaton, J. B.; Smit, B.; Kortright, J. B.; Gagliardi, L.; Bordiga, S.; Reimer, J. A.; Long, J. R. "Cooperative Insertion of CO<sub>2</sub> in Diamine-appended Metal-organic Frameworks." *Nature* (519), 2015; pp 303–308. Available at: <http://www.nature.com/nature/journal/v519/n7543/full/nature14327.html>; (c) Herm, Z. R.; Wiers, B. M.; Mason, J. A.; van Baten, J. M.; Hudson, M. R.; Zajdel, P.; Brown, C. M.; Masciocchi, N.; Krishna, R.; Long, J. R. "Separation of Hexane Isomers in a Metal-Organic Framework with Triangular Channels." *Science* (340), 2013; pp 960–964. Available at: <http://www.sciencemag.org/content/340/6135/960.full?sid=14f2af9d-dc94-4005-8ba7-58a97fe59d54>; (d) Bloch, E. D.; Queen, W. L.; Krishna, R.; Zadrozny, J. M.; Brown, C. M.; Long, J. R. "Hydrocarbon Separations in a Metal-Organic Framework with Open Iron(II) Coordination Sites." *Science* (335), 2012; pp 1606–1610. Available at: <http://www.sciencemag.org/content/335/6076/1606.full?sid=cb7c8938-40a3-453d-b45b-258787d9a0a8>. (e) Xiao, D. J.; Bloch, E. D.; Mason, J. A.; Queen, W. L.; Hudson, M. R.; Planas, N.; Borycz, J.; Dzubak, A. L.; Verma, P.; Lee, K.; Bonino, F.; Crocellà, V.; Yano, J.; Bordiga, S.; Truhlar, D. G.; Gagliardi, L.; Brown, C. M.; Long, J. R. "Oxidation of Ethane to Ethanol by N<sub>2</sub>O in a Metal-Organic Framework with Coordinatively Unsaturated Iron(II) Sites." *Nature Chemistry* (6), 2014; pp. 590–595. Available at: <http://www.nature.com/nchem/journal/v6/n7/full/nchem.1956.html>.
- <sup>16</sup> In addition to JCAP and CASL, a third hub, the Energy Efficient Buildings (EEB) Hub, was stood up in 2009. However, the scope of work and funding level was reduced in 2014, and the Hub classification was removed to reflect this change. The research center was renamed the Consortium for Building Energy Innovation (CBEI) and has been integrated into the main DOE-EERE program. It is currently developing technology systems to improve energy efficiency in existing small- and medium-sized commercial buildings. Led by Pennsylvania State University, CBEI brings together fourteen organizations from universities, DOE national laboratories, and the private sector. For more information, see <http://cbei.psu.edu/>.
- <sup>17</sup> JCAP and CASL were initially awarded up to \$122 million over five years, while CMI and JCESR were initially awarded up to \$120 million over five years (subject to appropriations). In 2015, JCAP was renewed at up to \$75 million over five years, and CASL was renewed up to \$121.5 million over five years (pending congressional approval). In contrast, the first set of forty-six EFRCs, initiated in 2009, was funded at the level of \$2–\$5 million per year per center for five years. The second set of EFRCs, started in 2014, are funded at the level of \$2–\$4 million per year per center for four years, with an average award of \$3.125 million per year per center (32 EFRCs, \$100 million total program funding per year, subject to appropriations).
- <sup>18</sup> For example, there is currently no industrial solar fuels production. JCAP is therefore coordinating R&D across many research laboratories, including multiple EFRCs, to accelerate the pace of technology development and realize an entirely new direct solar fuels industry. By comparison, JCESR and CMI are striving to create new technologies that have the potential to transform large, established industries. They work closely with industrial partners as well as EFRCs (in the case of JCESR) to guide research efforts and ensure practical solutions that are competitive in marketplaces.
- <sup>19</sup> See textbox: Joint Center for Artificial Photosynthesis, in Chapter 7 ("Advancing Systems and Technologies to Produce Cleaner Fuels") and <http://www.solarfuelshub.org>.
- <sup>20</sup> For more on the Joint Center for Energy Storage Research, see text box in Chapter 8 ("Advancing Clean Transportation and Vehicle Systems and Technology") and <http://www.jcesr.org/>.
- <sup>21</sup> CASL research is also supported by the SC-ASCR program through expertise in HPC and dedicated allocation on Titan, one of two DOE-SC leadership-class computing user facilities (see Section 9.6.1). For more on CASL, see <http://www.casl.gov/>.
- <sup>22</sup> The criticality of selected rare earth metals as well as other elements used in clean energy technology and components was reviewed in the 2011 "Critical Materials Strategy" report; see <http://energy.gov/node/349057>. More on this topic is included in Chapter 6, "Innovating Clean Energy Technologies in Advanced Manufacturing."
- <sup>23</sup> For more on CMI, see <http://www.cmi.ameslab.gov>.
- <sup>24</sup> Hu, S.; Shaner, M. R.; Beardslee, J. A.; Lichterman, M.; Brunschwig, B. S.; Lewis, N. S. "Amorphous TiO<sub>2</sub> Coatings Stabilize Si, GaAs, and GaP Photoanodes for Efficient Water Oxidation." *Science* (344), 2014; pp. 1005–1009. Available at: <http://www.sciencemag.org/content/344/6187/1005.full?sid=4756f1a2-32db-40e6-ae85-dc503655658e>.
- <sup>25</sup> The three BRCs are the Bioenergy Science Center at ORNL, the Great Lakes Bioenergy Research Center at the University of Wisconsin-Madison, and the Joint Bioenergy Institute at LBNL. See Fundamental Research: Bioenergy Research Centers textbox in Chapter 7, "Advancing Systems and Technologies to Produce Cleaner Fuels."
- <sup>26</sup> The scientific rationale for the three BRCs and for fundamental genomic research for biofuels and bioproducts was established by the 2005 workshop Biomass to Biofuels, which is summarized in the report "Breaking the Biological Barriers to Cellulosic Ethanol: A Joint Research Agenda." DOE/SC-0095. Washington, DC: U.S. Department of Energy Office of Science. Available at: <http://www.genomicscience.energy.gov/biofuels/b2bworkshop.shtml>.
- <sup>27</sup> The three BRCs are funded at \$25M per center per year for up to five years (pending congressional approval). The three BRCs were renewed for a second five-year phase in 2012.
- <sup>28</sup> From 2008 to 2013, the three BRCs published nearly 1,350 papers in peer-reviewed journals.

- <sup>29</sup> From 2008 to 2013, the three BRCs disclosed 325 inventions and filed 176 patent applications of which 72 were licensed/optioned. A chart of cumulative totals by year from 2008 to 2013, the full list of BRC partners, and examples of recent technology transfer to the private sector are included in Bioenergy Research Centers, U.S. DOE, Office of Science, Office of Biological and Environmental Research, February 2014. Available at: <http://genomicscience.energy.gov/centers/BRCs2014HR.pdf>.
- <sup>30</sup> Ibid.
- <sup>31</sup> Transcriptomics is the study of the transcriptome, which is defined as the complete set of RNA transcripts produced by a genome, using high-throughput (or -omics) techniques. This definition is derived from <http://www.nature.com/subjects/transcriptomics>.
- <sup>32</sup> Foo, J. L.; Jensen, H. M.; Dahl, R. H.; George, K.; Keasling, J. D.; Lee, T. S.; Leong, S.; Mukhopadhyay, A. "Improving Microbial Biogasoline Production in *Escherichia coli* Using Tolerance Engineering" *MBio* (5:6), 2014; pp. e01932-e01914. Available at: <http://mbio.asm.org/content/5/6/e01932-14>.
- <sup>33</sup> DOE-designated user facilities are also critically important for basic research in the biological and medical sciences and for national security.
- <sup>34</sup> An interactive map of DOE-SC scientific user facility statistics for FY 2014, as well as the source data, is available at <http://science.energy.gov/user-facilities/user-statistics/>. This interactive map provides information on individual user projects at each facility, including institutional affiliation, number of users from that institution, and congressional district of the institution. More information on scientific user facility usage is provided in Supplemental Information (section 9C).
- <sup>35</sup> Detailed information on the types of agreements available to potential users of DOE designated user facilities is available at <http://energy.gov/gc/access-high-technology-user-facilities-doe-national-laboratories>. All DOE-SC scientific user facilities are open access to interested users as defined in a 2012 DOE-SC memorandum available at [http://science.energy.gov/~media/\\_/pdf/user-facilities/memoranda/Office\\_of\\_Science\\_User\\_Facility\\_Definition\\_Memo.pdf](http://science.energy.gov/~media/_/pdf/user-facilities/memoranda/Office_of_Science_User_Facility_Definition_Memo.pdf). Additional information about DOE-SC scientific user facility policies is available at <http://science.energy.gov/user-facilities/frequently-asked-questions/>.
- <sup>36</sup> For examples of the diversity of science and technology research at the multipurpose user facilities, see the APS Science 2014 brochure at [https://www1.aps.anl.gov/files/download/APS-Science/APS\\_Science\\_2014.pdf](https://www1.aps.anl.gov/files/download/APS-Science/APS_Science_2014.pdf); the ORNL Neutron Sciences division Strategic Plan 2014 at <https://neutrons.ornl.gov/sites/default/files/NScD-Strategic-Plan-2014.pdf>; and the five-year strategic plans for The Molecular Foundry at <http://foundry.lbl.gov/assets/docs/TMF-Strategic-Plan.pdf> and the Center for Functional Nanomaterials at <https://www.bnl.gov/cfn/strategicplan/mission.php>. For more on the research diversity at EMSL, see Section 9.5.2 and references therein. For more on the research diversity of the high-performance computing facilities supported by the DOE-SC, see Section 9.6.1 and references therein.
- <sup>37</sup> For example, the five X-ray light sources stewarded by the SC-BES program are an invaluable tool for the biological sciences, providing unique capabilities for characterizing biological molecules from single protein crystals to imaging of whole cells. At LCLS, while about 50% of the nearly 600 users are from the physics community, more than a quarter of users are from the biological and chemical sciences.
- <sup>38</sup> The Energy Systems Integration Facility is maintained by DOE-EERE and the National Renewable Energy Laboratory. More information is available at <http://www.nrel.gov/esif/>.
- <sup>39</sup> For more information on the Advanced Test Reactor and other capabilities in the NSUF, see <http://www4vip.inl.gov/research/advanced-test-reactor-research/>.
- <sup>40</sup> The Carbon Fiber Technology Facility houses a highly instrumented carbon fiber production line for demonstrating scalability to near production-scale. More information is available at <http://www.ornl.gov/user-facilities/cftf>.
- <sup>41</sup> Additional information on MDF capabilities, research projects, and partnering organizations is available at <http://web.ornl.gov/sci/manufacturing/>.
- <sup>42</sup> A complete list of the experimental capabilities available at the Building Envelope, Building Technology, and System/Building Integration Centers of Excellence is described in the "Experimental Capabilities & Apparatus Directory," available at [http://web.ornl.gov/sci/buildings/docs/buildings\\_catalog.pdf](http://web.ornl.gov/sci/buildings/docs/buildings_catalog.pdf).
- <sup>43</sup> Experimental capabilities include dynamometers (for engines, motors, and vehicles), analytical chemistry and catalysis laboratories, in situ chemical speciation for catalysts and engines (methods invented at ORNL), power electronic and electric motor device testing, battery manufacturing, and the Vehicle Systems Laboratory, containing a full powertrain research cell suitable for studying class 8 truck systems. A complete list of capabilities is available at <http://web.ornl.gov/sci/transportation/facilities/ntrc/index.shtml>.
- <sup>44</sup> The Sustainable Transportation Program's strategy includes accelerating electric vehicle penetration, increasing all vehicle efficiency through lighter materials, hybrid drives and advanced combustion technology, adoption of renewable biofuels and natural gas, and decision science. More is available in the Sustainable Transportation Program brochure at <http://web.ornl.gov/sci/transportation/docs/brochures/STP-Brochure.pdf>.
- <sup>45</sup> More information is available at <https://www.inl.gov/wnu/>.
- <sup>46</sup> Acronyms used in Table 9.1 are as follows: (1) Department of Energy Office of Energy Efficiency and Renewable Energy (DOE-EERE), (2) Office of Nuclear Energy (DOE-NE), (3) Office of Basic Energy Sciences (SC-BES), (4) Office of Biological and Environmental Research (SC-BER), (5) Office of Advanced Scientific Computing Research (SC-ASCR), (6) Office of High Energy Physics (SC-HEP), (7) Office of Nuclear Physics (SC-NP), and (8) Office of Fusion Energy Science (SC-FES).
- <sup>47</sup> In the FY 2016 budget request, the DOE-SC has proposed that this will be the final year of funding support for the Alcatraz C-Mod facility.



- <sup>48</sup> Acronyms and shortened forms used in Table 9.2 are as follows: (1) Ames Laboratory (Ames), (2) Argonne National Laboratory (ANL), (3) Brookhaven National Laboratory (BNL), (4) Fermi National Accelerator Laboratory (FNAL), (5) Idaho National Laboratory (INL), (6) Lawrence Berkeley National Laboratory (LBNL), (7) National Energy Technology Laboratory (NETL), (8) National Renewable Energy Laboratory (NREL), (9) Oak Ridge National Laboratory (ORNL), (10) Pacific Northwest National Laboratory (PNNL), and (11) Sandia National Laboratories (SNL).
- <sup>49</sup> Examples include the Battery Test Facilities at ANL, the Facility for Low Energy Experiments in Buildings (FLEXLAB) and the Advanced Biofuels Processing Demonstration Unit (ABPDU) at LBNL, and the National Solar Thermal Test Facility at SNL.
- <sup>50</sup> The Combustion Research Facility at SNL is a joint DOE-SC and DOE-EERE facility dedicated to combustion science and technology. Users have access to capabilities ranging from flame analysis to laser-based in cylinder process characterization. The National Transportation Research Center at ORNL supports the private sector and government agencies in development of advanced vehicle technologies. Available capabilities range from analytical laboratories for catalysis and combustion to the vehicle systems laboratory, a full powertrain research cell large enough for class 8 truck systems.
- <sup>51</sup> Examples include the materials preparation center at Ames and the high throughput facility for materials chemistry development at ANL.
- <sup>52</sup> A complete, searchable list of DOE designated user facilities and shared R&D facilities, including Web links, is available at <http://energy.gov/technologytransitions/technology-transitions-facilities-database>.
- <sup>53</sup> Work at laboratory R&D facilities will typically be supported by technology partnership agreements (Collaborative Research and Development Agreements [CRADA] or Strategic Partnership Projects [SPP; formerly known as Work for Others]). The facilities at the National Energy Technology Laboratory are made available to researchers through an alternative contractual mechanism. More information on this and other access agreements can be found at <http://energy.gov/technologytransitions/technology-transitions-facilities-database>.
- <sup>54</sup> Savee, J. D.; Papajak, E.; Rotavera, B.; Huang, H.; Eskola, A. J.; Welz, O.; Sheps, L.; Taatjes, C. A.; Zádor, J.; Osborn, D. L. "Direct Observation and Kinetics of a Hydroperoxyalkyl Radical (QOOH)." *Science* (347:6222), 2015; pp. 643-646. Available at: <http://www.sciencemag.org/content/347/6222/643.full?sid=0f7b894c-d4ae-4026-8758-6bfaf9b2e7ce>.
- <sup>55</sup> "From Quanta to the Continuum: Opportunities for Mesoscale Science." A report from the Basic Energy Sciences Advisory Committee, September 2012. Available at: [http://science.energy.gov/~media/bes/pdf/reports/files/OFMS\\_rpt.pdf](http://science.energy.gov/~media/bes/pdf/reports/files/OFMS_rpt.pdf).
- <sup>56</sup> Ibid.
- <sup>57</sup> For more on the properties of synchrotron radiation and the types of experiments it enables, see "Experimental Techniques at Light-source Beamlines." Available at: [http://science.energy.gov/~media/bes/pdf/Synchrotron\\_Techniques.pdf](http://science.energy.gov/~media/bes/pdf/Synchrotron_Techniques.pdf).
- <sup>58</sup> More information on the technical specifications of each X-ray light source, as well as complete listings of experiments available, can be found at the facility Web sites.
- <sup>59</sup> Recent examples from the national laboratories are as follows: (a) Liu, H.; Strobridge, F. C.; Borkiewicz, O. J.; Wiaderek, K. M.; Chapman, K. W.; Chupas, P. J.; Grey, C. P. "Capturing Metastable Structures During High-rate Cycling of LiFePO<sub>4</sub> Nanoparticle Electrodes." *Science* (344:6191), 2014; pp. 1252817-1-7. Available at: <http://www.sciencemag.org/content/344/6191/1252817> (APS). (b) Liu, X. S.; Wang, D. D.; Liu, G.; Srinivasan, V.; Liu, Z.; Hussain, Z.; Yang, W. L. "Distinct Charge Dynamics in Battery Electrodes Revealed by In Situ and Operando Soft X-ray Spectroscopy." *Nature Communications* (4), 2013. Available at: <http://www.nature.com/ncomms/2013/131008/ncomms3568/full/ncomms3568.html> (ALS). (c) Yu, Y.-S.; Kim, C.; Liu, Y.; Van der Ven, A.; Meng, Y. S.; Kostecki, R.; Cabana, J. "Nonequilibrium Pathways During Electrochemical Phase Transformations in Single Crystals Revealed by Dynamic Chemical Imaging at Nanoscale Resolution." *Advanced Energy Materials* (5:7), 2015. Available at: <http://onlinelibrary.wiley.com/doi/10.1002/aenm.201402040/abstract> (SSRL).
- <sup>60</sup> Wang, Y.; Liu, X.; Im, K.-S.; Lee, W.-K.; Wang, J.; Fezzaa, K.; Hung, D. L. S.; Winkelman, J. R. "Ultrafast X-ray Study of Dense-liquid-jet Flow Dynamics Using Structure-tracking Velocimetry." *Nature Physics* (4), 2008; pp. 305-309. Available at: <http://www.nature.com/nphys/journal/v4/n4/abs/nphys840.html>.
- <sup>61</sup> The Solar Shingle is a commercial product developed by Dow Chemical Company that integrates a series of small form factor photovoltaic devices directly into roofing material. In situ X-ray diffraction and scanning techniques were used at the APS to develop a semiconductor fabrication process that would optimize the solar photovoltaic properties of the CIGS active material. For more on the solar shingle developed by Dow Chemical Company, see Supplemental Information (section 9D).
- <sup>62</sup> The prizes include the 2012 prize for studies of the G-protein coupled receptors (Advanced Photon Source); the 2009 prize for the structure of the ribosome (National Synchrotron Light Source); the 2008 prize for green fluorescent protein (National Synchrotron Light Source); and the 2006 prize for DNA transcription (Stanford Synchrotron Radiation Light Source). A fifth prize in 2002 was awarded for the study of ion channels in cell membranes (National Synchrotron Light Source).
- <sup>63</sup> In addition to the five X-ray light sources currently operating in the United States, there are currently eight operating storage rings and free electron lasers in Europe and Asia. Next generation storage rings are in development in Brazil, France, Germany, Japan, and Sweden, and hard X-ray FELs (similar to LCLS) are under construction in Germany, Korea, and Switzerland. More information on the international light sources, including comparative technical information, is available in the 2013 BESAC report, "Future X-ray Light Sources." Available at: <http://science.energy.gov/bes/besac/reports/>.
- <sup>64</sup> The scientific basis for the upgrades to LCLS and APS (LCLS-II and APS-U, respectively) are presented in the 2013 BESAC report, "Future X-ray Light Sources." Available at: <http://science.energy.gov/bes/besac/reports/>.
- <sup>65</sup> When fully built out, NSLS-II will accommodate 60–70 beamlines. Descriptions of the beamlines available and a timeline for development of new beamlines (with links to associated projects and beamline descriptions) are available at <http://www.bnl.gov/ps/nsls2/beamlines/timeline.php>.

- <sup>66</sup> Öström, H.; Oberg, H.; Xin, H.; LaRue, J.; Beye, M.; Dell'Angela, M.; Gladh, J.; Ng, M. L.; Sellberg, J. A.; Kaya, S.; Mercurio, G.; Nordlund, D.; Hantsschmann, M.; Hieke, F.; Kühn, D.; Schlotter, W. F.; Dakovski, G. L.; Turner, J. J.; Minitti, M. P.; Mitra, A.; Moeller, S. P.; Föhlisch, A.; Wolf, M.; Wurth, W.; Persson, M.; Nørskov, J. K.; Abild-Pedersen, F.; Ogasawara, H.; Pettersson, L. G. M.; Nilsson A. "Probing the Transition State Region in Catalytic CO Oxidation on Ru." *Science* (347:6225), 2015; pp. 978-982. Available at: <http://www.sciencemag.org/content/347/6225/978.full?sid=a9fb4930-933b-4778-b609-1cbd9c367567>.
- <sup>67</sup> The SNS and HFIR user facilities hosted approximately 1,350 unique users in FY 2014.
- <sup>68</sup> Spallation is a process by which neutrons and other particles are ejected from a heavy metal target owing to impacts from a high-energy particle beam. At the Spallation Neutron Source at Oak Ridge National Laboratory, neutrons are produced by the spallation process from a liquid mercury target in a beam of protons from a linear accelerator operating in a 60 Hz pulse mode at 1 GeV and at a power level of approximately 1.4 MW.
- <sup>69</sup> The High Flux Isotope Reactor produces a continuous beam of neutrons from a light-water moderated and cooled nuclear reactor operating at 85 MW. The HFIR provides neutrons to a full suite of instruments, including diffraction, small angle scattering, imaging, and inelastic scattering. A complete list of experiments with links to descriptions and scientific applications is available at <https://neutrons.ornl.gov/hfir>.
- <sup>70</sup> Each scattering instrument is tailored for specific types of scattering experiments, including diffraction, reflectometry, inelastic scattering, and small angle scattering. A list of SNS experiments and links to descriptions, including scientific applications, is available at <https://neutrons.ornl.gov/sns>.
- <sup>71</sup> Neutron scattering has been used to study stresses in jet engine turbines, bridge support cables, and additive manufacturing processes. These and other examples are summarized at <https://neutrons.ornl.gov/> and in the included scientific references.
- <sup>72</sup> Because the energy of the moderated neutrons is in the milli-electron volt range, comparable to that of quantized elementary atomic and magnetic excitations (phonons and magnons), the interaction of the neutron in passing through the sample can excite or de-excite these elementary excitations, thereby driving a corresponding shift in the energy of the scattered neutrons. This energy shift can be measured by the spectrometer and provides information about the excitation.
- <sup>73</sup> The National Institute of Standards and Technology Center for Neutron Research provides cold and thermal neutrons to a broad suite of instruments for all qualified applicants from universities, the private sector, and other government agencies. NCNR is a user facility operated by the U.S. Department of Commerce. More can be found at <https://www.ncnr.nist.gov/>.
- <sup>74</sup> In addition to the two domestic sources, there are multiple neutron sources operating or in development internationally. For example, the Japanese J-Parc facility is a one megawatt class pulse neutron facility offering a comprehensive suite of instruments via a user program. The Institut Laue-Langevin (ILL) in Grenoble, France, is the world's highest flux continuous wave neutron source. When complete, the European Spallation Source in Lund, Sweden will be the world's most advanced neutron source, operating at five megawatts and providing the largest number of instruments at the highest neutron flux. Operation is expected to begin in 2019.
- <sup>75</sup> The scientific drivers and user demand for these capabilities were delineated by a series of user-led workshops in 2014. The proposed technical details and applications of the second target station are described in the 2013 BESAC report "Basic Energy Sciences Facilities Prioritization." Available at: [http://science.energy.gov/~media/bes/besac/pdf/Reports/BESAC\\_Facilities\\_Prioritization\\_Report\\_2013.pdf](http://science.energy.gov/~media/bes/besac/pdf/Reports/BESAC_Facilities_Prioritization_Report_2013.pdf).
- <sup>76</sup> Nanoscience Research for Energy Needs, BES-cosponsored NNI Workshop, March 16–18, 2004.
- <sup>77</sup> The NSRC Program is a major component of the DOE-SC contribution to the NNI. Additional support for nanoscale science and engineering research within DOE is provided by the offices of DOE-EERE, DOE-FE, and DOE-NE. More on the DOE involvement with the NNI is available at [www.science.energy.gov/bes/research/national-nanotechnology-initiative](http://www.science.energy.gov/bes/research/national-nanotechnology-initiative). NNI involves 20 departments and agencies that collaborate toward "a future in which the ability to understand and control matter at the nanoscale leads to a revolution in technology and industry that benefits society." More on the National Nanotechnology Initiative is available at <http://www.nano.gov>.
- <sup>78</sup> Descriptions of each NSRC, as well as other colocated user facilities, are provided at <http://science.energy.gov/bes/suf/user-facilities/nanoscale-science-research-centers/>.
- <sup>79</sup> A more comprehensive list of the specialties available at the five NSRCs across the categories of synthesis, characterization, and theory/modeling/simulation can be found at the NSRC Portal hosted by SNL. Available at: <https://nsrcportal.sandia.gov>.
- <sup>80</sup> Industrial activities at the NSRCs range from basic to applied research, conducted by both small start-up and large, established corporations. Many examples of recent industrial research projects at the NSRCs are described at <https://nsrcportal.sandia.gov/home/industrial>.
- <sup>81</sup> For more on the impact of nanotechnology for energy applications, see the brochure "Nanotechnology and Energy: Powerful Things from a Tiny World." Available at: <http://www.nano.gov/node/734>. For more on the benefits and applications of nanoscience, see <http://www.nano.gov/you/nanotechnology-benefits>.
- <sup>82</sup> (a) Llordes, A.; Garcia, G.; Gazquez, J.; Milliron, D. J. "Tunable near-infrared and visible light transmittance in nanocrystal-in-glass composites." *Nature* (500), 2013; pp. 323-326. Available at: <http://www.nature.com/nature/journal/v500/n7462/full/nature12398.html>. (b) Runnerstrom, E. L.; Llordes, A.; Lounis, S. D.; Milliron, D. J. "Nanostructured Electrochromic Smart Windows: Traditional Materials and NIR-selective Plasmonic Nanocrystals." *Chemical Communications* (50:73), 2014; pp. 10555-10572. Available at: <http://pubs.rsc.org/en/content/articlelanding/2014/cc/c4cc03109a>.
- <sup>83</sup> Demortière, A.; Snezhko, A.; Sapozhnikov, M. V.; Becker, N.; Proslie, T.; Aranson, I. S. "Self-Assembled Tunable Networks of Sticky Colloidal Particles." *Nature Communications* (5), 2014. Available at: <http://www.nature.com/ncomms/2014/140121/ncomms4117/full/ncomms4117.html>.
- <sup>84</sup> The DOE Systems Biology Knowledgebase (KBase, <http://kbase.us>) is a large-scale bioinformatics system supporting the BER genomic science user community. KBase allows users to upload, analyze, and model their data as well as share workflows and conclusions with the broader community. The data collected through routine operations and scientific field experiments at ARM are stored at the ARM data archive and made publically available to registered users at <http://www.archive.arm.gov>.



- <sup>85</sup> JGI was originally established in 1997 to support the DOE role in the Human Genome Project. JGI united the expertise and resources in DNA sequencing, informatics, and technology development that existed in the three DOE genome centers at LBNL, LANL, and LLNL. LBNL, as lead laboratory, consolidated activities at the current location in Walnut Creek, CA. This enabled a dramatic increase in the scale of JGI activities.
- <sup>86</sup> JGI data is freely available to registered users at the DOE JGI Genome Portal, <http://jgi.doe.gov/data-and-tools>. Additionally, users have access to more specialized data and analysis resources, including the Integrated Microbial Genomes, Integrated Microbial Genome/Metagenomes, and the Phytosome, Mycosm, and Genomes On-line Database.
- <sup>87</sup> More on the BRCs is available in Section 9.2.3 of this chapter and in Chapter 7, “Advancing Systems and Technologies to Produce Cleaner Fuels.”
- <sup>88</sup> Biofuels currently provide approximately 5% of total U.S. energy supply, primarily in the transportation sector. For more information see Chapter 7, “Advancing Systems and Technologies to Produce Cleaner Fuels.”
- <sup>89</sup> The report “Biomass as Feedstock for a Bioenergy and Bioproducts Industry: The Technical Feasibility of a Billion-Ton Annual Supply” (the Billion-Ton Study or 2005 BTS) was conducted in 2005 to determine the potential domestic capacity of biomass for energy. A follow-up study, “U.S. Billion Ton Update: Biomass Supply for Bioenergy and Bioproducts Industry” (or 2011 BT2), was completed in 2011. Both reports are available at <https://bioenergykdf.net/content/billiontonupdate>.
- <sup>90</sup> The current 10-year JGI strategic vision (<http://jgi.doe.gov/wp-content/uploads/2013/05/10-Year-JGI-Strategic-Vision.pdf>) was assembled with extensive input from DOE, JGI users, and advisory panels. The plan describes key scientific goals that need to be addressed and outlines a portfolio of new strategic capabilities to be developed over the next decade to enable users of the facility to achieve these goals.
- <sup>91</sup> Available at: <http://www.jgi.doe.gov/programs/GEBA/>.
- <sup>92</sup> Rinke, C.; Schwientek, P.; Sczyrba, A.; Ivanova, N. N.; Anderson, I. J.; Cheng, J-F; Darling, A.; Malfatti, S.; Swan, B. K.; Gies, E. A.; Dodsworth, J. A.; Hedlund, B. P.; Tsiamis, G.; Sievert, S. M.; Liu, W-T; Eisen, J. A.; Hallam, S. J.; Kyrpides, N. C.; Stepanauskas, R.; Rubin, E. M.; Hugenholtz, P.; Woyke T. “Insights into the Phylogeny and Coding Potential of Microbial Dark Matter.” *Nature* (499), 2013; pp. 431–437. Available at: <http://www.nature.com/nature/journal/v499/n7459/full/nature12352.html>.
- <sup>93</sup> The scope of EMSL as originally defined by former PNNL director William Wiley was, in part, a response to the 1985 National Academy of Sciences report “Opportunities in Chemistry.” Available at: <http://www.nap.edu/catalog/606/opportunities-in-chemistry>.
- <sup>94</sup> A description of the major capabilities provided to users of the EMSL is available at <https://www.emsl.pnl.gov/emslweb/scientific-capabilities>.
- <sup>95</sup> The Biosystems Dynamics and Design program is focused on regulation of spatial and temporal parameters of metabolic processes in plants, fungi, and microbes. The overarching goal is to understand how biological systems respond to and modify their environment and ultimately to modify and manipulate these systems for novel bioenergy and biorenewable technologies. For specific capabilities and recent science highlights from the Biosystems Dynamics and Design program, see <https://www.emsl.pnl.gov/emslweb/science/biosystem>.
- <sup>96</sup> The Terrestrial and Subsurface Ecosystems program couples experimentally derived mechanistic understanding of biogeochemical and microbial processes in the environment with pore-scale hydrological models to improve strategies for sustainable contaminant remediation, attenuation, and biogeochemical cycling. For specific capabilities and recent science highlights from the Terrestrial and Subsurface Ecosystems program, see <http://www.emsl.pnl.gov/emslweb/science/terrestrial>.
- <sup>97</sup> The Energy Materials and Systems program focuses on facilitating the development and dissemination of molecular-level understanding and predictive modeling of interfaces to enable the design and development of efficient and environmentally benign energy storage and conversion systems. For specific capabilities and recent science highlights, see <http://www.emsl.pnl.gov/emslweb/science/energy>.
- <sup>98</sup> The tesla is the international system of units’ measure of magnetic flux density. The 21 Tesla magnet in this instrument enables users to gain unprecedented mass resolution and accuracy, with mass measurements possible to five to six decimal points and accuracy to one part-per-million. The high mass resolution provided allows definitive identification of all molecular species in a complex system, while the high mass accuracy will help remove ambiguity in identifying molecular species. The scientific basis for development of the 21 Tesla high-resolution mass accuracy capability was delineated by a workshop held in 2008. Available at: <http://www.emsl.pnl.gov/emslweb/next-generation-mass-spectrometry>. More information on this system is available at <http://www.emsl.pnl.gov/emslweb/21t-high-resolution-mass-accuracy-capability>.
- <sup>99</sup> Knopf, D. A.; Alpert, P. A.; Wang, B.; O’Brien, R. E.; Kelly, S. T.; Laskin, A.; Gilles, M. K.; Moffet, R. C. “Microspectroscopic Imaging and Characterization of Individually Identified Ice Nucleating Particles from a Case Field Study.” *Journal of Geophysical Research—Atmospheres* (119:17), 2014; pp. 10,365–10,381. Available at: <http://onlinelibrary.wiley.com/doi/10.1002/2014JD021866/full>.
- <sup>100</sup> ARM is managed and operated by nine DOE national laboratories. Each laboratory has specific roles and responsibilities in the partnership. For a list of the partnering labs and their responsibilities in the ARM program, see <http://www.arm.gov/about/organization/labs>.
- <sup>101</sup> Since 2005, ARM mobile sites have been deployed in North and South America, Europe, Asia, and Africa.
- <sup>102</sup> The ARM aerial facility provides airborne measurements to address ARM science questions by using either external aircraft or the DOE-supported Gulfstream-1 and Cessna 206 aircraft. The aerial facility includes multiple aircraft sensors for in situ measurements of atmospheric, aerosol, and cloud properties. Available at: <http://www.arm.gov/sites/aaf>.
- <sup>103</sup> Remote sensing instruments available at ARM sites include vertically pointing and scanning radars, lidars, and multiple radiometers. For a complete list of measurement capabilities at each ARM site, see <http://www.arm.gov/instruments>.
- <sup>104</sup> These observations have led to improvements in temperature and humidity profiles as well as cloud amount in the middle and upper troposphere. For this and other applications of ARM data, see “Contributions of the Atmospheric Radiation Measurement (ARM) Program and the ARM Climate Research Facility to the U.S. Climate Change Science Program.” September 2008. Available at: <http://www.arm.gov/publications/programdocs/doe-sc-arm-0803.pdf?id=61>.



- <sup>105</sup> The ARM data archive is located at <http://www.archive.arm.gov/armlogin/login.jsp>.
- <sup>106</sup> The 983 users of ARM in FY 2014 represent universities, the private sector, DOE national laboratories, other federal agencies, and international institutions.
- <sup>107</sup> Feldman, D. R.; Collins, W. D.; Gero, P. J.; Torn, M. S.; Mlawer, E. J.; Shippert T. R. "Observational Determination of Surface Radiative Forcing by CO<sub>2</sub> from 2000 to 2010." *Nature* (519), 2015; pp. 339-343.
- <sup>108</sup> <http://www.nap.edu/catalog/18805/climate-intervention-carbon-dioxide-removal-and-reliable-sequestration>.
- <sup>109</sup> <http://www.nap.edu/catalog/18988/climate-intervention-reflecting-sunlight-to-cool-earth>.
- <sup>110</sup> The Materials Project at LBNL (see <http://www.materialsproject.org>) combines supercomputing at NERSC (see Section 9.6.1) with novel electronic structure calculation methods to calculate properties of known and predicted materials as well as provide tools for designing novel materials with tailored properties.
- <sup>111</sup> CASL, a DOE Energy Innovation Hub, has developed modeling and simulation tools for nuclear reactor behavior at unprecedented fidelity. These tools have been optimized to leverage the computing power of Titan, a DOE leadership-class computer at ORNL (see Section 9.6.1).
- <sup>112</sup> A team from SNL utilized Titan to perform direct numerical simulation to simulate a jet flame burning dimethyl ether. The resulting improvement to models based on these results will be used in engineering-scale computational fluid dynamics simulations that are used to optimize combustion devices burning a variety of fuels with the ultimate goal of shortening the design lifetime for new technology. For more information see "The Complexities of Combustion" at <https://www.olcf.ornl.gov/2014/11/11/the-complexities-of-combustion/> and references therein.
- <sup>113</sup> In collaboration with ORNL, BMI Corporation engineers leverage the computing capabilities of Titan to study air flow around class 8 long-haul trucks and optimize add-on parts that could dramatically reduce drag. The resulting UnderTray system, marketed by SmartTruck Systems, can improve fuel efficiency by more than 10%. Leveraging DOE high-performance computers, BMI Corporation was able to reduce the time from concept to manufacture-ready design from three years to 18 months.
- <sup>114</sup> GE Global Research have used Titan at ORNL to model the formation of ice on various ice-phobic surfaces in an effort to reduce the energy cost of maintaining ice-free turbine blades and promote development of wind resources in colder climates. For more information, see "Titan Propels GE Wind Turbine Research into New Territory" at <https://www.olcf.ornl.gov/2013/10/25/titan-propels-ge-wind-turbine-research-into-new-territory/> and references therein.
- <sup>115</sup> Relevant workshops and associated reports are tabulated in Supplemental Information (Chapter 1). A list with brief descriptions of the workshop scope is available at <http://science.energy.gov/ascr/news-and-resources/workshops-and-conferences/> (from 2014 on) and <http://science.energy.gov/ascr/news-and-resources/workshops-and-conferences/workshops-conferences-archive/> (from 2006 to 2013).
- <sup>116</sup> See Section 9.6.1 for more information on the INCITE and ALCC funding programs.
- <sup>117</sup> Recent industrial projects leveraging Office of Science computing resources are tabulated in Supplemental Information (section 9B).
- <sup>118</sup> For more on CASL see textbox, "Westinghouse-CASL Team Simulates High-Fidelity Next-Generation Light Water Reactors" in Section 9.6.3.
- <sup>119</sup> The Advanced Computing Tech Team (ACTT) is comprised of representation from the DOE energy technology offices, DOE-SC, NNSA, and DOE national laboratories. Its goal is to deliver technologies that will be used to create new scientific insights into complex physical systems. The ACTT serves as a mechanism by which DOE programs working in the HPC space can communicate their efforts and identify new, mutually beneficial opportunities. These efforts have led to multiple workshops engaging with external stakeholders. More on the ACTT can be found at <http://www.energy.gov/advanced-computing-tech-team>.
- <sup>120</sup> Supercomputer performance is typically described in terms of the number of petaflops (pflops), or  $1 \times 10^{15}$  floating-point operations per second (FLOPS). The threshold for exascale computing is defined as 1,000 pflops. For comparison, current DOE leadership-class computers are between 8 and 18 pflops.
- <sup>121</sup> For comparison, seven of the top fifteen supercomputers are located in Europe and Asia.
- <sup>122</sup> FLOPS or flops (FLoating-point Operations Per Second) is a measure of a computer's performance.
- <sup>123</sup> Examples of leadership-class computing research from FY 2015 are tabulated in Supplemental Information (section 9B).
- <sup>124</sup> Bayerl, D.; Kioupakis, E. "Visible-Wavelength Polarized-Light Emission with Small-Diameter InN Nanowires." *Nano Letters* (14:7), 2014; pp. 3709-3714. Available at: <http://pubs.acs.org/doi/pdf/10.1021/nl404414r>.
- <sup>125</sup> The availability of these machines is based on the DOE High-end Computing Act of 2004.
- <sup>126</sup> In 2015, the ALCC provided 2.9 billion hours of computational time to 43 research projects that had already received federal, state, or corporate funding. The total requested hours were 10.7 billion hours, indicating these facilities are oversubscribed by a factor of 3.7.
- <sup>127</sup> In FY 2015, INCITE has allocated 3,670 million core hours to 37 projects. Twelve projects, accounting for 1,322 core hours, having relevance to the technologies surveyed in the QTR, are tabulated in Supplemental Information (section 9B). Note that INCITE projects are not required to be immediate DOE research priorities.
- <sup>128</sup> Constable, G.; Somerville, B. *A Century of Innovation: Twenty Engineering Achievements that Transformed our Lives*. National Academies Press, Washington, DC, 2003.
- <sup>129</sup> Ela, E.; Milligan, M.; Kirby, B. "Operating Reserves and Variable Generation." NREL/TP-5500-51978, August 2011. Available at: <http://www.nrel.gov/docs/fy11osti/51978.pdf>.



<sup>130</sup> (a) Petra, C. G.; Schenk, O.; Anitescu, M. “Real-time Stochastic Optimization of Complex Energy Systems on High Performance Computers.” *Computing in Science and Engineering* (16:5), 2014; pp. 32-42. Available at: <http://ieeexplore.ieee.org/xpl/articleDetails.jsp?arnumber=6809706>. (b) Constantinescu, E.; Zavala, V.; Rocklin, M.; Lee, S.; Anitescu, M. “A Computational Framework for Uncertainty Quantification and Stochastic Optimization in Unit Commitment with Wind Power Generation.” *IEEE Transactions on Power Systems* (26:1), 2011; pp. 431-441. Available at: <http://ieeexplore.ieee.org/xpl/articleDetails.jsp?arnumber=5467169>. (c) Lubin, M.; Petra, C. G.; Anitescu, M.; Zavala, V. “Scalable Stochastic Optimization of Complex Energy Systems.” SC11 Proceedings of 2011 International Conference for High Performance Computing, Networking, Storage and Analysis, November 12–18, 2011, Seattle, Washington. ANL/MCS-P1858-0311. Argonne, IL: Argonne National Laboratory, 2011. Available at: <http://www.mcs.anl.gov/publication/scalable-stochastic-optimization-complex-energy-systems>.

<sup>131</sup> For more information, see <http://www.mcs.anl.gov/MACS/>.

<sup>132</sup> “National Power Grid Simulation Capability: Needs and Issues.” U.S. Department of Homeland Security, Science and Technology Directorate, 2008.

<sup>133</sup> Complete lists of private sector allocations for FY 2015 at OLCF, ALCF, and NERSC are tabulated in Supplemental Information (section 9B).

<sup>134</sup> Grosvenor, A. D.; Rixon, G. S.; Sailer, L. M.; Matheson, M. A.; Gutzwiller, D. P.; Demeulenaere, A.; Contier, M.; Strazisar, A. J. “High Resolution RANS NLH Study of Stage 67 Tip Injection Physics.” ASME Turbo Expo 2014: Turbine Technical Conference and Exposition; June 16–20, 2014, Düsseldorf, Germany. Paper No. GT2014-27219, p. V02BT39A045.

<sup>135</sup> A table of the high-performance computers sited at DOE national laboratories that rank in the top 150 fastest computers is provided in Supplemental Information (section 9B).

<sup>136</sup> “Case Study: Plexos and Power Modeling Software.” High Performance Computing Innovation Center. Accessed June 12, 2015: <http://hpcinnovationcenter.llnl.gov/case-study-plexos-and-power-modeling-software>.

<sup>137</sup> “Case Study: Navistar and Semi-Truck Fuel Efficiency.” High Performance Computing Innovation Center. Accessed June 12, 2015: <http://hpcinnovationcenter.llnl.gov/case-study-navistar-and-semi-truck-fuel-efficiency>.

<sup>138</sup> The High Performance Computing Center housed in the Energy Systems Integration Facility at NREL hosts Peregrine, a 1.2 pflop (peak performance) computer dedicated to renewable energy and energy efficiency research. More information is available at <http://hpc.nrel.gov/about>.

<sup>139</sup> The High Performance Computer for Energy and the Environment (HPCEE) is a 0.503 pflop computer housed in the Simulation-based Engineering User Center at the National Energy Technology Laboratory (NETL). More information is available at <https://hpc.netl.doe.gov/>.

<sup>140</sup> <http://energy.gov/articles/department-energy-awards-425-million-next-generation-supercomputing-technologies>.

<sup>141</sup> A complete map of ESNET is available at <https://www.es.net/engineering-services/the-network/>.

<sup>142</sup> Examples include Trilinos (SNL), PETSc (ANL), and Chombo (LBNL).

<sup>143</sup> For more on Energy Innovation Hubs, see Section 9.2.2.

<sup>144</sup> Franceschini, F.; Oelrich, Jr., B.; Gehin, J. “Simulation of AP1000 First Core with VERA.” *Nuclear Engineering International*, 2014; pp. 33-35. Available at: <http://www.neimagazine.com/features/featuresimulation-of-ap1000-first-core-with-vera-4295660/>.

<sup>145</sup> Of the more than 300 alumni of the program, 28% are in government, 38% in education, and 34% in the private sector.

<sup>146</sup> The benefits of exascale and the scope of the challenge in reaching this level of computing were laid out in the 2010 ASCAC report “The Opportunities and Challenges of Exascale Computing.” Available at: [http://science.energy.gov/~media/ascr/ascac/pdf/reports/Exascale\\_subcommittee\\_report.pdf](http://science.energy.gov/~media/ascr/ascac/pdf/reports/Exascale_subcommittee_report.pdf).

<sup>147</sup> *A National Strategy for Advancing Climate Modeling*. The National Academies, 2012.

<sup>148</sup> *CFD Vision 2030 Study: A Path to Revolutionary Computational Aerosciences*. NASA, 2014.

<sup>149</sup> The three codesign centers are the Exascale Co-design Center for Materials in Extreme Environments (ExMatEx), the Center for Exascale Simulation of Advanced Reactors (CESAR), and the Center for Exascale Simulation of Combustion in Turbulence (ExaCT). Each center is a collaboration among DOE national laboratories, academic institutions, and, in the case of CESAR, private sector partners. The scope of work at each center is designed to have broad impacts across the energy technology landscape. More information on codesign and the three centers is available at <http://science.energy.gov/ascr/research/scidac/co-design/>.

<sup>150</sup> Proposals for future colliders, such as the international linear collider (ILC) and compact linear collider (CLIC), will collide electrons and positrons at hundreds of GeV in separate linear accelerators. The ILC would be based on SRF technology. The CLIC accelerators utilize a drive beam acceleration approach that enables very high accelerating gradients (up to 100 MV/m). More information is available at <http://www.linearcollider.org/>.

<sup>151</sup> The proposed high luminosity upgrade to the Large Hadron Collider will increase luminosity or the number of proton-proton collisions by an order of magnitude. The upgrade depends on technology developments in superconducting magnets, very compact and precise superconducting RF cavities, and high-power superconducting links. More can be found at <http://hilumilhc.web.cern.ch>.

<sup>152</sup> At the energy frontier, researchers accelerate particles to the highest energies ever achieved by humanity and collide them to produce and study the fundamental constituents of matter and the architecture of the universe. At the intensity frontier, researchers use a combination of intense particle beams and highly sensitive detectors to make extremely precise measurements of particle properties, study some of the rarest particle interactions predicted by the standard model of particle physics, and search for new physics. For more information see <https://science.energy.gov/hep/research>.

- <sup>153</sup> Nuclear physics research activities in the low, medium, and high energy regime all depend on advanced accelerator technology. For example, the relativistic heavy ion collider (RHIC) is a 2.4 mile ring accelerator capable of colliding beams of heavy ions up to uranium. The Argonne Tandem LINAC Accelerator System (ATLAS) is a superconducting linear accelerator enabling study of nuclear structure and nuclear astrophysics for elements from hydrogen to uranium. More information about these and other facilities and about the nuclear physics program generally is available at <http://www.science.energy.gov/np>.
- <sup>154</sup> The seven grand challenges for accelerator research are described in more detail in the 2012 Accelerator Task Force report available at [http://www.acceleratorsamerica.org/report/accelerator\\_task\\_force\\_report.pdf](http://www.acceleratorsamerica.org/report/accelerator_task_force_report.pdf).
- <sup>155</sup> SRF cavities are resonators capable of achieving extraordinarily high (1,010) quality factors, providing very low energy loss and narrow bandwidth. This means that nearly all of the electrical energy can be applied to accelerating the beam and thus reducing the number of accelerating elements necessary to achieve a specified energy. SRF cavities are an enabling technology for future accelerators and upgrading existing accelerator facilities. More information can be found at <http://www.fnal.gov> or in Padamsee, H. S. "Superconducting Radio-Frequency Cavities." *Annual Review of Nuclear and Particle Science* (64), 2014; pp. 175-196. Available at: <http://www.annualreviews.org/doi/abs/10.1146/annurev-nucl-102313-025612>.
- <sup>156</sup> Upgrades to the relativistic heavy ion collider completed in 2012 increased luminosity by approximately four times and was enabled in part by a new 56 MHz SRF system and installation of 3D stochastic cooling. See Fischer, W. (May 2010) "RHIC Luminosity Upgrade Program." The 1<sup>st</sup> International Particle Accelerator Conference, 23 May-28 May, 2010. Upton, NY: Brookhaven National Laboratory, pp. 1227-12312010. Accessed August 21, 2015: <http://accelconf.web.cern.ch/AccelConf/IPAC10/papers/tuxmh01.pdf>.
- <sup>157</sup> The 12 GeV upgrade to CEBAF is enabled by installation of 10 new superconducting RF accelerating elements and upgrades to the magnets in the recirculation arcs to increase their strength. More information is available at <https://www.jlab.org/12-gev-upgrade>.
- <sup>158</sup> Fermilab and TJNAF will jointly be building the next generation SRF cavities and associated cryomodules that will enable development of the 4 GeV superconducting LINAC at the heart of the LCLS-II upgrade. More information is available at <http://www-bd.fnal.gov/LCLS>.
- <sup>159</sup> For more information about ASTA, see <http://www.fnal.gov/pub/science/particle-accelerators/asta.html>. For more information about TEDF, see <https://www.jlab.org/>.
- <sup>160</sup> Plasma wakefield acceleration relies on density waves in a plasma to transfer energy from a "drive" beam to an "accelerated" beam, much like a surfer can be accelerated by ocean waves. Because material ionization limits do not apply to plasmas, accelerating gradients well in excess of 50 GeV/m have been demonstrated.
- <sup>161</sup> The laser system at BELLA is capable of producing 40 joule pulses 40 femtoseconds in duration at one hertz frequency. More information is available at <http://loasis.lbl.gov/>.
- <sup>162</sup> Plasma wakefield acceleration R&D is also conducted at the Argonne Wakefield Accelerator Facility (AWAF) at ANL. AWAF maintains the world's two highest charge RF photoinjectors capable of 100 nC per bunch. More information is available at <http://gate.hep.anl.gov/awaf/>.
- <sup>163</sup> The 2013 Workshop on Laser Technology for Accelerators explores the R&D needed to bridge the gap between current laser systems and those needed for future accelerators. The workshop report is available at [http://science.energy.gov/~media/hep/pdf/accelerator-rd-stewardship/Lasers\\_for\\_Accelerators\\_Report\\_Final.pdf](http://science.energy.gov/~media/hep/pdf/accelerator-rd-stewardship/Lasers_for_Accelerators_Report_Final.pdf).
- <sup>164</sup> Available at: <http://www.bnl.gov/atf/>.
- <sup>165</sup> For more information on the development of compact light sources, see the 2010 "Report of the Basic Energy Sciences Workshop on Compact Light Sources." Available at: <http://science.energy.gov/~media/bes/pdf/reports/files/CLS.pdf>.
- <sup>166</sup> "Accelerators for America's Future." Washington, DC: U.S. Department of Energy, 2010. p. 6. Available at: <http://science.energy.gov/~media/hep/pdf/accelerator-rd-stewardship/Report.pdf>.
- <sup>167</sup> For an example of increased solar cell efficiency due to transition metal doping, see Kranz, L.; Gretener, C.; Perrenoud, J.; Schmitt, R.; Pianezzi, F.; La Mattina, F.; Blösch, P.; Cheah, E.; Chirilă, A.; Fella, C.M.; Hagendorfer, H.; Jäger, T.; Nishiwaki, S.; Uhl, A.R.; Buecheler, S.; Tiwari, A. N. "Doping of Polycrystalline CdTe for High-efficiency Solar Cells on Flexible Metal Foil." *Nature Communications* (4), 2013. Available at: <http://www.nature.com/ncomms/2013/130813/ncomms3306/full/ncomms3306.html>. For a review of heteroatom doping in carbon-based materials for energy applications, see Paraknowitsch, J. P.; Thomas, A. "Doping Carbons Beyond Nitrogen: An Overview of Advanced Heteroatom Doped Carbons with Boron, Sulphur and Phosphorus for Energy Applications." *Energy & Environmental Science* (6:10), 2013; pp. 2839-2855. Available at: <http://pubs.rsc.org/en/content/articlelanding/2013/ee/c3ee41444b#1divAbstract>.
- <sup>168</sup> For example, replacement of thermal techniques for drying metal coatings, which currently use approximately 166 MW of power, with electron beam technology could realize energy reductions of 95%. More examples of energy savings enabled by accelerator technology are described in "Accelerators for America's Future." Available at: <http://science.energy.gov/~media/hep/pdf/accelerator-rd-stewardship/Report.pdf>.
- <sup>169</sup> For example, a pilot facility in Poland uses electron beams to turn a mixture of flue gas and ammonia into saleable fertilizer. A pilot facility for electron beam treatment of waste water is currently operating in Korea. See "Accelerators for America's Future," available at <http://science.energy.gov/~media/hep/pdf/accelerator-rd-stewardship/Report.pdf>, for additional examples.
- <sup>170</sup> In close consultation with other Office of Science programs, the Office of High Energy Physics maintains an accelerator stewardship program to support accelerator R&D for applications outside discovery science. The myriad ways in which electron and ion accelerators are impacting society are described in the 2012 report "Accelerators for America's Future," available at <http://science.energy.gov/~media/hep/pdf/accelerator-rd-stewardship/Report.pdf> and at the associated Web site <http://www.acceleratorsamerica.org/index.html>.



- <sup>171</sup> Leemans, W. P.; Gonsalves, A. J.; Mao, H.-S.; Nakamura, K.; Benedetti, C.; Schroeder, C. B.; Tóth, C.; Daniels, J.; Mittelberger, D. E.; Bulanov, S. S.; Vay, J.-L.; Geddes, C. G. R.; Esarey, E. "Multi-GeV Electron Beams from Capillary-Discharge-Guided Subpetawatt Laser Pulses in the Self-Trapping Regime." *Physical Review Letters* (113:24), 2014; pp. 245002-1–245002-5. Available at: <http://dx.doi.org/10.1103/PhysRevLett.113.245002>.
- <sup>172</sup> Demarteau, M.; Yurkewicz, K. "Tools, Techniques, and Technology Connections of Particle Physics" U.S. Department of Energy, Office of Science, May 2014. Available at: <http://science.energy.gov/~media/hep/pdf/files/Banner%20PDFs/TTT-connections-May14.pdf>.
- <sup>173</sup> Ibid.
- <sup>174</sup> "Neutron and X-ray Detectors." Report of the Basic Energy Sciences Workshop on Neutron and X-ray Detectors. Washington, DC: U.S. Department of Energy Office of Science Office of Basic Energy Sciences, 2012. Available at: [http://science.energy.gov/~media/bes/pdf/reports/files/NXD\\_rpt\\_print.pdf](http://science.energy.gov/~media/bes/pdf/reports/files/NXD_rpt_print.pdf).
- <sup>175</sup> The full list of priority research directions are high-efficiency hard X-ray sensors, replacement of He-3 in neutron detectors, fast-framing X-ray detectors, high-speed spectroscopic X-ray detectors, very high-energy-resolution X-ray detectors, low-background signals, high-spatial resolution neutron detectors, improved acquisition and visualization tools, and improved analysis work flows.
- <sup>176</sup> The production responsibility for certain isotopes does not reside within IDPRA. This includes commercially available isotopes, the medical isotope molybdenum-99, isotopes for reactor fuels (uranium), and isotopes for weapons (e.g., plutonium and tritium).
- <sup>177</sup> The IPF facility (<https://www.lanl.gov/science-innovation/science-programs/office-of-science-programs/nuclear-physics/isotopes/index.php>) provides radioisotopes for a variety of applications, including medical diagnostics, fundamental nuclear physics, national security, environmental science, and industrial applications. Selected isotopes, including aluminum-26 and silicon-32, are only produced at IPF. IPF utilizes a 100 MeV proton beam extracted from the main Los Alamos Neutron Science Center and directed to a modern target irradiation facility.
- <sup>178</sup> The BLIP facility ([www.bnl.gov/cad/Isotope\\_Distribution/Isodistoff.asp](http://www.bnl.gov/cad/Isotope_Distribution/Isodistoff.asp)) prepares commercially unavailable radioisotopes for applications in nuclear medicine and other industries as well as R&D for production of new radioisotopes of interest to nuclear medicine. BLIP uses 200 MeV protons from the BNL LINAC, which is primarily used as an injector for the Relativistic Heavy Ion Collider.
- <sup>179</sup> Hot cell capabilities managed by the IDPRA are located at ORNL, LANL, PNNL, and BNL.
- <sup>180</sup> The DOE Isotope Program supports the extraction of He-3 from the NNSA tritium reserves and distributes it throughout the federal complex according to federal allocation processes. The DOE Isotope Program leads a White House Interagency group that determines and coordinates the He-3 distribution for federal purposes and was responsible for successfully mitigating the He-3 shortage from 2008.
- <sup>181</sup> The Isotope Program distributes a modest inventory of lithium-7 from the NNSA Y-12 facility for researchers and for manufacturing of radiation dosimeters. The nuclear power sector, which uses lithium-7 for modifying the chemistry in reactor cooling water systems, is currently reliant on Russian exports to meet demand. The Isotope Program is also currently supporting research on new methods of lithium-7 enrichment.
- <sup>182</sup> As of 2015, the DOE Isotope Program has supported the development of radioisotope production capabilities or isotope production R&D at seven universities: University of Washington; University of California-Davis; University of Wisconsin; University of Missouri; Washington University; Texas A&M University; and Duke University. Available at: <https://isotopes.gov/sites/sites.html>.
- <sup>183</sup> Available at: <https://isotopes.gov>.
- <sup>184</sup> Gamma-ray photons emitted by positron-emitting radionuclides are used in positron emission tomography to produce 3D images of the body. Many of the isotopes used, including carbon-11, nitrogen-13, and oxygen-15, have sufficiently short half-lives that on-site preparation via small cyclotrons is required. Production of radioisotopes or isotope pairs with both therapeutic and diagnostic/imaging capabilities (theranostics) is a growing area isotope production research.
- <sup>185</sup> Alpha particles produced by alpha decay are helium nuclei with an overall charge of 2+ and energy of approximately 5 MeV. They are highly ionizing and interact strongly with matter but have low penetrating power.
- <sup>186</sup> The Isotope Program supports the only domestic source of californium-252 production.
- <sup>187</sup> Multiple stable isotopes that are only available from Russia or the Netherlands are precursors to radioactive isotopes having applications in medicine, security, and manufacturing, among others. For example, strontium-88 is the precursor to strontium-89, which is used to treat bone cancer. Nickel-62 is the precursor to radioactive nickel-63, which is used as the active radiation source in detection systems for explosives and drugs. Selenium-74 is the precursor to selenium-75, which is used as a gamma radiography source.
- <sup>188</sup> A burning plasma is one in which the fusion process itself provides the dominant heat source for sustaining the plasma temperature.
- <sup>189</sup> ITER, located in Cadarache facility, Saint-Paul-lès-Durance, France, is designed to produce 500 MW of power while requiring only 50 MW to operate.
- <sup>190</sup> The upgrade to NSTX doubled the magnetic fields strength and plasma current and increased plasma pulse length from one to five seconds.
- <sup>191</sup> DIII-D and NSTX-U have different aspect ratios, defined as the ratio of the plasma radius dimension to the major radius of the confinement device. Aspect ratio is a leading factor imbedded in the physical laws governing stability of a fusion plasma confined in a toroidal geometry.
- <sup>192</sup> A current list of the SC-FES SciDAC partnerships is provided in Supplemental Information (section 9B).
- <sup>193</sup> The science challenges and applications of low temperature (or partially ionized) plasmas were articulated during the 2008 Fusion Energy Sciences Workshop on Low Temperature Plasmas. The resulting report, "Low Temperature Plasma Science: Not Only the Fourth State of Matter but All of Them," is available at [http://science.energy.gov/~media/fes/pdf/workshop-reports/Low\\_temp\\_plasma\\_workshop\\_report\\_sept\\_08.pdf](http://science.energy.gov/~media/fes/pdf/workshop-reports/Low_temp_plasma_workshop_report_sept_08.pdf).

- <sup>194</sup> (a) Paz-Soldan, C.; Nazikian, R.; Haskey, S. R.; Logan, N. C.; Strait, E. J.; Ferraro, N. M.; Hanson, J. M.; King, J. D.; Lanctot, M. J.; Moyer, R. A.; Okabayashi, M.; Park, J.-K.; Shafer, M. W.; Tobias, B. J. "Observation of a Multimode Plasma Response and Its Relationship to Density Pumpout and Edge-Localized Suppression." *Physical Review Letters* (114:10), 2015; pp. 105001-1-5 . Available at: <http://journals.aps.org/prl/abstract/10.1103/PhysRevLett.114.105001#fulltext>. (b) Nazikian, R.; Paz-Soldan, C.; Callen, J. D.; deGrassie, J. S.; Eldon, D.; Evans, T. E.; Ferraro, N. M.; Grierson, B. A.; Groebner, R. J.; Haskey, S. R.; Hegna, C. C.; King, J. D.; Logan, N. C.; McKee, G. R.; Moyer, R. A.; Okabayashi, M.; Orlov, D. M.; Osborne, T. H.; Park, J.-K.; Rhodes, T. L.; Shafer, M. W.; Snyder, P. B.; Solomon, W. M.; Strait, E. J.; Wade, M. R. "Pedestal Bifurcation and Resonant Field Penetration at the Threshold of Edge-Localized Mode Suppression in the DIII-D Tokamak." *Physical Review Letters* (114:10), 2015; pp. 105002-1-5 . Available at: <http://journals.aps.org/prl/abstract/10.1103/PhysRevLett.114.105002>.
- <sup>195</sup> "Computational Materials Science and Chemistry: Accelerating Discovery and Innovation Through Simulation-Based Engineering and Science." Report of the Department of Energy Workshop on Computational Materials Science and Chemistry for Innovation, July 26–27, 2010. Available at: [http://science.energy.gov/~media/bes/pdf/reports/files/cmssc\\_rpt.pdf](http://science.energy.gov/~media/bes/pdf/reports/files/cmssc_rpt.pdf).
- <sup>196</sup> "From Quanta to the Continuum: Opportunities for Mesoscale Science." A Report for the Basic Energy Sciences Advisory Committee Mesoscale Science Subcommittee, September, 2012. Available at: [http://science.energy.gov/~media/bes/pdf/reports/files/OFMS\\_rpt.pdf](http://science.energy.gov/~media/bes/pdf/reports/files/OFMS_rpt.pdf).



## Issues and RDD&D Opportunities

The goal of energy technology development programs, whether in the private sector or in government institutions, is to maximize the positive impact of research, development, demonstration, and deployment (RDD&D) portfolio investments. To evaluate total impacts, research institutions must consider multiple impact metrics that address energy-linked economic, security, and environmental goals from business and public perspectives. Portfolio analysis is widely employed, but at varying levels of thoroughness, analytic rigor and transparency. Many tools for technology planning and projection, analysis, metrics calculation, and impact evaluation exist already, but are not necessarily fully developed or packaged in a way that can be used directly for evaluating energy portfolios. This chapter accomplishes the following:

- Provides a suggested, iterative process to shape an energy portfolio and estimate the potential impacts of particular RDD&D activities on key national goals
- Articulates the current state of integrated technology assessment
- Gives examples of sector-specific applications of metrics and tools for technology analysis in use in various organizational contexts (i.e., corporate, nonprofit, academic, and government)
- Identifies gaps in technology assessment capabilities

# 10

## Concepts in Integrated Analysis

### 10.1 Introduction

The goal of a technology program's allocation and prioritization approaches is to identify research, development, demonstration, and deployment (RDD&D) opportunities with the greatest benefits while also considering their risks. The technology challenges and opportunities presented in the technology sector chapters (3–8) on energy-related RDD&D, together with integrated analysis approaches outlined in this chapter, can provide key insights on how to provide decision makers with information that will enhance their ability to understand trade-offs among various energy portfolios.

The purpose of this chapter is to articulate the current state of integrated technology assessment and identify gaps in technical assessment capabilities needed for integrated analysis. The chapter does not provide a definitive process nor perform any of the calculations necessary to begin to evaluate the many RDD&D investment opportunities that have been explored in the preceding technology sector chapters; but instead, provides a framework that can be utilized to conduct such analysis.

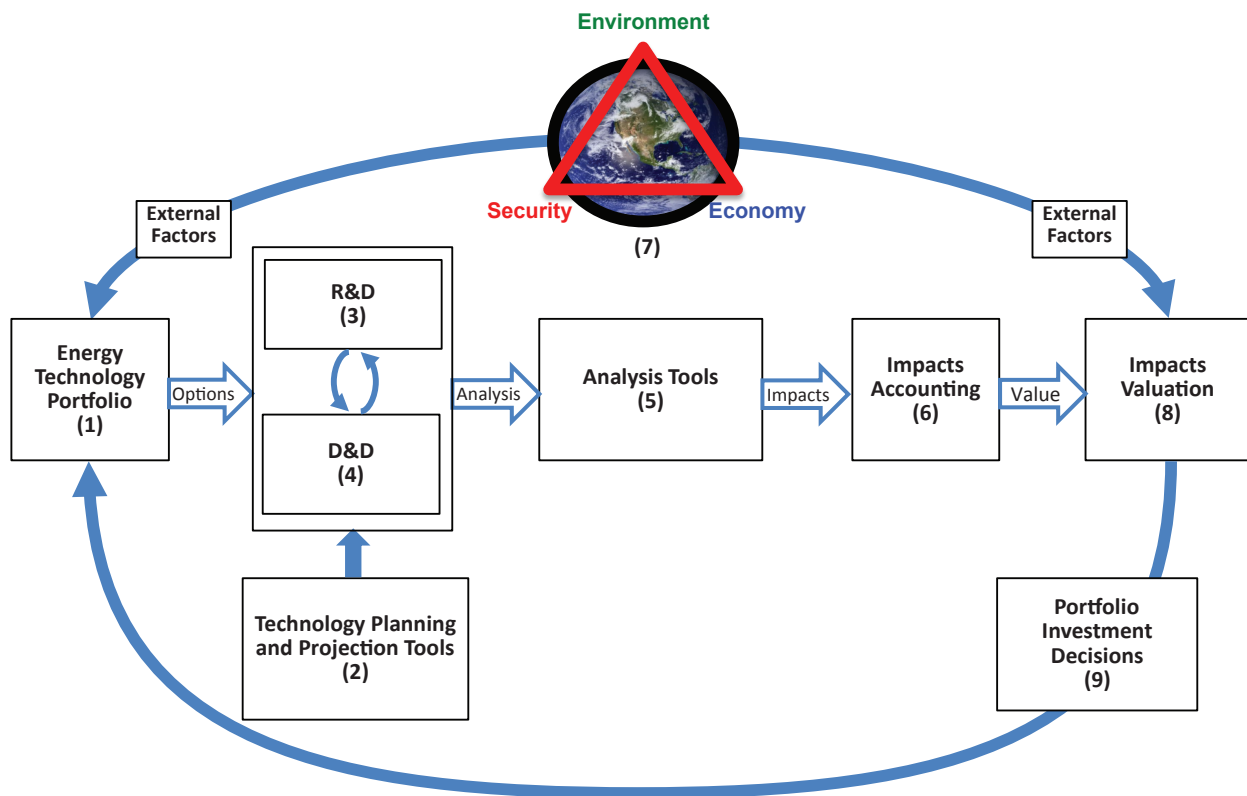
In particular, Figure 10.1 indicates the overall flow of the chapter and provides a suggested, iterative decision-making process to shape an energy portfolio and estimate the potential impacts of particular RDD&D activities on key national goals. It shows nine distinct steps in the RDD&D decision-making process, with each step numbered sequentially: 1) Starting with a portfolio of energy technologies, 2) a combination of technology planning and projection tools is used to 3) estimate the potential advance in capabilities through research and development. These tools are discussed in Section 10.2.2 of this chapter and include approaches ranging from simply stating a research and development (R&D) goal, to providing a subjective range of cost and performance metrics, to a formal elicitation of probabilistic risk estimates. Included are a number of tools and concepts described briefly below in this section and developed more fully in the rest of the chapter.

4) Demonstration and deployment (D&D) activities have several interactions with R&D. First, R&D progress will largely determine when and how much D&D activity is warranted, as deployment is substantially driven by costs that are dependent upon technical progress. Second, D&D activities that drive economies of scale and inform experience or learning processes may require further research activity in certain areas, stimulating feedbacks to R&D.

5) Estimates of the potential impact of overall RDD&D activities are developed next using analysis tools. Approaches include creating a range of potential growth outcomes over time, quantitatively modeling market penetration within a particular sector, or using an economic model to forecast market penetration and examine cross-sector impacts.

6-7) The deployment of energy technology RDD&D will have a variety of impacts on national security, economics, and the environment, illustrated in the figure as a triangle around the image of Earth.<sup>1</sup> Each high-level concept represents a number of impacts, quantified as metrics, that are discussed in Section 10.2.3.

Figure 10.1 Overall Flowchart of an RDD&amp;D Decision-Making Process



Determining appropriate metrics at the individual technology, technical system, sector, and integrated (systemwide) levels is a non-trivial task, but is vitally important to fairly assess portfolio impacts across a wide range of dimensions.

8) Evaluation tools such as options space and wedge analysis allow decision makers to consider multiple alternative approaches to achieve their high-level goals (see Section 10.2.4). Another type of evaluation tool is integrated assessment modeling (IAM), which takes environmental impacts into account in energy and economic models. This must be done in the context of a complex and evolving “background” of economic, political, institutional, and social forces that interact with and are shaped by energy technologies. Moreover, stochastic analysis is needed to overlay all of these approaches to take into account a wide range of factors that impinge upon outcomes. The wider the range of outcomes considered, the more that portfolios can be evaluated for robustness. The latter quality, robustness, should be quantified as a key high-level metric.

Technology outcomes depend critically on the human element at all levels, including individual consumers, building managers, energy suppliers, product designers, and high-level R&D program managers. Decision science tools can help our understanding, are critical to realistic modeling, and can lead to better RDD&D design. These concepts are also discussed in Section 10.2.4. Example applications of tools for technology analysis are provided at the end of this section.

9) A proposed approach of modeling, visualizing, interpreting, and ultimately making RDD&D portfolio investment decisions is discussed in Section 10.4. Reducing the volume of data to a level that provides insight to decision makers, while avoiding paralysis from “information overload” and the potential for bias arising from too narrow a range of considered data, is a formidable challenge.



The tables found in Section 10.5 enumerate the issues, questions, and metrics that might be considered in evaluating or planning portfolio investments. This section also includes a summary of RDD&D activities needed to improve these tools and decision-making capabilities.

## 10.2 Technology Assessment

Various tools, metrics, and concepts that can inform portfolio analysis are discussed here. This section describes their capabilities separately although for decision-making purposes one would likely use more than one to assess a portfolio.

### 10.2.1 Risk and Uncertainty

Risk and uncertainty are key characteristics of R&D programs. Attempting to do what no one has done before may sometimes end in failure, just as it may sometimes lead to extraordinary success. There are important distinctions, connections, and dependencies between different types of risks (i.e., technical versus market risk).

As considered here, risk can be characterized by the total uncertainty about a future cost and performance of a technology under RDD&D and its impact (usually assessed along multiple dimensions; see discussion on metrics in Section 10.2.3). Sometimes risk is colloquially used to refer only to bad outcomes, but risk refers to—and considers the weighted effects of—all outcomes. Understanding the relative risk and potential benefits of different projects is important in assigning value to RDD&D opportunities within a portfolio. Moreover, risks occur over different time horizons, further complicating a comparison of relative value. For example, an outcome with a potential impact in five years will be judged differently than one whose impact is evaluated over twenty or fifty years. Such time trade-offs are common in energy RDD&D investments, as some are focused on short-term benefits, while others may be multidecadal, but the potential impacts are typically larger. Simple economic discounting is sometimes appropriate, but the resulting risk calculation will depend on the choice of discount rate and the time horizon under consideration. Trade-offs between public (e.g., DOE) and private investment must also be evaluated.

### 10.2.2 Technology Planning and Projection

This section discusses four assessment tools as they are applied to technology RDD&D. Technology Readiness Levels are used to indicate the status of the technology. Technology roadmapping is used to plan, usually quantitative, goals for technologies and chart RDD&D pathways to achieve them. Expert elicitation is used to develop projections of the potential future cost and performance of technologies. Finally, experience curve analysis uses observed past rates of improvement in a technology to project its potential future cost and performance. Each of these assessment tools is discussed briefly in turn.

#### Technology Readiness Levels

Technology Readiness Levels (TRLs) identify the maturity level of a technology as well as its planned progression during the course of a project's execution. TRLs first employed by the National Aeronautics and Space Administration (NASA) and formalized to nine levels, denoted TRL 1 through TRL 9.<sup>2</sup> This scale has since gained widespread acceptance outside of NASA.<sup>3,4</sup> The lowest level, TRL 1, indicates that basic principles have been observed and reported, and it is the first step in taking an idea toward practical application. On the other end, a technology that has achieved TRL 9 has been built and “flight proven” through successful mission operations. While TRLs have proven useful to many agencies, they also suffer from drawbacks, most notably the lack of quantitative or physical characteristics in defining TRLs, exposing them to potential user bias. In addition, TRLs typically encompass many subsystem technologies that can exist at multiple levels

of development, raising the question of what TRL an overall technology system should receive. Also, TRLs do not allow ready comparisons across disparate technologies and time frames, and they do not adequately characterize early stages of applied RDD&D.

### Technology Roadmapping

Technology roadmapping (TR) provides information to support technology investment decisions by identifying critical technologies and technology gaps, tracking the performance of individual and potentially disruptive technologies, and identifying opportunities to leverage RDD&D investments.<sup>5</sup> Research institutions commonly use TR to create flexible RDD&D investment strategies that address complex barriers.<sup>6</sup> According to Garcia and Bray (1997),<sup>7</sup> technology roadmapping is “critical when the technology investment decision is not straightforward,” which could be due to the availability of multiple alternatives, the need for coordinating the development of multiple component technologies (e.g., as part of a system), or the time horizon in which a technology is needed.<sup>8</sup>

### Expert Elicitation

Expert elicitation is used to address risk and uncertainty in forecasts of future technology costs by relying on experts familiar with the technology. The method emphasizes both quality and diversity of expertise. Collectively, the experts represent a large breadth of knowledge to inform where “observable data [are] sparse or unreliable, and potentially useful data [are] unpublishable or proprietary.”<sup>9</sup> Expert judgment can fall prey to a number of biases, but these can be moderated with appropriate questioning techniques.<sup>10</sup>

Expert elicitation has been used extensively in some fields—with acknowledged challenges in its application<sup>11</sup>—but it has been used relatively little in energy technology RDD&D. Examples of such expert elicitation for energy technologies have included photovoltaics, nuclear power, and carbon capture and storage.<sup>12</sup> One approach that has had some initial testing is to conduct expert elicitation on potential improvements in physical (and cost) characteristics baselined against known physical phenomena, and to then use these in a reduced form energy-economic model on which Monte Carlo simulation is done to generate probability distributions of potential performance and cost improvements over time.<sup>13</sup> Portfolio analyses can then be developed across dimensions of risk, return, time frame, and other metrics. Challenges include controlling various biases, and limiting the cost of and time required for the expert elicitation process. These costs should be considered in the context of the scale of investment in the research. Further development and testing of this type of expert elicitation approach in conjunction with reduced form system modeling to provide early estimates of the potential of particular RDD&D pathways could be done to determine its utility as an interim step before a full system engineering analysis is possible.

### Experience Curve Analysis

Experience (or technology learning) curve analysis models the widely accepted mechanism through which technology cost reductions can occur, a concept originating from observations that manufacturing processes improve as production volume increases.<sup>14</sup> This has important implications for understanding past technology developments and program benefits, as well as a potential tool for forecasting technology growth for policy planning and modeling scenarios.

Economies of scale, R&D, regulatory environments, supply/demand, and material and component prices all affect the price of a given technology. Efforts have been made to distinguish the individual importance of these factors, which is useful when projecting forward based on learning rates derived from historical data as well as R&D investment and deployment activities. At a minimum, R&D and incentives that support deployment are often necessary to get early stage technology to the marketplace.

Overall, learning or experience curve analysis can be a useful tool for modeling and planning, but the limitations and uncertainties of these methods must be well-understood and incorporated into any decision-making process. This approach is most applicable to commercialized, non-commodity, scalable, component-level technologies, because manufacturing processes and production and cost histories are in principle readily available. It is also useful to consider how forecasts of technological progress (e.g., costs, performance metrics) can be an input to forward-looking expert elicitation.

### 10.2.3 Analysis Tools and Metrics

Quantitative assessment tools can provide rigor and robustness to portfolio decision making. These tools often rely on metrics, such as levelized cost of energy and greenhouse gas (GHG) emissions. Metrics do not define policies or goals but facilitate evaluation and implementation of multi-component policies to meet particular goals. To evaluate the extent to which different RDD&D portfolios and component activities can meet diverse goals, it is important to employ a consistent and common set of tools and metrics to enable effective comparison.

Metrics will differ at the level of an individual technology, technology category (e.g., technologies that provide a similar type of service but may differ in details such as gasoline vs. electric vehicle), sector, and overall energy system. However, it is challenging to compare technologies that provide different types of services; a good example is comparing modes of personal transportation (e.g., walking, bicycling, driving, and flying).

All choices of metrics contain implicit value-related judgments such as type of effect considered and weighting of effects over time.<sup>15</sup> Moreover, estimating these metrics requires common methodologies across all technologies. There is no single metric that can be used to comprehensively assess and compare RDD&D opportunities. Moreover, all metrics do not carry equal weight; the issue of weighting or combining metrics is discussed in Section 10.4.

In this section, brief discussions of metrics that have been identified as most relevant to energy technologies will be presented, along with quantitative examples.

#### Life-Cycle Assessment Overview

For effective comparison of RDD&D opportunities, many metrics are defined in a way that accounts for the entire life cycle of a process or product as part of a life-cycle assessment (LCA). LCA is a methodology that assesses the inputs, outputs, and impacts of a product or process from raw material extraction through end-of-life management (e.g., disposal, recycling, or repurposing). There are typically four steps in completing an LCA: goal definition, life-cycle inventory (LCI), life-cycle impact assessment (LCIA), and interpretation of results.<sup>16</sup> Although energy and material-related metrics are often generated during the LCI step (e.g., energy required to convey one person a distance of one kilometer), many of the environmental metrics are determined in the LCIA step, which characterizes and assesses the environmental burdens identified in the LCI (e.g., global warming potential). The final step, interpretation of results, determines the level of confidence of the results through identification of significant parameters for each impact category, assessment of completeness of the study, and effectively communicates conclusions that are reflective of the original goal of the LCA.<sup>17</sup> The principles of LCA are described in ISO 14040:2006, and the steps and framework are described in ISO 14044:2006.

The above mainly describes the approach used in retrospective LCA that is generally applied to existing technologies. Another type is prospective (or anticipatory) LCA that can be applied to emerging technologies that do not yet exist.<sup>18</sup> Both types of LCA are important and valuable, but prospective LCA has additional challenges, such as data uncertainty and availability, the rapid pace of technological innovation, thorough understanding of environmental impacts, and the need for stakeholder engagement, that inhibit its widespread application.<sup>19,20</sup>

Key LCA metrics for energy RDD&D include costs, material flows, GHG emissions, water consumption, and land use. These metric categories are discussed in subsequent sections below.

### Levelized Cost of Energy

The levelized cost of energy (LCOE) represents the projected cost of providing one unit of energy for a particular energy service over the lifetime of the asset (for example, \$/kilowatt-hour (kWh) for electricity, or \$/megajoule for fuel). The LCOE calculation typically includes the capital investment cost, fixed and variable operation and maintenance costs, and fuel costs.<sup>21</sup> LCOE is an easily understood metric that can be useful in developing research goals for a particular technology, evaluating investments and trade-offs in alternative pathways to achieve those goals, and tracking progress in that technology towards those goals. Waterfall charts of cost and performance are commonly used. Other factors may include the weighted average capital cost (WACC), annual capacity factor, and incentives such as accelerated depreciation and federal or state level tax credits.

Although LCOE is useful in illustrating the economics of technologies with similar characteristics (i.e., dispatchability or load profiles), for electricity generation LCOE can be misleading when comparing technologies with different operating characteristics. This is because LCOE does not account for certain important attributes for power generation. It is especially problematic to compare dispatchable with variable generation technologies,<sup>22,23</sup> or to compare baseload capacity with those used for peaking or for reliability purposes. For example, LCOE does not account for the value of capacity for meeting peak demands, ability to dispatch generation, differences in the value of energy at different times of the year or day (i.e., on-peak, off-peak, etc.), ancillary services, or other costs for grid integration. Furthermore, LCOE is very sensitive to the assumptions for WACC, installation costs, fuel prices, materials costs, tax or other incentives, interconnection costs, and capacity factors.<sup>24</sup> Finally, regional conditions can impact LCOE, particularly for renewable generation technologies whose capacity utilization is governed by factors such as solar insolation or weather patterns. In real-world applications, technologies in a given region with substantially different LCOEs can often be competitive with one another for reasons other than cost. At the system level, the overall cost of providing electricity is used to compare different portfolios, taking into account the level of reliability.

For new technologies, it is also necessary to evaluate what their cost will be with significant deployment, e.g., for the “Nth” plant. Empirical learning curves are typically used to represent long-term cost projections, but the actual experience across technologies varies widely, from strongly positive learning curves (often 20% or more cost reduction per cumulative capacity doubling) to negative values (sustained cost increases, despite continued deployment).<sup>25</sup> The underlying assumptions for these factors thus can have a significant impact.

### Greenhouse Gas Emissions

Most energy-consuming processes generate GHG emissions that contribute to global climate change. While carbon dioxide (CO<sub>2</sub>) is the best-known GHG and is fairly long-lived, other gases including methane (CH<sub>4</sub>), nitrous oxide (N<sub>2</sub>O), and hydrofluorocarbons (HFCs) also induce net radiative forcing effects (that is, atmospheric warming). GHG emissions are usually expressed in terms of “CO<sub>2</sub>-equivalent” (CO<sub>2</sub>e) emissions, a quantity that is obtained by scaling each gas emission according to its global warming potential (GWP), which in turn is defined as the cumulative radiative forcing per unit mass over a specified timescale relative to an equal mass of CO<sub>2</sub>.<sup>26</sup> The choice of timescale has a large effect on the value of GWP: for CH<sub>4</sub> or HFC-134a, with atmospheric lifetimes of about twelve years, the twenty-year GWP is approximately three times as large as the corresponding one hundred-year GWP, whereas for longer-lived gases (e.g., N<sub>2</sub>O), the twenty- and one hundred-year GWP values are almost identical. The United Nations Framework Convention on Climate Change adopted the time horizon of one hundred years for GWP, and this choice has been widely replicated in U.S. policies and analysis at the federal, state, and local levels.<sup>27</sup> The selection of time horizon depends upon what impacts are to be evaluated and does not otherwise have scientific significance.<sup>28,29</sup>

In terms of climate change impact, processes are often characterized in terms of “GHG intensity,” that is, a mass (e.g., metric ton<sup>30</sup> of carbon dioxide equivalent [tCO<sub>2</sub>e]) emitted per unit energy consumed (or other suitable metric). In this way, the GHG impact for an equivalent amount of energy service can be assessed. Another common GHG metric is the cost per tCO<sub>2</sub>e reduced or avoided, which allows cost comparison of different GHG abatement strategies.

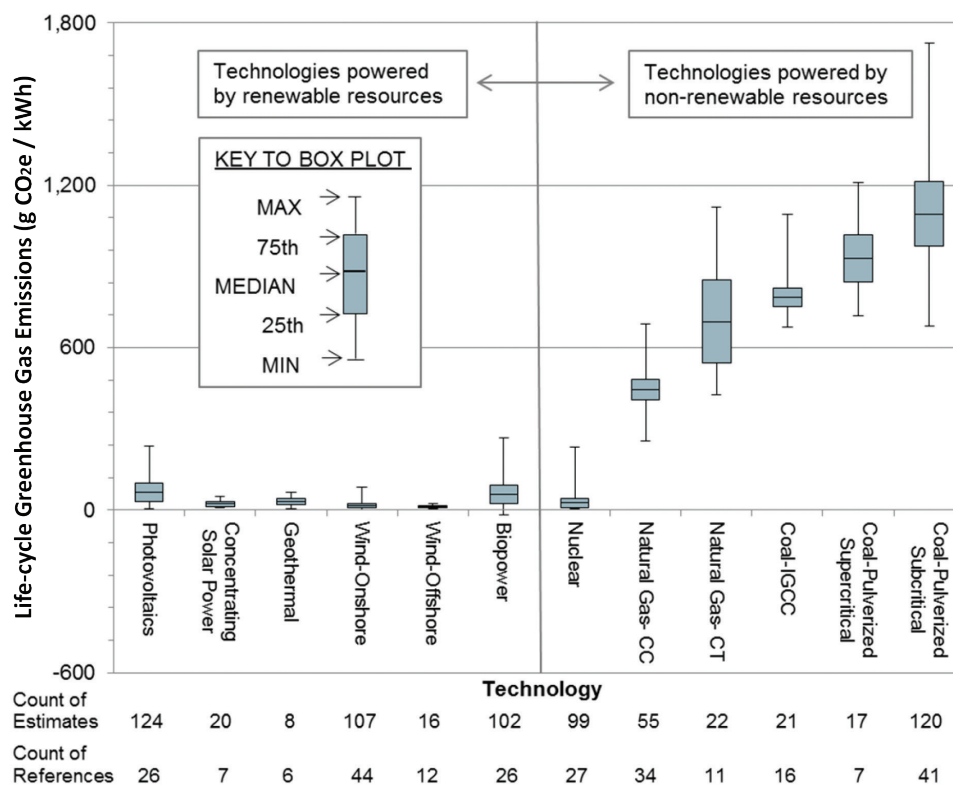
In Figure 10.2, GHG emissions for various electric generation technologies are compared.<sup>31</sup> In particular, two types of uncertainty bounds are shown, along with the number of estimates and references upon which each reported value is based, illustrating the relative uncertainty in GHG emissions for many technologies.

### Other Emissions

In addition to GHGs, other emissions, such as criteria pollutants,<sup>33</sup> persistent organic pollutants,<sup>34</sup> and hazardous air pollutants<sup>35</sup> have negative impacts on the environment and human health. Moreover, some pollutants are typically emitted to water and soils.

Each year’s version of the U.S. Energy Information Administration’s Annual Energy Outlook<sup>36</sup> incorporates the projected impacts of existing air quality regulations on emissions. Emissions of nitrogen oxides (NO<sub>x</sub>), sulfur dioxide (SO<sub>2</sub>), and mercury (Hg) are tracked by this effort, although particulate matter (PM) and

**Figure 10.2** Illustrative Comparison of Life-Cycle GHG Emissions of Various Electricity Generation Technologies<sup>37</sup>



Note: Reference has “harmonized” original data to correct for differences in a number of input assumptions, resulting in reduced variance. “Count of estimates” refers to the number of separate sources of data. “Count of references” refers to the number of separate studies used to provide data. Key: CC = combined cycle; CT = combustion turbine; and IGCC = integrated gasification combined cycle.

numerous other substances are also of concern to human health. Table 10.1 presents average emissions factors resulting from national and regional air pollution regulations for the six criteria air pollutants for selected combustion technologies.

**Table 10.1** National Average Energy Efficiencies, Technology Shares for Each Fuel Type, and Criteria Air Pollutant Emission Factors (g/kWh) of the U.S. Power Sector in 2010<sup>37</sup>

Fuel type, combustion technology	Efficiency	Technology shares	NO <sub>x</sub>	SO <sub>x</sub>	PM <sub>10</sub>	PM <sub>2.5</sub>	CO	VOC
Biomass, ST	21.9%	100.0%	0.9267	0.603	2.814	1.9763	4.7546	0.1349
Coal, IGCC	34.8%	0.1%	0.1167 <sup>a</sup>	0.0403 <sup>a</sup>	2.4693	0.7198	0.02191	0.0012
Coal, ST	34.7%	99.9%	1.141	3.1998	0.2836	0.1994	0.1221	0.0147
NG, CC	50.6%	82.1%	0.1175	0.0041	0.0009	0.0009	0.098	0.0018
NG, GT	31.6%	5.5%	0.3452	0.0172	0.0386	0.0386	0.4458	0.0114
NG, ICE	32.8%	0.9%	3.0829 <sup>a</sup>	0.0061 <sup>a</sup>	0.4718	0.4718	3.8187	1.1102
NG, ST	32.3%	11.5%	0.8653	0.1745	0.0426	0.0426	0.4821	0.032
Oil, GT	29.4%	18.2%	2.9759	0.9438	0.3011	0.0763	0.0181	0.003
Oil, ICE	36.3%	4.6%	4.7442 <sup>a</sup>	0.2274 <sup>a</sup>	0.0138	0.013	0.0315	0.0119
Oil, ST	33.0%	77.2%	4.4825	7.6442	0.1797	0.1395	0.1676	0.0216

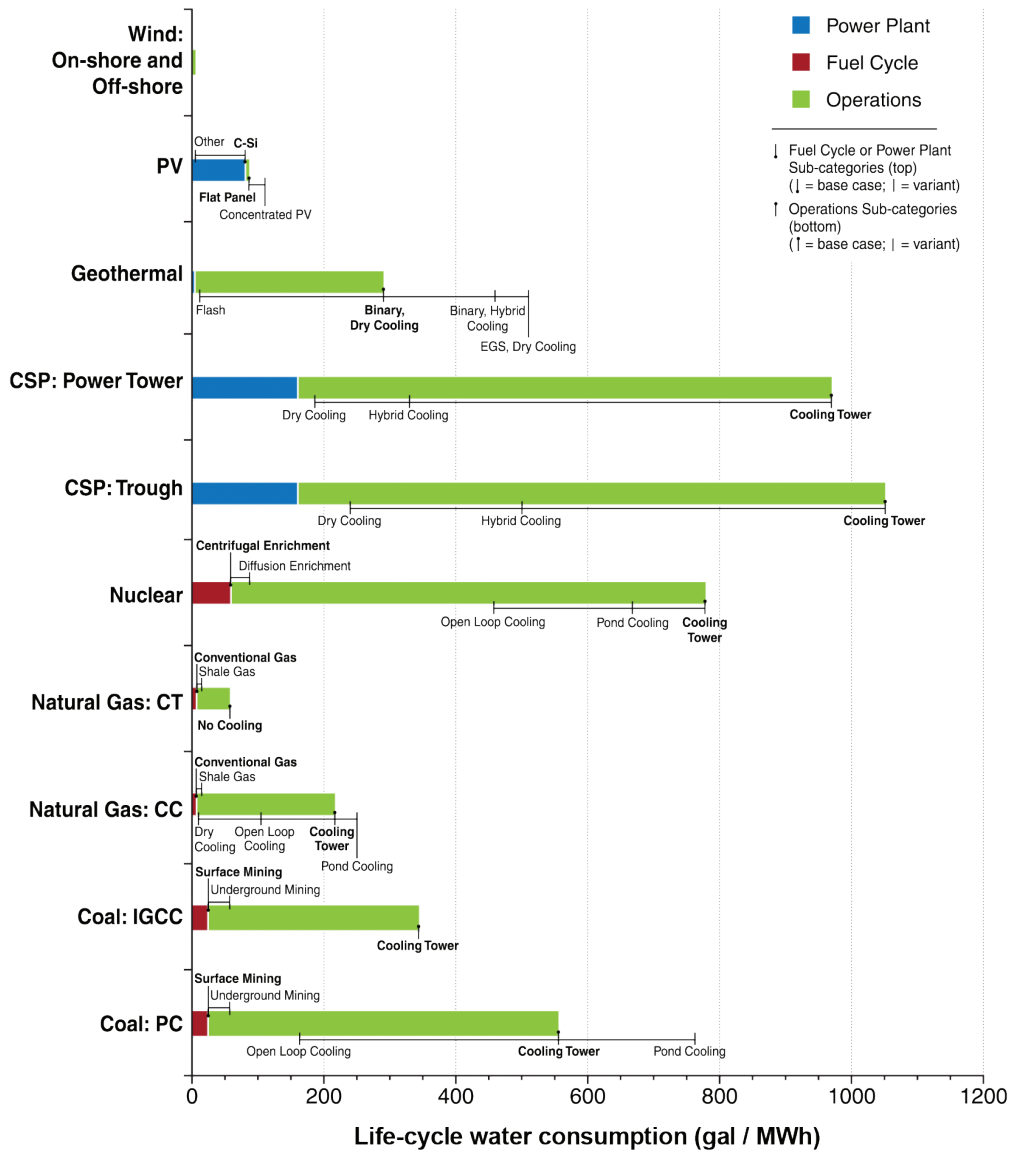
Notes: Plant-level (not life-cycle) emissions. Technology share is the ratio of the amount of electricity generated by each technology to the total electricity generation by fuel type. Key: NO<sub>x</sub> = nitrogen oxides, SO<sub>x</sub> = sulfur oxides, PM<sub>10</sub> = 10 μm particulate matter, PM<sub>2.5</sub> = 2.5 μm particulate matter, CO = carbon monoxide, VOC = volatile organic carbon, ST = steam turbine, IGCC = Integrated Gasification Combined Cycle, NG = natural gas, CC = combined cycle, GT = gas turbine, ICE = internal combustion engine.

<sup>a</sup> Adjusted based on averaged 2007 emission factors for coal IGCC, NG ICE or oil ICE as appropriate, and the 2007 to 2010 emission reduction rates of NO<sub>x</sub> and SO<sub>x</sub> for coal-, NG- or oil-fired power plants, respectively.

## Water Use

Water is used in many phases of the energy life cycle from resource extraction and fuels production to electricity generation. With changes in climate, technology, and society, it is increasingly important to understand the withdrawal (or throughput), consumption, and degradation of water.<sup>40,41</sup> While some technologies use very little water (e.g., wind, solar photovoltaic [PV]), others are far larger consumers, with biofuels from irrigated crops being among the highest consumers per unit of useful output energy.<sup>42</sup> Thermal power plants (i.e., those using steam to spin turbines) fall somewhere in the middle, with the amount of water “lost” (to the atmosphere) depending strongly on whether it is used in a once-through (low loss) or recirculated (high loss) cooling fashion, but with a trade-off in higher degradation (via thermal loading<sup>43</sup>) to the water in once-through cooling. Figure 10.3 compares water consumption among electricity generation technologies as an example of the range of values that can be encountered depending on specific system assumptions. However, estimates from other sources may produce quite different results.

**Figure 10.3** Life Cycle Water Consumption Estimates for Various Electricity Generation Technologies<sup>44</sup>



Notes: Not all cooling options are shown; for instance, more expensive, dry cooling (with zero water consumption and withdrawal) is an option for most plants. Key: PV = solar photovoltaic; C-Si = crystalline silicon; EGS = enhanced geothermal system; CSP = concentrating solar power; CT = combustion turbine; CC = combined cycle; IGCC = integrated gasification combined cycle; and PC = pulverized coal, sub-critical.

## Land Use

Extracting, producing, and consuming energy all require land in some way. Fossil fuels and biomass require a significant area of land for mines, wells, and fields. Land is required for electric power generation facilities. Some of the more obvious land uses are well-accounted for in the literature, while others, such as embedded

land use in transportation, are mostly absent. Comparing the required land areas can inform decision making for development and prioritization of RDD&D efforts to reduce technology or process footprints.

One major challenge to understanding land use in the energy sector is that there is no definitive source for land use energy intensity (LUEI), and as a result, metrics often have different units that are not always easily comparable.<sup>45</sup> The importance of the appropriate unit is key to ensure normalization of LUEI over plant lifetime. Table 10.2 presents one LUEI unit in meters squared per megawatt and values across various energy technologies. It should be stressed that these are examples only, and moreover, for land use, methodological issues remain that make comparisons across certain types of technologies extremely problematic. Most significantly, the metric does not account for intensity, or degree, of impact.<sup>46</sup> Extreme parameter combinations, changes in technology, and definitional ambiguity may also contribute to estimate variations. A further complicating factor is time-to-recovery. These issues are delineated in more detail in Section 10.5.7.

**Table 10.2** Representative Land Use Energy Intensity Estimates for a Variety of Electricity Generating Technologies<sup>47</sup> (Note that these estimates are from different studies and are not comparable as they use different assumptions for what is included and how it is included—i.e., they are not harmonized)

Energy technology	m <sup>2</sup> /MW	System boundary Power plant site only; does not consider energy resource mining or collection, processing, or transport area, or land used for waste disposal
Biomass: direct-fired	9,000–45,000	Power plant site only
Coal	270–8,000	Power plant site only
Coal: CCS	12,000	Power plant site only
Nuclear	6,700–13,800	Low estimate is site only. High estimate includes transmission lines, water supply, and rail lines, but does not include land used to mine, process, or dispose of wastes.
Energy technology	m <sup>2</sup> /MW	System boundary Energy resource extraction area plus power plant site
Biomass: gasification	3,000,000	Site and crop area. Area used primarily driven by biomass productivity and power plant efficiency.
Coal (site and upstream)	40,000	Site and strip mining included
Geothermal: hydrothermal	1,200–150,000	Low estimate is for the site only. Upper estimate includes well-field and plant.
Geothermal: hot dry rock	4,600–17,000	Includes well-field and plant
Hydropower: reservoir	20,000–10,000,000	Site of generators and reservoir
Solar: PV	10,000–60,000	Site of PV system, which includes the area for solar energy collection. PV systems on pre-existing structures have essentially no net increase in land use.
Solar: thermal	12,000–50,000	Site of concentrating solar thermal system, which includes the area for solar energy collection
Wind	2,600–1,000,000	Low-end value is for the site only, which includes the physical footprint of the turbines and access roads. The high-end value includes the land area between turbines, which is typically available for farming or ranching (see Section 10.5.7).



## Materials and Criticality

All energy technologies require materials, but the types and amounts of materials consumed vary widely. Some technologies require only common, plentiful materials such as steel, glass, and concrete, but many require varying amounts of rare materials such as noble metals. Moreover, the degree of material recycling varies widely from technology to technology and material to material, and design, as well as consumer behavior and social attitudes can have a big impact on how easily recyclable certain materials will be. Identifying materials and understanding their flows including reuse, remanufacture, recycling, and disposal are key to the inventory step in LCA. Examples of material inventories for selected vehicle types and electric power plants are presented in Table 10.3 and Table 10.4. Key materials by mass per vehicle or energy lifetime include steel, concrete, cement, glass, and aluminum.<sup>48</sup>

**Table 10.3** Range of Material Requirements for Select Passenger Car Technologies<sup>51</sup>

Materials (pounds per vehicle lifetime unless otherwise noted)	Passenger car (160,000-mile lifetime)		
	ICEV	EV	FCV
Vehicle weight	2,900	3,700	3,500
Steel	1,900	2,600	2,200
Cast iron	310	74	55
Wrought aluminum	63	39	170
Cast aluminum	130	200	110
Copper/brass	53	180	160
Glass	82	130	100
Average plastic	320	450	370
Rubber	300	310	300
Carbon fiber-reinforced plastic for general use	0	0	140
Carbon fiber-reinforced plastic for high-pressure vessels	0	0	140
Nickel	0	0	3
PFSA (Nafion117 sheet)	0	0	12
Carbon paper	0	0	12
PTFE	0	0	3
Carbon and PFSA suspension (Nafion dry polymer)	0	0	1
Magnesium (g, per-vehicle lifetime)	230	360	280
Platinum (g, per-vehicle lifetime)	7	0	92
Others	54	110	84

Note: Assumes conventional materials for passenger cars. Key: ICEV=internal combustion engine vehicle; EV=electric vehicle; FCV=fuel cell vehicle; PFSA = perfluorosulfonic acid; PTFE = polytetrafluoroethylene.

**Table 10.4** Range of materials requirements (fuel excluded) for various electricity generation technologies<sup>52</sup>

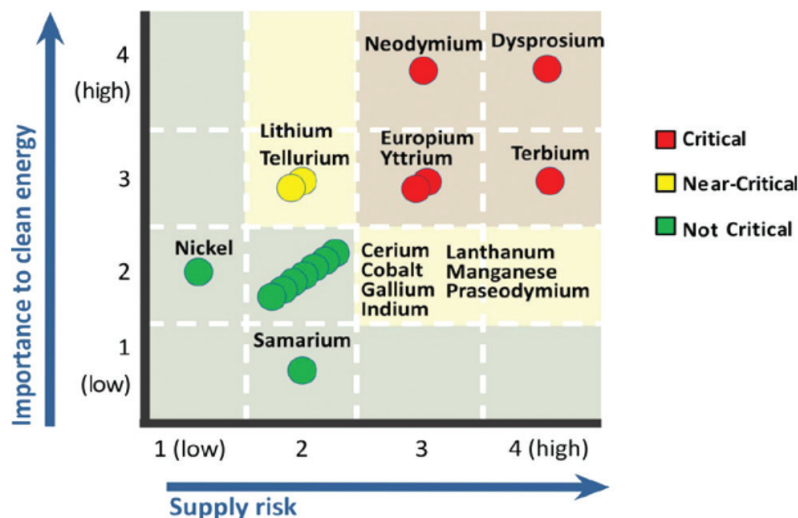
Materials (ton/TWh)	Generator only				Upstream energy collection plus generator			
	Coal	NGCC	Nuclear PWR	Biomass	Hydro	Wind	Solar PV (silicon)	Geothermal HT binary
Aluminum	3	1	0	6	0	35	680	100
Cement	0	0	0	0	0	0	3,700	750
Concrete	870	400	760	760	14,000	8,000	350	1,100
Copper	1	0	3	0	1	23	850	2
Glass	0	0	0	0	0	92	2,700	0
Iron	1	1	5	4	0	120	0	9
Lead	0	0	2	0	0	0	0	0
Plastic	0	0	0	0	0	190	210	0
Silicon	0	0	0	0	0	0	57	0
Steel	310	170	160	310	67	1,800	7,900	3,300

Key: NGCC = natural gas combined cycle; PWR = pressurized water reactor; PV = photovoltaic; HT = high temperature

An important recent concept in the area of materials use is “criticality,” which is classified in terms of importance to the clean energy economy, risk of supply disruption, and time horizon.<sup>49</sup> Critical materials have important magnetic, catalytic, and luminescent properties, with applications in solar PV, wind turbines, electric vehicles and efficient lighting. Five rare earth metals (dysprosium, neodymium, terbium, europium, and yttrium), as well as indium, were assessed as most critical between 2010 and 2015. Four other rare earth elements, as well as gallium, tellurium, cobalt, and lithium, were also considered. Important factors include high demand, limited substitutes, political or regulatory risks in countries where critical materials are produced, lack of diversity in producers, and competing technology demand (e.g., consumer electronics such as mobile

phones, computers, and TVs all use materials that are also essential to clean energy technologies).<sup>50</sup> See Figure 10.4 for an illustration of a variety of these materials in terms of their importance to clean energy technologies versus risk to supply.

While many so-called rare earths are in fact more plentiful than gold and highly dispersed around the world, they are expensive to separate from ore owing in part to how similar their chemical properties are to each other. Recycling, reuse,

**Figure 10.4** Critical Materials in the Medium Term (2015–2025)<sup>56</sup>

and more efficient use of critical materials could significantly lower demand for new materials; currently, only 1% of critical materials are recycled at end of life. Other priorities include diversification of global supplies, environmentally sound extraction and processing, and development of substitutes<sup>53, 54</sup> (see Chapter 9, Section 9.2.2 for DOE RDD&D efforts in critical materials through the Critical Materials Institute). As some technologies could significantly increase or decrease the criticality of certain materials, it is important to include a criticality metric in assessments.

## Reliability and Resilience

The reliability and resilience of the energy system is affected by factors spanning human error, malicious acts, equipment breakdowns, interdependencies with other parts of the energy system, extreme weather and other natural disasters, and more.<sup>54, 55</sup> Many of the technology opportunities discussed in Chapter 3 are geared toward improving the reliability and resilience of the power grid. However, some of the technology opportunities discussed in other chapters can also affect the reliability and resilience of the energy system as a whole. Thus, the potential impact of different RDD&D activities on reliability and resilience across the energy system should be considered.

The most common indicators for electric grid reliability include System Average Interruption Duration Index, System Average Interruption Frequency Index, Customer Average Interruption Duration Index, and Average Service Availability Index.<sup>57</sup> However, these metrics are retrospective in nature and are generally calculated based on data from the previous five years. Furthermore, the calculations will usually not include “major” events that are beyond the control of the electric utility. Finally, the data for different electric utilities and systems are often not comparable due to differences in reporting requirements by different state utility commissions.<sup>58</sup> Other potential metrics are based on probabilistic estimations of system failures such as Loss of Load Probability (LOLP) or Expected Unserved Energy (EUE); however, these metrics relate primarily to the delivery of energy and may not be useful in evaluating the impacts of end-use technology RDD&D activities.

Resilience is more difficult to define, but a framework for developing resilience metrics is laid out by Watson et al. (2014).<sup>59</sup> See Section 10.5.8.

## Other Metrics

While the preceding sections list important metrics for assessing energy technologies, it is not exhaustive. Other significant metrics that might need to be considered include the following:

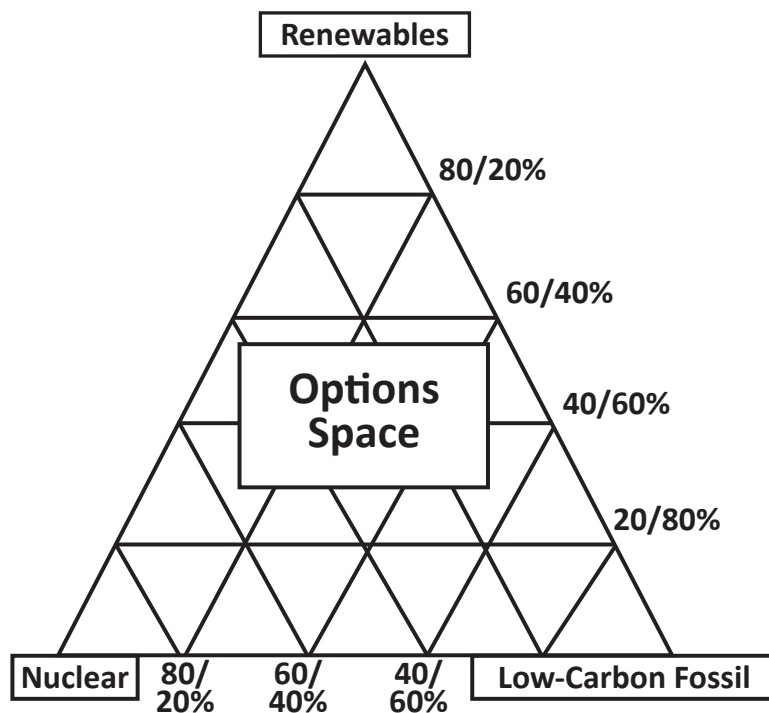
- Social cost of carbon
- Human health impacts
- Supply security and other diversity-related metrics
- Energy imports

## 10.2.4 Evaluation Tools

### Options Space Analysis

The future is highly uncertain. For this reason, it is important to invest in a broad range of technologies. An “options space” is the set of technologies that can contribute to a particular desired service (e.g., power, transportation, thermal comfort) and the characteristics needed of the technologies that will supply this service.

Figure 10.5 presents the electricity sector as an example, which identifies the major technology types for achieving near-zero GHG emissions. For this sector, there are renewables, nuclear power, and “low-carbon” fossil power, e.g., with carbon capture and sequestration (CCS), each of which has several different resources and technologies

**Figure 10.5** Example of Options Space Visualization for the Electricity Sector

between the business-as-usual emissions projection and the desired emissions pathway into “wedges,” each of which represents the phased-in implementation of a significant CO<sub>2</sub> reduction activity over time. A wedge is defined as reducing global CO<sub>2</sub> emissions by one gigaton (that is, one billion metric tons) of carbon (GtC), which is approximately equal to 3.7 gigatons of CO<sub>2</sub> (GtCO<sub>2</sub>) per year after fifty years, or ~92 GtCO<sub>2</sub> in total over that time period.<sup>61, 62</sup> This is shown in Figure 10.6. Pacala and Socolow identified fifteen available technologies, based solely on technical feasibility, which could each deliver one or more wedges. The pathway toward stable atmospheric CO<sub>2</sub> concentrations implies continued emission reductions beyond fifty years.

Since its publication, the wedge concept has entered the scientific vernacular, with researchers downscaling the framework to apply to national or state emissions, emissions within a specific sector, or extending it to other impacts (e.g., human health).<sup>63, 64, 65, 66, 67, 68</sup> The use of wedges to analyze energy portfolios is limited, however, because in most cases multiple technologies cannot be “stacked up” simultaneously in the same system without affecting one another. Moreover, assuming linear penetration of technologies over time is unrealistic and inconsistent with deployment strategies as well as economics. However, wedges provide a convenient way to visualize and approximately rank-order solutions that otherwise differ significantly in technology, impacted sector, or other parameters.

### Integrated Assessment Models

The research community has extensive capabilities in multisystem, multiscale modeling, analysis, advanced computation, and data management. These include internationally recognized strengths in integrated research, modeling, analysis, and assessment of human and physical Earth systems; methods of crosscutting modeling and analysis of system interactions; and observations, data, computation, software, and user interfaces.

Government and private science programs have evolved to explore important and complex scientific questions

that can contribute. Each technology could supply a large share of electricity but probably not all of it; each also carries a different set of advantages and risks. Similar options spaces diagrams have been developed for other sectors.

### Wedge Analysis

Pacala and Socolow (2004)<sup>60</sup> proposed a conceptual framework for assessing climate change mitigation activities that facilitates comparison of different sectors and mitigation options. The framework describes an approach to demonstrate the current technical feasibility of reducing global CO<sub>2</sub> emissions to the degree necessary to stabilize atmospheric concentrations, by dividing the triangular space

at the interface of energy, environment, and the economy that benefit from advanced computational and software capabilities. These programs have pushed the scientific frontiers in both disciplinary and interdisciplinary science. They have also created methods, models, and data tools that can be employed broadly. For example, the capabilities associated with an integrated assessment model (IAM) provide important science-based information used

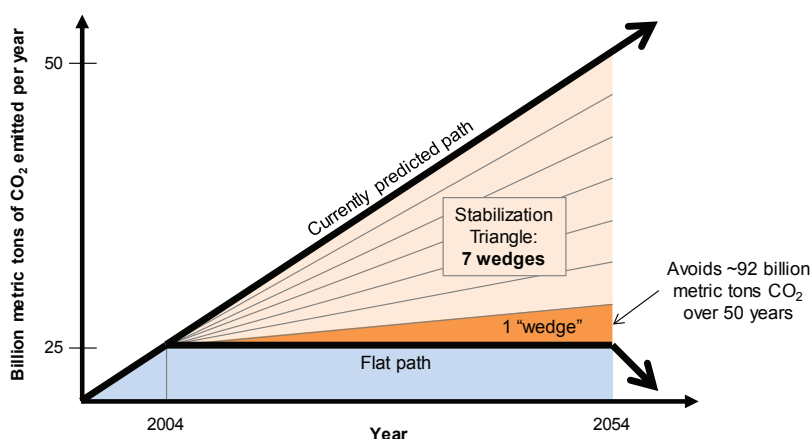
for scientific research. They also are used by government programs for assessing the potential impacts of science and technology advances that benefit the United States and its economy.

IAMs provide a more comprehensive description of the relationship between an energy technology, its competitors and complementary technologies, the larger energy system, and its interactions with the economy, land use, land cover, water, atmospheric composition, and climate. IAMs have been used in the assessment process to provide information about human systems<sup>69,70</sup> and also to assess interactions between human and physical (Earth) systems. IAMs have decade-to-century time horizons and global spatial coverage. Typically, they employ five- to ten-year time steps, and varying regional disaggregation, but many IAMs identify the United States separately, and some models report sub-national information. For example, the Global Change Assessment Model (GCAM) includes a model branch that disaggregates the United States into fifty states plus the District of Columbia; this same model is moving toward one-year time steps. Longer-term efforts might result in seasonal time steps, a potentially significant advancement for this class of IAM recognizing that many key systems, such as energy, water, and land, exhibit strong seasonal variations. IAMs also vary in the degree of technology detail they include. None include engineering process models, but some include a range of different technology options that distinguish between different types of solar power systems, for example, and the grade of solar resource to which the technology is deployed and whose performance evolves over time.

Two IAM teams have models with global coverage, century time horizons, and significant technology detail: GCAM, developed at the Joint Global Change Research Institute<sup>71,72,73,74</sup> and the Integrated Global Systems Model (IGSM), developed at the Massachusetts Institute of Technology.<sup>75,76,77,78</sup> Because IAMs are comprehensive in scope, they avoid the problem of double counting, and they do not assume that the rest of the global energy system remains unchanged as a new energy technology evolves and deploys. IAMs pick up secondary effects, such as indirect land-use change emissions for some bioenergy technologies; international trade effects, which occur, for example, when the technology for producing natural gas is enhanced; and water and land-use consequences of alternative technology deployment, e.g. expanded use of cooling towers for thermal power plants. A major limitation of global-scale IAMs is their lack of insight into local or near-term phenomena.

A new class of model called the regional integrated assessment model (RIAM) is beginning to emerge.<sup>79</sup> RIAMs differ from global IAMs in that they focus on local and regional phenomena over shorter timescales than IAMs. RIAMs are useful for studying economic circumstances and energy technology, characterized to reflect local circumstances, in the context of infrastructure, local topography, land-use restrictions, local ecology, climate, water, and other natural resources such as wind fields. RIAMs such as PRIMA hold the potential to shed light on local and regional energy technology deployment opportunities and limitations.<sup>80</sup>

**Figure 10.6** Stabilization Wedges Concept<sup>62</sup>



While IAMs and RIAMs are powerful tools for assessing the role of technology in the context of larger regional and global contexts, they are best used in combination with information derived from complementary technology assessment tools.

Modeling, analysis, and data management capabilities should evolve with scientific and technological advancements. Five capability development areas that could benefit from further scientific and technological advancements are as follows:

- Robust projections, analyses, and scenarios at decision-relevant scales
- Characterization of uncertainty and risks
- Modeling and analysis of extreme events
- Interoperable modeling, data, and analysis platforms
- Confronting models with observations and using observations to improve projections

Each of these is discussed in more detail below.

**Robust projections, analyses, and scenarios at decision-relevant scales:** Decision makers need robust projections, analysis, and scenarios at decision-relevant scales. This means expanding the scope of models of human systems to include energy, water, land, the economy, and interactions with physical Earth systems that capture weather, climate, and extreme events. All of these systems interact with the others. Land is critical to successful deployment of bioenergy. Water is critical to cooling thermal power plants, producing hydroelectric power, and supporting bioenergy crops. To understand the complex interactions among these systems and provide the variety of information needed to support decisions that range from national and global scales to regional and local scales requires a suite of models. For example, improved Earth system models (ESMs) with finer spatial and temporal resolutions, and added complexity, are enabled by the progress of scientific knowledge and the availability of advanced computing capabilities and software. RIAMs provide high-resolution information about physical and human systems, including the landscape, climate, hydrology, infrastructure, and energy systems. Improved capabilities to assess impacts, adaptation, and vulnerability of energy and other human systems are needed as well as improved information transfer across disciplinary communities. Modular systems with interoperable component capabilities will help facilitate examination of a wider range of science and decision problems. The scope of the next generation of models will be broader, explicitly representing energy systems in greater technical detail, but they will also capture the interaction of the energy system with hydrologic systems, the landscape, carbon cycle, ecosystems, critical infrastructure, urban systems, atmospheric chemistry, weather, climate, and extreme events. Advancements in software and hardware technologies such as next generation supercomputers and software tools should enable more capable models with better representation of complex human-Earth systems.

**Characterization of uncertainty and risks:** Effectively characterizing uncertainty requires a suite of models that include state-of-the-art representation of key processes such as ESMs, RIAMs, reduced-form Earth system emulators, and long-term, global IAMs with energy, economy, water, land, and climate interactions. Models will need to be exercised in coordinated programs that transfer information between them and utilize each modeling system to highlight different aspects of uncertainty. Because human systems both shape physical Earth systems in which they are placed, and are shaped by those same physical Earth system processes, uncertainty characterizations should include socio-economic drivers of change. Analytical tools employed by researchers are unlikely to communicate well to a broader community. Additional work is needed to transform research into usable knowledge. Research is needed on the problem of communicating risk and uncertainty findings beyond the narrow communities in which they were derived. The resulting techniques for developing and communicating risk and uncertainty will provide insights that can help inform and guide investments in energy technology, leading to more robust RDD&D strategies.

**Modeling and analysis of extreme events:** Extreme events occur on short timescales, but can have long-term consequences. Storms and other disruptions can directly affect energy and other infrastructure. Modeling and data management tools have not generally been available to address problems that require high-fidelity representation of extreme events. Research could focus on developing higher resolution ESMs, global and regional IAM capabilities, and associated data management capabilities. Detailed examination of explicit hypothetical events can help identify system vulnerabilities and thresholds. Retrospective analysis to test new model capabilities against observations can help guide capability development.

**Interoperable modeling, data, and analysis platforms:** Scientific and applied questions have evolved to require increasingly sophisticated models, analysis, and data management tools capable of operating across highly-varied scales in time, space, and technical detail. Since it is the problem that determines the appropriate data, tools, and approach, an increasingly varied problem set is best addressed with a tool set that is designed from the beginning to be interoperable. Platforms are needed that can operate at relatively coarser resolution when large ensembles are needed to explore risk and uncertainty, yet which can be reconfigured with different modules to explore fine spatial, temporal, and technical issues. New community-based platforms could facilitate cross-discipline, cross-agency, and cross-model collaborations to address specific science and applied problems. New platforms should be able to employ specialized modeling tools for one problem, but lower-resolution emulators for other problems. For example, the Hector model,<sup>81</sup> a newly developed carbon-cycle and climate emulator, was designed as a modular, open-source, community modeling platform, to facilitate use with a wide range of alternative component modules to address a wider range of applications.

Advanced, high-performance computing enables the development of models that push the frontiers of science. This capability benefits next-generation ESMs and facilitates large ensemble calculations that provide heretofore unavailable opportunities to explore risk and uncertainty. To complement this “leadership class” computing, new visualization tools and analysis software could accelerate data analysis and model diagnostics. New software and tools could take full advantage of leadership class computing, including flexible architectures, advanced adaptive mesh gridding for scale-aware simulations—which offer the ability to deliver very high resolution for local scales—coupled hydrology, subsurface transport, and land-use and land-cover modeling.

**Confronting models with observations and using observations to improve projections:** Models are conditional descriptions of the major features governing phenomena. Their usefulness is contingent on the accuracy with which the relationships in the model are described, the particular phenomena of interest, and the range over which external factors have varied in the past and could vary in the future. Models need to be both anchored to observations and tested against data and observations. Models and tests can be used to describe the limits of model application and point to additional model and data needs. Open model documentation, standards, and applications can accelerate the rate of improvement of models and point to new data requirements.

### Science of Human Decision Making

To accelerate adoption of clean energy technologies, RDD&D should address not only the technologies themselves, but also their design, adoption, and use. These additional requirements point to the intersection of technology, behavior, and decision science. In other words, decisions along the supply chain deserve as much attention and research as those of final energy consumers. Estimates of the energy-saving potential from human decision making in the residential building and personal transportation sectors range from five to nine quads.<sup>82</sup>

<sup>83, 84</sup> Estimates of impacts in other sectors do not yet exist.

Previous researchers have used evidence-based social science to develop principles that impact the design, selection, and use of new clean energy technologies. These principles go beyond providing information to customers and focus on directly engaging energy users, understanding the context of decisions, leveraging technology for greater user control, understanding and navigating social networks, using strategic rewards to increase participation, and raising the profile of energy. Moreover, in addition to evaluation, social science research can play a key role prior to technology deployment by identifying solutions that will be more acceptable to affected groups.

Social science research has traditionally focused on consumers and less on suppliers and providers. The widespread adoption of clean energy technologies could be facilitated by RDD&D employing social and decision science insights in ways that address the problems of siting new sources of generation, transmission, and use of energy across the diverse sectors of transportation, buildings, and industry (including agriculture, construction, manufacturing, and mining). Examples range from understanding public concerns about siting of energy facilities to corporate decisions regarding the design, manufacture, and sale of efficient products.

### Flexible Decision Making: Real Options Valuation

An extension of more traditional decision tree analysis, “real options” valuation is a strategic investment analysis method that parts ways with conventional financial modeling, which often undervalues investments that may lead to large but uncertain future payoff.<sup>85, 86</sup> Real options valuation considers the full uncertainty in future value and focuses on potential value if projects or technologies are successful. A strategy for using real options valuation is to make iterative follow-on investment decisions that do not require large outlays of funding at early stages, providing time to reduce the uncertainty in future value and hopefully improve prospects for success. Options are contingent decisions to invest depending on how events unfold.<sup>87</sup> Options are not free and must be created early to preserve flexibility; once it is clear that they will not be beneficial, however, they can be dropped.

## 10.3. Application of Metrics and Tools for Technology Analysis

As stated earlier in this chapter, multiple metrics must be considered when making prioritization decisions for investing in energy RDD&D. This can be seen clearly in discussion of LCOE. While useful to compare relative economics for technologies delivering a similar service, it can be misleading when comparing technologies that have different operating characteristics or are at different points along a deployment curve. Thus, even within the economic dimension, multiple metrics are needed to fully characterize the trade-offs among competing technologies or technology portfolios, and many of these metrics have not yet been identified. And beyond economics, numerous metrics expressing aspects of national security and the environment are also necessary to assess impacts along these dimensions. Other challenges include the need to consider how the values of metrics will change over time as technologies and the systems in which they are embedded evolve.

When one looks across sectors, the challenge of finding appropriate metrics becomes greater. One cannot, for instance, use the same metric to compare energy generation and vehicle technologies, because energy generation technologies are often expressed by LCOE (in \$/kWh), while vehicle technologies are typically characterized by the levelized cost of driving (LCOD, in \$/km). Similar incompatibilities exist for the other sectors under consideration. At the system level, however, it may be possible to choose simpler metrics; for instance, one could look at the full per capita cost of providing a suite of energy services across all end uses (food, shelter, mobility, health, entertainment, etc.) to a given level of quality for different energy portfolios. Similarly, per capita GHG emissions, water consumption, land use, etc., could be and have been developed (for instance, ecological footprint or per capita societal energy consumption). Nonetheless, assumptions and value judgments are still unavoidable for such high-level metrics.



Identifying the right portfolio involves four interlinked steps:

- Estimating technological improvements (in terms of cost or performance) for a given RDD&D activity, both on a stand-alone basis and as part of a broader technology portfolio
- Estimating the future system-based impacts of an RDD&D portfolio across multiple metrics, relative to a baseline without investment
- Repeating the process for multiple portfolios and comparing the impacts across multiple metrics
- Selecting the portfolio with the largest positive impact

The above-mentioned metrics must then be expressed in a ratio to dollars of RDD&D spending, in order to assess the relative benefit of different investments. Much work remains to identify, characterize, test, and refine these metrics.

Such estimates must account for the inherent uncertainty in current knowledge as well as forecasted change. As noted earlier, evaluation must also be done within an evolving context of economic, political, institutional, and social forces that contain much uncertainty themselves. It is critical that a wide range of possible outcomes be considered, in order to evaluate the robustness of technologies and portfolios.

This section ends with four examples of portfolio decision-making processes in use in different organizational contexts, spanning corporate (General Electric Research), nonprofit (Electric Power Research Institute), academic (Massachusetts Institute of Technology), and government (DOE Building Technologies Office) organizations. While each type of organization may prioritize investments based on different factors, they all share a similar challenge in having to allocate limited funds across a range of opportunities of varying levels of risk. While not comprehensive, they serve to illustrate the types of approaches currently being pursued.

## General Electric Research

General Electric (GE) Research is a branch of GE that invests in research and development. GE is a large company, with consolidated revenues of \$146 billion in 2013. GE-funded RDD&D expenditures totaled \$4.75 billion, with an additional \$711 million coming from customers (principally the U.S. government). GE has spent \$43 billion on RDD&D over the past ten years.<sup>88</sup>

About 60% of funding comes directly from GE businesses, where they together determine the long-range RDD&D needed to support new product introduction strategies. Products are based on marketing analysis and customer feedback. Of note, businesses seldom receive any type of formal proposal from a researcher, but rather they start down an uncertain path based on prior work and the trust that has been developed through earlier collaborative work. These programs will often change direction several times as knowledge accumulates, but the majority is ultimately successful, with associated product launches.<sup>89</sup>

Roughly 25% of research is funded through GE corporate headquarters, and portfolio selection is different, focusing on very long-range and high-risk but potentially disruptive technologies. Often, there is no GE business to provide a commercial perspective, but GE's internal marketing team and GE Ventures provide guidance, as well as considerable judgment used in making selections. There are lower

but realistic expectations for these projects, with the understanding that far fewer will ultimately become products. Solid oxide fuel cells are one example of a ten-year effort that is just now becoming commercial. A small fraction of this funding is also spent on fundamental science in GE's research areas.<sup>90</sup>

The remaining ~15% of research funding comes from government and customer sources, and GE generally works on projects only when there is good strategic alignment with GE's existing portfolio. This allows pursuit of additional, higher-risk options, or to retire risk more rapidly. This type of funding is also commonly used in technical demonstration projects.<sup>91</sup>

## Electric Power Research Institute

The Electric Power Research Institute (EPRI) conducts research, development, and demonstration relating to the generation, delivery, and use of electricity for the benefit of the public. An independent, nonprofit organization, it brings together scientists and engineers as well as experts from academia and the industry to help address challenges in electricity. The fundamental research process is collaborative, and is informed by technical experience and advice from a wide array of organizations.

As an input to project identification and selection, EPRI engages in RDD&D planning at several levels.

- EPRI evaluates long-term RDD&D strategy through a combination of roadmapping and other strategic planning exercises. The horizon of these activities is usually three to ten years, and EPRI typically engages several different organizations in these processes. Consequently, at any given time, EPRI maintains an internal set of roadmaps and other strategic planning documents, typically organized around key long-term issues, which capture the results of its ongoing strategic planning activities.
- There is an annual process of evaluating past and ongoing RDD&D, and identifying and prioritizing new RDD&D projects for the upcoming year. Each research sector (Nuclear, Generation, Power Delivery and Utilization, and Environment) conducts this process in their area. Each RDD&D program has an advisory committee formed of external technical experts from funders, other research organizations, and so on. This annual process is informed by the strategic planning processes described above, and is outlined in greater detail below.
- Each research sector also runs a large number of technical workshops, conferences, and standing technical meetings that are an important source of insights related to key RDD&D priorities.
- EPRI also allocates 10%–12% of all funding to its Technology Innovation (TI) program, which operates independently to identify and pursue emergent research ideas. EPRI staff work with EPRI management to identify and propose potential projects. Typically, TI projects are envisioned to lead to inclusion of new RDD&D content in existing or new RDD&D programs. EPRI senior management reviews and approves TI projects.

The EPRI technical staff (RDD&D management, program managers, etc.) is responsible for final selection of projects and deliverables, based upon their integration of input from the planning activities described above. This integration is a highly collaborative process and involves substantial communication and iteration with advisors on an ongoing basis. The underlying philosophy is to maintain a flexible RDD&D portfolio that can be modified in response to changing priorities relatively quickly.<sup>92</sup>

## Massachusetts Institute of Technology

The Massachusetts Institute of Technology (MIT) is a premier U.S. research institution located in Cambridge, Massachusetts. The MIT Energy Initiative (MITEI) Seed Fund is an annual research grant competition open to all MIT faculty and research staff with principal investigator status (approximately 3,000 people in total). Typically, sixty to seventy proposals are submitted each year for \$150,000 grants of up to two years in duration. Approximately twelve projects are funded each year, with an emphasis on high-risk/high-reward ideas. Projects are voted on by a committee composed of senior MIT faculty, and high-ranking representatives (Chief Technology Officer, or equivalent) of MITEI Founding and Sustaining Member companies. The MITEI website has a full description of the MITEI member program.<sup>93</sup> These companies fund the competition on an equal basis (\$100,000 per member) and have an equal voice in the consensus-driven selection process. MIT typically supplements the fund modestly with philanthropic contributions, and participating faculty also weigh in. Selection is therefore inherently strongly influenced by both industrial and academic perspectives and experience. Importantly, because members have no right to the intellectual property that may be produced, selection is free of parochial interest and is much more directed by broad societal benefit.

While the size and number of Seed Fund awards are comparatively small, generally amounting to a small fraction of total member-supported research at MIT, the prestige attached to the awards, along with their influence, is high. This is, in-part, an outcome of the highly visible and competitive nature of the program, but it is also a reflection of the rare opportunity the awards provide for researchers to pursue speculative ideas, often outside their established fields. Unsurprisingly, the creation of the Seed Fund has been accompanied by a rapid increase in the scale and variety of energy-related research at MIT, with many researchers participating from outside disciplines that are traditionally energy-related. Approximately \$16 million has been awarded to 129 early-stage research projects since 2006.<sup>94</sup>

### 10.4 Cross-sector Synthesis for Portfolio Analysis

The goal of portfolio analysis is to provide key data and analysis for leaders as they make decisions about the RDD&D portfolio on a spectrum of different scales, from allocating individual project funding to U.S.-wide energy considerations, and along different time horizons ranging from near-term (less than five years) to long-term (more than fifteen years). Such decisions offer alternative pathways to improve specific technologies or technology components, as well as develop promising new technologies that currently exist only as research concepts.

Portfolio analysis happens at varying levels of thoroughness, analytic rigor, and transparency. Many institutions engage in portfolio analysis and decision making, using a variety of approaches. The central question that portfolio analysis needs to address is how best to prioritize funding allocations for its RDD&D portfolio. As stated earlier, this chapter does not provide answers to this question, but it indicates approaches that could improve the evaluation of RDD&D investments.

Among the many challenges in making prioritization decisions are data and tool limitations, some of which could be inherent and thus, not easily mitigated. The data needed to calculate multiple relevant metrics are not always available or easily obtainable. Forward-looking projections, for example, often involve estimating data that is highly uncertain, making it a dynamic problem that values flexibility to make investment decisions as conditions change.

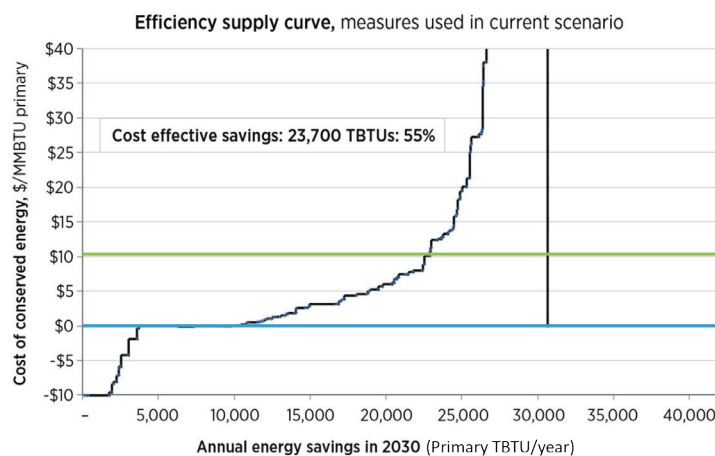
## DOE Building Technologies Office

The Building Technologies Office (BTO) within DOE developed a prioritization tool (P-Tool) that calculates multiple output metrics to set RDD&D priorities for a range of energy efficient technologies. One metric is the cost of conserved energy (CCE), expressed in dollars per million British thermal units (\$/MMBtu). The CCE is defined as the ratio of the net present value of incremental capital cost (including installation) of the new, more efficient equipment, divided by the primary energy savings over the equipment lifetime. Both the numerator and denominator of this calculation are relative to baseline technology cost and energy consumption, and therefore, CCE can be sensitive to the choice of baseline. Figure 10.7 shows example CCE model estimates for all building technologies, represented as a supply curve for 2030.<sup>95</sup> The CCE may be used to determine the cost effectiveness of a measure by comparing its value with the cost of the energy the measure saves; accordingly, the energy cost is not included in the CCE calculation itself.

Aside from CCE, the other calculated metrics are 1) technical potential primary energy savings (i.e., the maximum possible energy savings if all units were immediately replaced with the more efficient technology), and 2) the maximum adoption potential primary energy savings (i.e., the energy savings realized if units were replaced with the more efficient technology as they reach the end of their normal lifetimes, as well as all new units). The P-Tool is used by BTO to help make RDD&D investment decisions across the programs they administer. For example, analysis by the P-Tool suggested that energy savings realizable from solar water heating systems are generally not cost-competitive with energy savings that can be obtained from electric heat pump water heaters, and thus, R&D in solar water heating has been de-emphasized.

Possible future improvements to the P-Tool include: 1) addition of uncertainty to key variables (capital cost, performance enhancement, equipment life, and discount rate); 2) addition of new metrics including GHG emissions (converted to dollars via the social cost of carbon [SCC] metric), health,

**Figure 10.7** Efficiency Supply Curve for Baseline Assumptions in 2030 for Selected Building Technologies<sup>96</sup>



Key: TBTU = trillion British thermal units.

comfort, productivity, benefit to infrastructure, etc.; 3) regional performance estimates based on detailed building simulations in different climates; and 4) more realistic estimates of measure improvements in the context of interactions with other building systems (e.g., lighting and heating, ventilation, and air conditioning) or in bundled measures commonly implemented together (e.g., high-efficiency windows and efficient heat pump).

To perform more relevant and transparent portfolio analysis, one must move more towards an “opportunity” analysis of research pathways and couple these results with a stochastic, integrated energy-economic model of the economy that includes an acknowledgment of the social, economic, institutional, and political context that is also inherently uncertain. Portfolio comparisons need to be based on an “apples to apples” approach using the same methodologies, metrics, and assumptions. It must also make its many assumptions transparent, and perhaps make the models it uses available for public use and scrutiny.

This process begins with technology planning and projection tools (e.g., technology roadmaps, expert elicitation, etc.) to assess the likely improvement in technology cost and performance with a certain level of RDD&D investment. The next step is using quantitative assessment tools to estimate impacts across several relevant metrics.

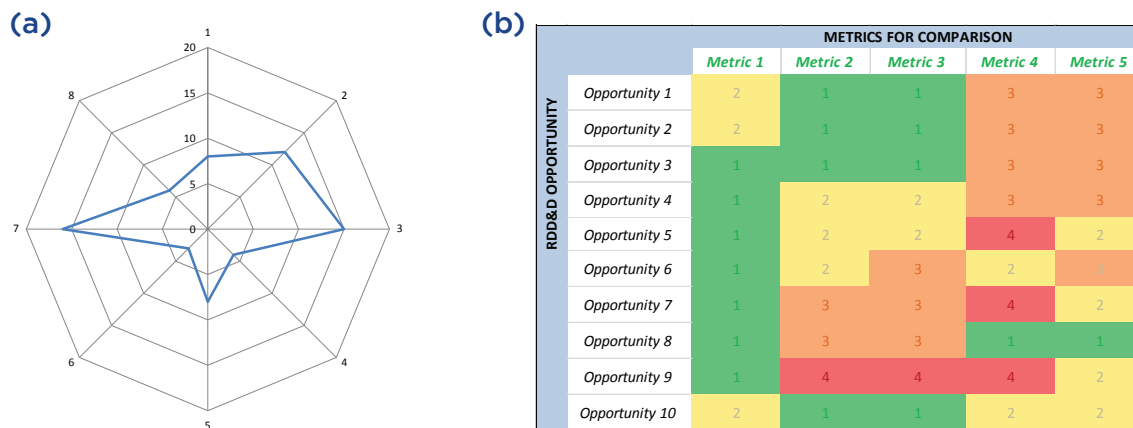
From here, evaluation tools such as IAMs, options space analysis, wedge analysis, and real options valuation are applied, set in a probabilistic context where many options must be considered. Such information will provide decision makers with what they consider most relevant: relationships between choices and outcomes, weighted by risk. Complicating the picture is the fact that technologies do not exist in a vacuum, but they often interact with each other. For instance, an IAM study<sup>97</sup> systematically examined the contribution of performance improvements in a range of technologies—individually and in combination—for reducing the cost of limiting climate change to 2°C. They found that a portfolio of technologies was most effective as it provided mechanisms for reducing emissions across a spectrum of energy uses. Thus, entire portfolios, and not simply individual technologies, must be considered when evaluating impacts.

The final set of RDD&D investment decisions should be made by a diverse set of decision makers to ensure there are no personal stakes in particular outcomes. It is tempting to weight metrics in order to combine them together into a single composite metric that can be rank-ordered. Often people use cost as a weighting factor, “monetizing” other metrics using established relationships such as the social cost of carbon or the value of a statistical human life. However, such approaches are fraught with difficulties, because different people will value such weightings differently, so no such decision can ever be “optimized” in an absolute sense. The use of multiple metrics precludes a true optimization, as it is impossible to maximize multiple objective functions simultaneously, unless they are all linearly related to one another and governed by a single underlying function. Moreover, many assumptions such as time horizon, discount rate, future fuel prices, future capital cost trajectories, climate sensitivities, etc., can strongly affect the values of metrics.

In practice, the volume of data produced from such an undertaking will be too large to readily digest, and may overwhelm and paralyze decision making; instead, a balance must be found between too little and too much information. Examples include “radar plots” and “stop light” matrices,<sup>98</sup> which are useful to compare the multiple impacts that different RDD&D portfolios may have in a single, compact format. Figure 10.8 shows both a radar plot and a stop light matrix approach for the impacts of displaying multiple metrics associated with generic (unspecified) RDD&D opportunities. They are for illustrative purposes only.

Beyond these examples, “data browsers” or “dashboards” can be used to quickly call up data and plot it in different ways according to the desires of the decision maker. It should include the ability to combine metrics together using user-adjustable weightings. It should also include the ability to “dive deeper” into particular metrics or RDD&D investment combinations—provided the data is present in the database—through a successive disaggregation of data. Providing decision makers with choices of what to focus on may be ideal, but this will require developing a large database of portfolio combinations, input assumptions, contextual scenarios, potential metrics, and weightings, all of which may overwhelm even the most ambitious data management efforts. The ability to quickly rerun model(s) in near-real time in an iterative process to explore the change in impacts if, for instance, the portfolio is rebalanced, may be preferable, but invokes a different set of challenges.

**Figure 10.8** Examples of techniques for displaying multiple metrics simultaneously include (a) radar plot and (b) color-coded stop light matrix.



Both sets of capabilities may in fact be required and will become key enabling tools to develop. Making RDD&D investment decisions is ultimately a “soft science,” but it can be made more objective and transparent through the use of approaches such as those discussed here.

## 10.5 Summary of RDD&D Decision Support Needs

RDD&D decisions must consider a variety of factors in an environment that is inherently uncertain, is highly dynamic, and has substantial risks. This section will first discuss the process of decision making, including the key questions decision makers must face, the issues they must address, and the metrics they must use in weighing their decisions. This is followed by descriptions of work remaining to help improve the tools and understandings that constitute the tool set of the decision makers.

### 10.5.1 Compendium of Issues and Metrics Considered in Energy Decisions

Any organization developing an overall RDD&D portfolio should consider questions such as those in Table 10.5. At the individual system and technology level, questions such as those in Table 10.6 should be considered. Technology RDD&D inevitably faces a variety of dynamic factors, however, as sketched in Table 10.7. This requires frequent re-evaluation of how best to guide RDD&D programs, particularly considering where technologies and markets will potentially be in twenty or more years when technologies in early stage RDD&D today may have progressed to large scale markets. The potential impacts of new technologies and systems can vary significantly across different metrics, including measures of security, economic, and environmental impacts, and also materials use, water use, land use, and others, as indicated in Table 10.8. Finally, the time frame for when a technology can be commercialized (e.g., by 2030) and provide a significant market impact (e.g., by 2050) needs to be considered. The years 2030 and 2050 may seem far away, but they can be challenging for energy technologies due to the long periods required for conducting RDD&D and achieving market impact. Notional time frames for RDD&D are indicated in Table 10.9. These can vary from relatively short periods (e.g., four years) for a commercial technology such as photovoltaics, to longer periods (e.g., ten or more years) for a technology that is large-scale, slow, and expensive to demonstrate and commercialize, and requires significant oversight for public health and safety.

For all the considerations in Tables 10.5 to 10.9, how decision makers weigh these factors varies according to their perspective of the relative importance of different challenges and national goals. These are policy decisions and are not addressed here; the focus here is on identifying approaches to provide decision makers with analytical inputs for their consideration.

**Table 10.5** Portfolio-Level Questions

Issue	Questions	Considerations
Public role	Is the portfolio/system/technology appropriate for and worthy of public investment? Does it potentially provide significant public benefit? What are private sector trajectories and scenarios with and without public support?	Technology RDD&D may be too long term, too high risk, too easily appropriable, or too large an investment. Or it may face a lack of infrastructure or have unpriced externality or other public benefits, etc., that deter private investment.
Investment choice	Where should the next dollar of RDD&D investment go across the portfolio?	RDD&D investment decisions depend on the best public return as well as the overall portfolio balance.
Portfolio balance	How should the RDD&D portfolio be balanced over risk, return, time, technologies, and markets?	Any investment portfolio needs to be balanced across dimensions such as those listed here to improve return and manage risk over a time frame that matters.
Portfolio pathways	What are the best RDD&D pathways to pursue to achieve program/portfolio goals? How much benefit is provided by having multiple pathways and how many pathways are sufficient? How do RDD&D efforts connect to other public supports, such as financial incentives or mandates?	Energy RDD&D may need to pursue multiple pathways to solve a particular technology challenge, such as RDD&D on different chemistries to successfully develop CCS. The challenge is determining how many options are useful and at what point there are substantially diminishing returns.
Investment levels	What is the “right” level of investment in a technology and system?	Insufficient RDD&D investment can drop below a critical mass of researchers for there to be adequate progress; too much investment can lead to diminishing returns.
Robust portfolios	How does one ensure that the portfolio is robust? Is this picking winners?	A robust portfolio requires careful development and sufficient resources. They are formed from competing RDD&D options to improve the likelihood of success within a balanced portfolio, avoiding putting “all the eggs in one basket” of so-called winners. Portfolios are the antithesis of picking winners.

**Table 10.6** Representative Criteria and Decision Questions for Systems/Technologies

Factor	Issues and questions
Security impacts	Will the system/technology reduce vulnerability to energy shocks towards zero? Will the system/technology raise reliability and resiliency to high levels?
Economic impacts	Is there a pathway for the system/technology to supply/save energy at market prices? How big is the market the system/technology could potentially address?
Environmental impacts	Will the system/technology significantly reduce criteria pollutants or air toxics? Will the system/technology reduce direct GHG emissions to near zero? Is there a transition path?
Performance requirements	Will the system/technology have additional requirements, such as for grid integration, energy storage, or others, for the system to function appropriately?
Risk	Will the system/technology face risks—technical, managerial, financial, scale-up, regulatory, institutional, business model, political—that may delay or end its large-scale use?
Time frame	Will the system/technology RDD&D impact its markets in a time frame that matters? What is the full value that the technology or system provides, including security, economic, environmental, and other factors?
Public role	Are there appropriate public roles in RDD&D for this system/technology?

**Table 10.7** Representative Dynamic Factors Impacting Technology RDD&D and Questions

Factor	Issues and questions
Time frame for impact	<ul style="list-style-type: none"> <li>■ A technology early to market can get costs down the learning curve, build a supporting infrastructure, and potentially lock in market advantage. A technology slow to market will have more difficulty overcoming incumbents, and will take longer to offset installation of old technology, thus increasing inertia in old systems. What is the time frame to penetrate the market for the technology versus its competitors?</li> <li>■ A technology may provide near-term advantages, but then lock in factors, such as imported fuel use or environmental impacts, that are undesirable in the long term. How should near-, mid-, and long-term costs and impacts be balanced with long-term requirements?</li> </ul>
RDD&D transitions	<ul style="list-style-type: none"> <li>■ The progress of technologies can be very uneven, with long periods of slow development, followed by breakthroughs that allow rapid advance. How should these factors be taken into account in stage-gate decisions on terminating RDD&amp;D, or exploring alternative pathways?</li> </ul>
Transition costs	<ul style="list-style-type: none"> <li>■ To demonstrate a new technology at scale and then drive costs down the learning curve to competitive levels can require an extended period (years) of cost buydown and cost billions of dollars. There may be very limited high-value market niches to initiate these cost reductions. How can advanced RDD&amp;D accelerate this process and reduce costs? (Policies may be important but are not considered by the QTR.)</li> </ul>
Low demand	<ul style="list-style-type: none"> <li>■ Demand forecasts for energy indicate slow growth in the United States. How can innovative clean energy technologies advance when there are limited market opportunities? What market niches could the technology fill? Are they large enough to drive scale-up and learning curve cost reductions?</li> </ul>
Global markets	<ul style="list-style-type: none"> <li>■ Global clean energy markets are large and growing rapidly. Can U.S. companies remain viable without a significant presence in these markets to capture sufficient scale in production, develop specialized equipment, and earn sufficient returns for supporting high levels of RDD&amp;D? What RDD&amp;D would be appropriate to provide broad foundational support of U.S. companies?</li> </ul>
Risk and uncertainty	<ul style="list-style-type: none"> <li>■ Energy markets are highly volatile, yet generally require long-term, large capital investments. This raises significant challenges for long term RDD&amp;D. How might this be addressed, including by small innovative clean energy companies?</li> <li>■ How should low-risk, high-impact events be addressed?</li> <li>■ Regulatory processes can be long and involved. How can the risks and uncertainties of these processes best be managed while protecting public health and safety?</li> </ul>
Energy portfolio	<ul style="list-style-type: none"> <li>■ The volatility of energy markets, risk and uncertainty of supply, and other challenges for the critical services that energy provides to our economy suggest the importance of diversification in our supply, yet this is a period when there is a pronounced emphasis on low-cost natural gas. How might the value of a diversified energy technology portfolio be evaluated and used to guide RDD&amp;D investments?</li> </ul>
Public-private roles	<ul style="list-style-type: none"> <li>■ What are appropriate public and private roles in RDD&amp;D on a particular system and technology? Where can public investment have the most leverage for public benefit?</li> </ul>



**Table 10.8** Representative Metrics for Evaluating Energy Technology RDD&D

Issue	Metric, per unit energy (UE) or capacity (UC), and issues
Security	<ul style="list-style-type: none"> <li>■ <b>Reliability:</b> For electricity, reliability measures include the System Average Interruption Duration Index, the System Average Interruption Frequency Index, and the Consumer Average Interruption Duration Index.</li> <li>■ <b>Resiliency:</b> Resiliency is more difficult to define. See Section 10.5.8.</li> </ul>
Economy	<ul style="list-style-type: none"> <li>■ <b>Market sales for the technology:</b> \$/year; this can indicate the long-term market opportunity for the technology. The large uncertainties (Table 10.3) suggest wide ranges for estimates.</li> <li>■ <b>Cost of energy supplied or saved:</b> \$/UE; levelized cost of energy (LCOE) is often used, but it ignores the type of service provided and should be considered with great caution, as detailed in Section 10.2.3. Production scale and learning curve (Table 10.3) effects should be considered; security and environmental externalities could be considered as shadow costs, per environmental issue described in next row.</li> <li>■ <b>Cost of capacity:</b> \$/UC; capital costs are highly sensitive to financing structure, which is influenced by market experience with the technology and changes over time. All of these effects need to be considered.</li> <li>■ <b>Energy imports offset:</b> \$ total; this considers the potential of the technology to reduce energy (or technology) imports by using domestic production or efficiency gains. Macroeconomic factors due to import costs can also be considered.</li> </ul>
Environment	<ul style="list-style-type: none"> <li>■ <b>Criteria air pollutant emissions:</b> kg/UE; this includes sulfur oxides (SO<sub>x</sub>), nitrogen oxides (NO<sub>x</sub>), particulate matter (PM), and others, that have regulatory controls limiting emissions, but the remaining emissions still have significant health and other environmental impacts.</li> <li>■ <b>Air toxics emissions:</b> kg/UE; this includes neurotoxins such as mercury and lead, as well as others.</li> <li>■ <b>GHG emissions:</b> tCO<sub>2</sub>e/UE; a social cost of carbon value has been developed and can be considered as a shadow cost.<sup>99</sup></li> <li>■ <b>Water:</b> Pollution of water, reduction in oxygen levels, thermal heating of water, disruptions of waterways and others can be included, with corresponding metrics for each.</li> <li>■ <b>Land:</b> Pollution of land, disruption of land, impacts of induced seismicity, and others can be included with the corresponding metrics for each.</li> <li>■ <b>Health:</b> Air pollution mortality, such as deaths/year, and morbidity, such as days of labor lost/year or hospital visits/year, can be estimated for criteria air pollutants and air toxics emissions, but they require detailed analyses of air pollution transport and fate, and human exposure and dose response data. These data which are too complex for regular application to energy RDD&amp;D portfolio analyses; therefore, direct emissions can be used as proxies, with parameterizations developed for estimating corresponding impacts and costs.</li> </ul>
Water	<ul style="list-style-type: none"> <li>■ <b>Gallons withdrawn gal/UE</b>—per unit energy supplied (or saved); for withdrawals, since most of the water is returned to the environment, the quality of the water returned is also important.</li> <li>■ <b>Gallons consumed gal/UE</b>—per unit energy supplied (or saved); it is important to distinguish withdrawals from consumption. Since consumption is returned to the environment as evaporated water, the quality of this evaporation is not considered; any pollutants with it need to be separately accounted for above.</li> </ul>
Land	<ul style="list-style-type: none"> <li>■ <b>Area involved</b> per unit energy supplied, m<sup>2</sup>/UE; technologies such as wind energy have widely spaced wind turbines and thus a wind “shadow” over large areas, but most of this area is still available for farming, ranching, or other uses. The area involved should not be confused with disrupted land.</li> <li>■ <b>Area disrupted</b> per unit energy supplied, m<sup>2</sup>/UE; disrupted land is not available for other uses. For wind, this includes the wind turbine pad and dedicated access roads. For fossil and nuclear energy, it includes the mined area, transport corridors, refining or power plant areas, and public safety exclusion zones. For solar, this includes areas dedicated to solar plants but does not include rooftop system areas. For biomass, this includes dedicated crop area but not crop areas where the biomass is a waste product; it also includes refinery or power plant areas, etc. Details are discussed in Section 10.5.7.</li> </ul>
Materials	<ul style="list-style-type: none"> <li>■ <b>Materials used:</b> kg/UE; this includes materials such as cement, steel, and copper.</li> <li>■ <b>Critical materials used:</b> kg/UE; this includes critical materials such as neodymium, tellurium, etc.</li> </ul>

**Table 10.9** Notional Times Required for Stages of RDD&D

RDD&D activity	Notional time
Technology R&D	4*–10+ years
Regulatory/siting/other	1–10+
Technology demonstrations (one or more)^	1–10+
Financing (to mobilize capital for a full scale commercial demonstration)	1–5+
Commercial pilot	1–5+
Commercial build-out (Growth at xx%/year, depending on capital stock turnover, etc.)	

\* Publicly supported R&D is generally for earlier stage technology than for private firms, thus having longer times.

^ For large energy systems, multiple demonstrations may be required to sequentially scale up to commercial size.

### 10.5.2 Expert Elicitation

Much additional work is needed to improve and, in particular, reduce the cost of expert elicitation. The science needs greater development (including investment in social science), better understanding of the impact of public RDD&D on private RDD&D, and different forms of RDD&D spending and cooperative agreements on technology outcomes. Also, there is a need for better modeling of technology spillover at the global level, where investment or advancement in one technology has beneficial impacts in others.

### 10.5.3 Experience Curve Analysis

Research could improve our understanding of the predictive drivers behind technological progress (that is, “learning” or “experience”) at a more granular level, and in particular, how RDD&D investments can affect learning rates.

### 10.5.4 Life-Cycle Assessment

Finkbeiner et al. (2014) identified 34 gaps and challenges associated with LCA.<sup>100</sup> Gaps that are particularly relevant to the energy sector include double-counting of renewable energy, modeling the production or consumption mix of the grid, using a consistent approach to account for biogenic carbon flows, and including impacts of improbable events (both positive and negative), particularly when evaluating toxicity. Wender et al. (2014) discuss challenges related specifically to prospective LCA.<sup>101</sup>

### 10.5.5 Complementary Metrics to Levelized Cost of Energy

While the methods of calculating LCOE are well established, complementary metrics could more fully (and fairly) characterize energy technologies, particularly for electricity generation where many characteristics besides cost must be considered when making procurement and dispatch decisions. Research could thoughtfully consider a minimum set of metrics that would adequately describe the pros and cons of each energy technology from a performance perspective.

### 10.5.6 Water Use

There are numerous knowledge research gaps for water use in energy technologies. Unlike GHG emissions, which have global impacts, water impacts are local; therefore, the impacts of water consumption and withdrawal should be assessed at a local or regional level.<sup>102</sup> Although there are established approaches for

assessing eutrophication, ecotoxicity, or ecosystem health,<sup>103, 104</sup> these require inventory flows at the regional or local level, and without this data, it is difficult in practice to implement established impact methodologies. Efforts to address this gap in the near term have been developed through allocation assumptions,<sup>105</sup> but regionalized water inventories are needed in the long term. Although the U.S. Geological Survey (USGS) tracks water withdrawals at the state and county level every five years, it does not currently track water consumption.<sup>106</sup> A specific data gap for electric power includes limited data availability for new or small-scale technologies, as the U.S. Energy Information Administration's *Annual Electric Generator Survey* only requires water use reporting for power plants that are larger than 100 MW.<sup>107</sup> Addressing this could be an initial step in developing regionalized water inventories.

### 10.5.7 Land Use

The studies reviewed in Table 10.2 are binary in that they only count land as used or not used. In many cases, land can be occupied but not used exclusively by its occupier. For example, farming and grazing can still occur around wind turbines. Several studies attempted to limit this effect by only counting the land area actually occupied by the facilities and equipment (rather than the full area bounded by the site).<sup>108, 109</sup> Similarly, nuclear power plants are surrounded by safety exclusion zones beyond the site boundary that are not directly necessary for the production of energy. The land within this zone is useful for wildlife and recreational activities, but its use is limited because no development can occur there due to safety restrictions. A binary metric is ill-equipped to handle such a case. Nor is it helpful with dual-use situations, such as the reservoir behind a hydroelectric facility, which can be heavily utilized for irrigation, recreation, and flood control along with electricity generation.<sup>110</sup>

There are also technology-specific factors to be considered. Extreme parameter combinations, changes in technology, and definitional ambiguity may all contribute to variations in land use estimates. For example, it is not always clear whether “land use” or “land requirements” account for roads, occupied by undeveloped land surrounding generating units, in addition to facilities and other physical infrastructure.

A further complicating factor is time-to-recovery.<sup>111</sup> Use that impacts land so little that it can recover to its previous state in a matter of months or a few years after use ends should not be counted the same as use that delays full recovery for decades or centuries. However, this information cannot be preserved in the binary study metric. Additionally, land used to supply renewable energy, can continue to produce energy in perpetuity whereas land used to produce energy from coal, gas, oil, or nuclear fuels will depend upon resources that are depleted over time, requiring new lands to be opened for resource extraction. Further work is critically needed to determine appropriate land-use metrics for meaningful cross-comparisons.

### 10.5.8 Reliability and Resilience

Watson et al. (2014) lay out a framework for developing resilience metrics and designing a Resilience Analysis Process (RAP).<sup>112</sup> While the report focused on the generation, transmission, and distribution of energy (electricity, oil, and natural gas), the framework could be extended to include end-use sectors. A significant effort will be required to implement a robust RAP process. This includes improvements to analytical models to be able to measure the impact of different events with respect to geographical and temporal impacts. Methods also need to be developed to model human interactions with the energy system from both operator and consumer standpoints. Analysis will also be required to translate the model output into economic and social costs.

### 10.5.9 Science of Human Decision Making

Among the challenges for improving decision science research are the following:<sup>113</sup>

- Integration of behavioral, institutional, and technological aspects of decision making
- Rigorous analysis and social science expertise to identify what works in different contexts
- Use of established theory and research design to implement projects including rigorous baselining to allow comparison of results

- Use of standard, robust, and well-defined methods for research, evaluation, validation, and dissemination
- Promotion of an enduring institutional transformation by evaluating outcomes to determine what strategies work best, which should be revised, and which are not effective
- Sponsorship of social science research to build the evidence base for successful decision-making strategies

### 10.5.10 Portfolio Analysis and Prioritization

From the wide variety of potential metrics, organizations need to decide upon a set that will best serve their prioritization objectives and allow for comparisons across technologies, sectors, and portfolios. A sufficiently-detailed model of integrated economy-environment-security systems to represent technology changes arising from RDD&D investments improve evaluation of these metrics, including the ability to rapidly rerun analysis in near-real time with different RDD&D investment distributions, metric weightings, or other inputs. Such evaluations should be done within a robust uncertainty/risk framework to capture a realistic range of outcomes. Finally, visualization tools aid decision makers by allowing them to explore and manipulate the resulting multidimensional metrics.

Many tools, while they exist, have not yet been combined and tested in the manner suggested here, and an overall candidate approach has yet to be developed. The following process could be considered to aid in this development:

- Evaluation of the effectiveness of different approaches, with follow-up discussions among experts to better understand strengths and weaknesses
- Small-scale experiments with promising approaches and tracking key performance factors ranging from effectiveness to overhead costs
- Development of a research plan going forward to resolve methodological issues and implement an objective portfolio analysis process that can systematically and rigorously develop RDD&D investment options and articulate trade-offs

## Supplemental Information

Additional Information on Concepts in Integrated Analysis

[See online version.]

### Endnotes

- <sup>1</sup> “Idea: Triple Bottom Line.” *The Economist*. November 17, 2009. Available at: <http://www.economist.com/node/14301663>.
- Fiksel, J.; Eason, T.; Frederickson, H. “A Framework for Sustainability Indicators at EPA.” National Risk Management Research Laboratory, Office of Research and Development, U.S. Environmental Protection Agency. EPA/600/R/12. 2012. Available at: <http://www.epa.gov/sustainability/docs/framework-for-sustainability-indicators-at-epa.pdf>.
- <sup>2</sup> Mankins, J. C. “Technology Readiness Levels: A White Paper.” Advanced Concepts Office, Office of Space Access and Technology, National Aeronautics and Space Administration (NASA), April 6, 1995. Accessed February 5, 2015: <http://www.hq.nasa.gov/office/codeq/trl/trl.pdf>.
- <sup>3</sup> Banke, J. “Technology Readiness Levels Demystified.” National Aeronautics and Space Administration (NASA), August 20, 2010. Accessed February 5, 2015: [http://www.nasa.gov/topics/aeronautics/features/trl\\_demystified.html](http://www.nasa.gov/topics/aeronautics/features/trl_demystified.html).
- <sup>4</sup> Department of Defense (DoD), “Technology Readiness Assessment (TRA) Guidance.” Assistant Secretary of Defense for Research and Engineering, April 2011 (revision posted May 13, 2011). Accessed February 5, 2015: <http://www.acq.osd.mil/chieftechologist/publications/docs/TRA2011.pdf>.
- <sup>5</sup> Garcia, M. L.; Bray, O. H. “Fundamentals of Technology Roadmapping.” SAND97-0665. Sandia National Laboratories, April 1997. Accessed December 1, 2014: <http://prod.sandia.gov/techlib/access-control.cgi/1997/970665.pdf>.

- <sup>6</sup> Ziagos, J.; Phillips, B. R.; Boyd, L.; Jelacic, A.; Stillman, G.; Hass, E. "A Technology Roadmap for Strategic Development of Enhanced Geothermal Systems." Thirty-Eighth Workshop on Geothermal Reservoir Engineering. Stanford University, Stanford, California, February 11–13, 2013. SGP-TR-198. Accessed January 9, 2015: [http://www1.eere.energy.gov/geothermal/pdfs/stanford\\_egs\\_technical\\_roadmap2013.pdf](http://www1.eere.energy.gov/geothermal/pdfs/stanford_egs_technical_roadmap2013.pdf).
- <sup>7</sup> Garcia, M. L.; Bray, O. H. "Fundamentals of Technology Roadmapping." SAND97-0665. Sandia National Laboratories, April 1997. Accessed December 1, 2014: <http://prod.sandia.gov/techlib/access-control.cgi/1997/970665.pdf>.
- <sup>8</sup> Ibid.
- <sup>9</sup> Chan, G.; Anadon, L. D.; Chan, M.; Lee, A. "Expert Elicitation of Cost, Performance, and RD&D Budgets for Coal Power with CCS." *Energy Procedia* (4), 2011; pp. 2685–2692. DOI: 10.1016/j.egypro.2011.02.169. Available at: <http://www.sciencedirect.com/science/article/pii/S1876610211003663>.
- <sup>10</sup> Kynn, M. "The 'Heuristics and Biases' Bias in Expert Elicitation." *Journal of the Royal Statistical Society: Series A (Statistics in Society)*, (171:1), January 2008; pp. 239–264. DOI: 10.1111/j.1467-985X.2007.00499.x.
- <sup>11</sup> See, for example, Granger Morgan, M. "Use (and Abuse) of Expert Elicitation in Support of Decision Making for Public Policy." *Proceedings of the National Academy of Sciences*, May 20, 2014, (111:20), pp. 7176–7184.
- <sup>12</sup> See, for example the following:
- Verdolini, E.; Anadon, L. D.; Lu, J.; Nemet, G. F. "The Effects of Expert Selection, Elicitation Design, and R&D Assumptions on Experts' Estimates of the Future Costs of Photovoltaics." *Energy Policy* (80), 2015; pp. 233–243.
  - Baker, E.; Bosetti, V.; Anadon, L. D.; Henrion, M.; Reis, L. A. "Future Costs of Key Low-carbon Energy Technologies: Harmonization and Aggregation of Energy Technology Expert Elicitation Data." *Energy Policy* (80), 2015; pp. 219–232.
  - Curtright, A. E.; Morgan, M. G.; Keith, D. W. "Expert Assessments of Future Photovoltaic Technologies." *Environmental Science and Technology* (42:24), 2008; pp. 9031–9038.
  - Anadon, L. D.; Nemet, G. F.; Verdolini, E. "The Future Costs of Nuclear Power Using Multiple Expert Elicitations: Effects of RD&D and Elicitation Design." *Environmental Research Letters* (8:3), 2013.
  - Anadon, L. D.; Bosetti, V.; Bunn, M.; Catenacci, M.; Lee, A. "Expert Judgments About RD&D and the Future of Nuclear Energy." *Environmental Science and Technology* (46:21), 2012; pp. 11497–11504.
  - Abdulla, A.; Azevedo, I. L.; Morgan, G. "Expert Assessments of the Cost of Light Water Small Modular Reactors." *Proceedings of the National Academy of Sciences* (110:24), 2013; pp. 9686–9691.
- <sup>13</sup> Workshop proceedings. Available at: <http://www.globalchange.umd.edu/events/rd-portfolio-analysis-tools-and-methodologies/>.
- <sup>14</sup> Wright, T. P. "Factors Affecting the Cost of Airplanes." *Journal of the Aeronautical Sciences* (3:4), 1936; pp. 122–128.
- <sup>15</sup> Myhre, G.; Shindell, D.; Bréon, F.-M.; Collins, W.; Fuglestedt, J.; Huang, J.; Koch, D.; Lamarque, J.-F.; Lee, D.; Mendoza, B.; Nakajima, T.; Robock, A.; Stephens, G.; Takemura, T.; Zhang, H. "Anthropogenic and Natural Radiative Forcing." In Stocker, T. F.; Qin, D.; Plattner, G.-K.; Tignor, M.; Allen, S. K.; Boschung, J.; Nauels, A.; Xia, Y.; Bex, V.; Midgley, P. M., eds. *Climate Change 2013: The Physical Science Basis*. Contribution of Working Group I to the Fifth Assessment Report of the Intergovernmental Panel on Climate Change. Cambridge, United Kingdom, New York, NY, USA, Cambridge University Press, 2013. Accessed March 25, 2015: [http://www.ipcc.ch/pdf/assessment-report/ar5/wg1/WG1AR5\\_Chapter08\\_FINAL.pdf](http://www.ipcc.ch/pdf/assessment-report/ar5/wg1/WG1AR5_Chapter08_FINAL.pdf).
- <sup>16</sup> Clark, C. E. "Life Cycle Analysis." Chapter 41 in *Fundamentals of Materials for Energy and Environmental Sustainability*, Cambridge University Press, 2011.
- <sup>17</sup> Skone, T. J. "What Is Life Cycle Interpretation?" *Environ. Prog.* (19), 2000; pp. 92–100.
- <sup>18</sup> See, for example, Sathre, R.; Scown, C. D.; Morrow, W. R., III; Stevens, J. C.; Sharp, I. D.; Ager, J. W.; Walczak, K.; Houle, F. A.; Greenblatt, J. B. "Life-cycle Net Energy Assessment of Large-scale Hydrogen Production via Photo-electrochemical Water Splitting." *Energy and Environmental Science* (7:10), June 16, 2014; pp. 3264–3278. doi:10.1039/C4EE01019A.
- <sup>19</sup> Wender, B. A.; Foley, R. W.; Prado-Lopez, V.; Ravikumar, D.; Eisenberg, D. A.; Hottle, T. A.; Sadowski, J.; Flanagan, W. P.; Fisher, A.; Laurin, L.; Bates, M. E.; Linkov, I.; Seager, T. P.; Fraser, M. P.; Guston, D. H. "Illustrating Anticipatory Life Cycle Assessment for Emerging Photovoltaic Technologies." *Environ. Sci. Technol.* (48:18), 2014; pp. 10531–10538. DOI: 10.1021/es5016923.
- <sup>20</sup> Sathre, R.; Masanet, E. "Prospective Life-cycle Modeling of a Carbon Capture and Storage System Using Metal–Organic Frameworks for CO<sub>2</sub> Capture." *RSC Adv.* (3), 2013; pp. 4964–4975. DOI: 10.1039/C3RA40265G.
- <sup>21</sup> Foster, J.; Wagner, L.; Bratnova, A. "LCOE Models: A Comparison of the Theoretical Frameworks and Key Assumptions." Brisbane, Australia: University of Queensland, 2014. Accessed January 1, 2015: <http://eemg.uq.edu.au/filething/get/137/2014-4.pdf>.
- <sup>22</sup> Joscow, P. L. "Comparing the Costs of Intermittent and Dispatchable Electric Generating Technologies." *The American Economic Review* (101:3), February 2011; pp. 238–241.
- <sup>23</sup> U.S. Energy Information Administration. 2014. "Levelized Cost and Levelized Avoided Cost of New Generation Resources in the Annual Energy Outlook 2014." U.S. Department of Energy. Accessed December 15, 2014: [http://www.eia.gov/forecasts/aeo/electricity\\_generation.cfm](http://www.eia.gov/forecasts/aeo/electricity_generation.cfm).
- <sup>24</sup> Ondraczek, J.; Komendantova, N.; Patt, A. "WACC the Dog: The Effect of Financing Costs on the Levelized Cost of Solar PV Power." *Renewable Energy* (75), 2015; pp. 888–898. doi:10.1016/j.renene.2014.10.053.

- <sup>25</sup> See, for example, negative learning rates observed for gas turbines in the 1980s and 1990s reported in McDonald, A.; Schratzenholzer, L. (2001). "Learning Rates for Energy Technologies." *Energy Policy* (29), 2001; pp. 255–261.
- <sup>26</sup> Myhre, G.; Shindell, D.; Bréon, F.-M.; Collins, W.; Fuglestedt, J.; Huang, J.; Koch, D.; Lamarque, J.-F.; Lee, D.; Mendoza, B.; Nakajima, T.; Robock, A.; Stephens, G.; Takemura, T.; Zhang, H. "Anthropogenic and Natural Radiative Forcing." In Stocker, T. F.; Qin, D.; Plattner, G.-K.; Tignor, M.; Allen, S. K.; Boschung, J.; Nauels, A.; Xia, Y.; Bex, V.; Midgley, P. M., eds. *Climate Change 2013: The Physical Science Basis*. Contribution of Working Group I to the Fifth Assessment Report of the Intergovernmental Panel on Climate Change. Cambridge, United Kingdom, New York, NY, USA, Cambridge University Press, 2013. Accessed March 25, 2015: [http://www.ipcc.ch/pdf/assessment-report/ar5/wg1/WG1AR5\\_Chapter08\\_FINAL.pdf](http://www.ipcc.ch/pdf/assessment-report/ar5/wg1/WG1AR5_Chapter08_FINAL.pdf).
- <sup>27</sup> Ibid.
- <sup>28</sup> Fuglestedt, J.; Berntsen, T.; Godal, O.; Sausen, R.; Shine, K.; Skodvin, T. 2003. "Metrics of Climate Change: Assessing Radiative Forcing and Emission Indices." *Clim. Change* (58), 2003; pp. 267–331.
- <sup>29</sup> Shine, K. 2009. "The Global Warming Potential—The Need for an Interdisciplinary Retrial." *Climate Change* (96), 2009; pp. 467–472.
- <sup>30</sup> A metric ton (or "tonne") is equal to 1,000 kg and is slightly larger than a U.S. (short) ton, equal to 2,000 pounds or 0.9072 metric tons.
- <sup>31</sup> Note that carbon capture and sequestration technologies are absent from this comparison owing to a lack of data; they were not left out intentionally.
- <sup>32</sup> Mai, T., R. Wiser, D. Sandor, G. Brinkman, G. Heath, P. Denholm, D. J. Hostick, N. Darghouth, A. Schlosser, and K. Strzepek. 2012. *Exploration of High-Penetration Renewable Electricity Futures. Vol. 1 of Renewable Electricity Futures Study*, NREL/TP-6A20-52409-1. Golden, CO: National Renewable Energy Laboratory.
- <sup>33</sup> See U.S. Environmental Protection Agency. "What Are the Six Common Air Pollutants?" Updated December 22, 2014. Available at: <http://www.epa.gov/oaqps001/urbanair/>.
- <sup>34</sup> See U.S. Environmental Protection Agency. "Persistent Organic Pollutants: A Global Issue, A Global Response." Updated May 4, 2015. Available at: <http://www2.epa.gov/international-cooperation/persistent-organic-pollutants-global-issue-global-response>.
- <sup>35</sup> See U.S. Environmental Protection Agency. "About Air Toxics." Updated April 9, 2015. Available at: <http://www.epa.gov/airtoxics/allabout.html>; see also U.S. Environmental Protection Agency. Updated August 8, 2013. The original list of hazardous air pollutants as follows: <http://www.epa.gov/ttnatw01/188polls.html>.
- <sup>36</sup> See, for example, U.S. Energy Information Administration. "Annual Energy Outlook 2015." April 14, 2015. Available at: <http://www.eia.gov/forecasts/aeo/>.
- <sup>37</sup> Adapted from Cai, H.; Wang, M.; Elgowainy, A.; Han, J. "Updated Greenhouse Gas and Criteria Air Pollutant Emission Factors of the U.S. Electric Generating Units in 2010." Argonne National Laboratory, 2013. Accessed April 10, 2015: <https://greet.es.anl.gov/files/electricity-13>.
- <sup>38</sup> Cai, H.; Wang, M.; Elgowainy, A.; Han, J. "Updated Greenhouse Gas and Criteria Air Pollutant Emission Factors and Their Probability Distribution Functions for Electric Generating Units." Argonne National Laboratory, 2012. Technical Report: ANL/ESD/12-2.
- <sup>39</sup> Environmental Protection Agency. Air Markets Program Data, 2013. Accessed March 17, 2015: <http://ampd.epa.gov/ampd>.
- <sup>40</sup> Throughput, often referred to as water withdrawal, refers to the water uptake from a source by any given process or activity. Water consumption is the amount withdrawn from a source minus the amount returned to the same withdrawal source (see Bayart et al., 2010, next endnote). Degradation refers to changes in both temperature and quality of the water during use.
- <sup>41</sup> Bayart, J.B.; Bulle, C.; Koehler, A.; Margni, M.; Pfister, S.; Vince, F.; Deschenes, L. "A Framework for Assessing Off-stream Freshwater Use in LCA." *Int. J. Life Cycle Assess.* (15:5), 2010; pp. 439–453.
- <sup>42</sup> King, C. W.; Webber, M. E. "Water Intensity of Transportation." *Environmental Science and Technology* (42), 2008; pp. 7866–7872.
- <sup>43</sup> Thermal loading is the transfer of heat from a power plant or other industrial process to cooling water that is released back to the environment, often with detrimental effects.
- <sup>44</sup> Meldrum, J.; Nettles-Anderson, S.; Heath, G.; Macknick, J. "Life Cycle Water Use for Electricity Generation: A Review and Harmonization of Literature Estimates." *Environ. Res. Lett.* (8), 2013; p. 015031.
- <sup>45</sup> Horner, R. M.; Clark, C. E. "Characterizing Variability and Reducing Uncertainty in Estimates of Solar Land Use Energy Intensity." *Renewable & Sustainable Energy Reviews* (23), 2013; pp. 129–137.
- <sup>46</sup> Mattila, T.; Helin, T.; Antikainen, R. (2012) Land use indicators in life cycle assessment. A case study on beer production. *Int J Life Cycle Assess* 17(3):277–286. doi:10.1007/s11367-011-0353-z.
- <sup>47</sup> The following references were used in constructing Table 10.2:
- Bertani, R. "World Geothermal Power Generation 2001–2005." GRC Bulletin reprint from *Geothermics, the International Journal of Geothermal Research and Its Applications* (34), 2005; pp. 651–690.
  - Brophy, P. 1997. "Environmental Advantages to the Utilization of Geothermal Energy." *Renewable Energy* (10), 1997; pp. 367–377.
  - Denholm, P.; Margolis, R. M. "Land-use Requirement and the Per-capita Solar Footprint for Photovoltaic Generation in the United States." *Energy Policy* (36), 2008; pp. 3531–3543.
  - Denholm, P.; Margolis, R. M. "Impacts of Array Configuration on Land-Use Requirements for Large-Scale Photovoltaic Deployment in the US." NREL Conference Paper NREL/CP-670-42971, May 2008. Available at: <http://www.nrel.gov/docs/fy08osti/42971.pdf>.

- Denholm, P.; Hand, M.; Jackson, M.; Ong, S. (2009). "Land Use Requirements of Modern Wind Power Plants in the United States." NREL Report No. TP-6A2-45834, 2009; 46 pp. Available at: <http://www.nrel.gov/docs/fy09osti/45834.pdf>.
  - Dijkman, T. J.; Benders, R. M. J. "Comparison of Renewable Fuels Based on Their Land Use Using Energy Densities." *Renewable and Sustainable Energy Reviews* (14), 2010; pp. 3148-3155.
  - DiPippo, R. "Geothermal Energy: Electricity Generation and Environmental Impact." *Energy Policy* (19), 1991; pp. 798-807.
  - Evrendilek, F.; Ertekin, C. 2003. "Assessing the Potential of Renewable Energy Sources in Turkey." *Renewable Energy* (28); 2003; pp. 2303-2315.
  - Dones, R.; Zhou, X.; Tian, C. 2003. Chapter 8: "Life Cycle Assessment." *Integrated Assessment of Sustainable Energy Systems in China*. Kluwer Academic Publishers, 2003; pp. 319-444.
  - dos Santos, M. A.; Rosa, L. P.; Sikar, B.; Sikar, E.; dos Santos, E. O. 2006. "Gross Greenhouse Gas Fluxes from Hydro-power Reservoir Compared to Thermo-power Plants." *Energy Policy* (34), 2006; pp. 481-488.
  - Egre, D.; Milewski, J. C. "The Diversity of Hydropower Projects." *Energy Policy* (30), 2002; pp. 1225-1230.
  - Fthenakis, V.; Kim, H. C. "Land Use and Electricity Generation: A Life-cycle Analysis." *Renewable and Sustainable Energy Reviews* (13), 2009; pp. 1465-1474.
  - Gagnon, L.; van de Vate, J. "Greenhouse Gas Emissions from Hydropower. The State of Research in 1996." *Energy Policy* (25), 1997; pp. 7-13.
  - Gagnon, L.; Bélanger, C.; Uchiyama, Y. "Life-cycle Assessment of Electricity Generation Options: The Status of Research in Year 2001." *Energy Policy* (30), 2002.
  - Graebig, M.; Bringezu, S.; Fenner, R. "Comparative Analysis of Environmental Impacts of Maize-biogas and Photovoltaics on a Land Use Basis." *Solar Energy* (84), 2010; pp. 1255-1263.
  - Hanegraaf, M.; Biewinga, E.; van der Bijl, G. "Assessing the Ecological and Economic Sustainability of Energy Crops." *Biomass and Bioenergy* (15), 1998; pp. 345-355.
  - Hirschberg, S.; Dones, R.; Heck, T.; Burgherr, P.; Schenler, W.; Bauer, C. "Sustainability of Electricity Supply Technologies Under German Conditions: A Comparative Evaluation." Paul Sherrer Institute, PSI Bericht Nr. 04-15, 2004.
  - International Atomic Energy Agency. "Sustainable Development and Nuclear Power—Nuclear Power Advantages. No date. Accessed March 11, 2011: <http://www.iaea.org/Publications/Booklets/Development/devnine.html>.
  - International Energy Agency. "Environmental and Health Impacts of Electricity Generation: A Comparison of the Environmental Impacts of Hydropower with Those of Other Generation Technologies." June 2002. Available at: <http://www.ieahydro.org/reports/ST3-020613b.pdf>.
  - Jacobson, M. "Review of Solutions to Global Warming, Air Pollution, and Energy Security." *Energy & Environmental Science* (2), 2009; pp. 148-173.
  - Kikuchi, R. "Adverse Impacts of Wind Power Generation on Collision Behaviour of Birds and Anti-predator Behaviour of Squirrels." *Journal for Nature Conservation* (16), 2007; pp. 44-55.
  - Pimentel, D.; Herz, M.; Glickstein, M.; Zimmerman, M.; Allen, R.; Becker, K.; Evans, J.; Hussain, B.; Sarsfield, R.; Grosfield, A.; Seidel, T. "Renewable Energy: Current and Potential Issues." *Bioscience* (52), 2002; pp. 1111-1120.
  - Ribeiro, F.; da Silva, G. "Life-cycle Inventory for Hydroelectric Generation: A Brazilian Case Study." *Journal of Cleaner Production* (18), 2010; pp. 44-54.
  - Robeck, K.E.; Ballou, S. W.; South, D. W.; Davis, M. J.; Chiu, S. Y.; Baker, J. E.; Dauzvardis, P. A.; Garvey, D. B.; Torpy, M. F. *Land Use and Energy*. Argonne National Laboratory, 1980.
  - Silva, D.; Nakata, T. "Multi-objective Assessment of Rural Electrification in Remote Areas with Poverty Considerations." *Energy Policy* (37), 2009; pp. 3096-3108.
  - Styles, D.; Jones, M. B. "Energy Crops in Ireland: Quantifying the Potential Life-cycle Greenhouse Gas Reductions of Energy-crop Electricity." *Biomass and Bioenergy* (31), 2007; pp. 759-772.
  - Trieb, F.; Langnib, O.; Klaib, H. "Solar Electricity Generation—A Comparative View of Technologies, Costs and Environmental Impact." *Solar Energy* (59), 1997; pp. 89-99.
  - U.S. Department of Energy, Office of Utility Technologies, Energy Efficiency and Renewable Energy, and EPRI (Electric Power Research Institute). "Renewable Energy Technology Characterizations." 1997.
  - U.S. Department of Energy. "How Much Land Will PV Need to Supply Our Electricity?" 2004.
- <sup>48</sup> Argonne National Laboratory. "GREET 1 2014." 2014. Available at: <https://greet.es.anl.gov>.
- <sup>49</sup> U.S. Department of Energy. "US Department of Energy Critical Materials Strategy." 2010. Available at: <http://energy.gov/sites/prod/files/edg/news/documents/criticalmaterialsstrategy.pdf>.
- <sup>50</sup> Matulka, R. "Top 10 Things You Didn't Know About Critical Materials." U.S. Department of Energy, January 18, 2013. Accessed February 21, 2015: <http://energy.gov/articles/top-10-things-you-didn-t-know-about-critical-materials>.
- <sup>51</sup> Argonne National Laboratory. "GREET 2 2014." 2014. Available at: <https://greet.es.anl.gov>.

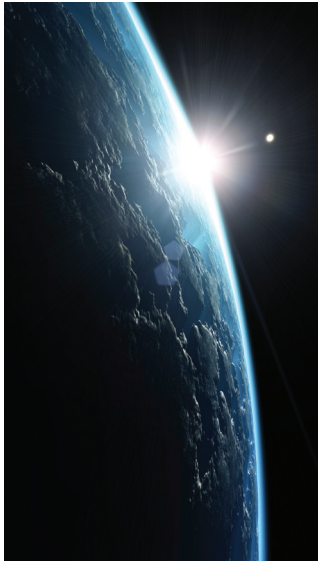
- <sup>52</sup> Ibid.
- <sup>53</sup> U.S. Department of Energy, 2010. *Critical Materials Strategy*, December. <http://energy.gov/sites/prod/files/edg/news/documents/criticalmaterialsstrategy.pdf> (accessed 21 February 2015).
- <sup>54</sup> National Petroleum Council. "Securing Oil and Natural Gas Infrastructures in the New Economy." Washington, DC, 2001.
- <sup>55</sup> Osborn, J; Kawann, C. 2001. "Reliability of the U.S. Electricity System: Recent Trends and Current Issues." LBNL-47043. Berkeley, CA. Lawrence Berkeley National Laboratory, August 2001.
- <sup>56</sup> U.S. Department of Energy, 2010. *Critical Materials Strategy*, December. <http://energy.gov/sites/prod/files/edg/news/documents/criticalmaterialsstrategy.pdf> (accessed 21 February 2015).
- <sup>57</sup> Kucek, J; Kirby, B.; Overhold, P; Markel, L. "Measurement Practices for Reliability and Power Quality: A Toolkit of Reliability Measurement Practices." ORNL/TM-2004/91. Oak Ridge, TN: Oak Ridge National Laboratory, 2004.
- <sup>58</sup> Eto, J, Hamachi LaCommare, K. "Tracking the Reliability of the U.S. Electric Power System: An Assessment of Publicly Available Information Reported to State Public Utility Commissions." LBNL-1092E. Berkeley, CA. Lawrence Berkley National Laboratory, October 2008.
- <sup>59</sup> Watson, J. P.; et al. 2014. "Conceptual Framework for Developing Resilience Metrics for the Electricity, Oil and Gas Sectors in the United States." SAND2014-18019. Albuquerque, NM. Sandia National Laboratories, September 2014.
- <sup>60</sup> Pacala, S.; Socolow, R. "Stabilization Wedges: Solving the Climate Problem for the Next 50 Years with Current Technologies." *Science* (305:5686), 2004; pp. 968-972. DOI: 10.1126/science.1100103. Available at: <http://cmi.princeton.edu/wedges/articles.php>.
- <sup>61</sup> Ibid.
- <sup>62</sup> Socolow, R.; Hotinski, R.; Greenblatt, J. B.; Pacala, S. "Solving the Climate Problem: Technologies Available to Curb CO2 Emissions." *Environment* (46:10), 2004; pp. 8-19. Available at: [http://cmi.princeton.edu/wedges/pdfs/climate\\_problem.pdf](http://cmi.princeton.edu/wedges/pdfs/climate_problem.pdf).
- <sup>63</sup> Lashof, D. A. "U.S. Stabilization Wedges." *Scientific American*, July 27, 2006. Available at: <http://www.scientificamerican.com/article/us-stabilization-wedges/>.
- <sup>64</sup> Mui, S.; Alson, J.; Ellies, B.; Ganss, D. "A Wedge Analysis of the U.S. Transportation Sector." Transportation and Climate Division, Office of Transportation and Air Quality, U.S. Environmental Protection Agency, 2007. EPA420-R-07-007. Available at: <http://www.epa.gov/otaq/climate/420r07007.pdf>.
- <sup>65</sup> Duke, R.; Lashof, D.; Dornbos, B.; Bryk, D.; Greene, N.; Hwang, R.; Lovaa, D.; Mugica, Y.; Spencer, T.; Steelman, J.; Tonachel, L.; Lehner, P. "The New Energy Economy: Putting America on the Path to Solving Global Warming." Natural Resources Defense Council Issue Paper, June 2008. Available at: <http://www.nrdc.org/globalWarming/energy/eeconomy.pdf>.
- <sup>66</sup> Williams, J. H.; DeBenedictis, A.; Ghanadan, R.; Mahone, A.; Moore, J.; Morrow, W. R., III; Price, S.; Torn, M. S. "The Technology Path to Deep Greenhouse Gas Emissions Cuts by 2050: The Pivotal Role of Electricity." *Science* (335), 2012; pp. 53-59. DOI: 10.1126/science.1208365.
- <sup>67</sup> Davis, S. J.; Cao, L.; Caldeira, K.; Hoffert, M. I. 2013. "Rethinking Wedges." *Environmental Research Letters* (8) 011001, 2013; 8 pp. DOI:10.1088/1748-9326/8/1/011001. Available at: [http://iopscience.iop.org/1748-9326/8/1/011001/pdf/1748-9326\\_8\\_1\\_011001.pdf](http://iopscience.iop.org/1748-9326/8/1/011001/pdf/1748-9326_8_1_011001.pdf).
- <sup>68</sup> Balbus, J. M.; Greenblatt, J. B.; Chari, R.; Millstein, D.; Ebi, K. L. 2014. "A Wedge-based Approach to Estimating Health Co-benefits of Climate Change Mitigation Activities in the United States." *Climatic Change* (127: 2), 2014; pp. 199-210. DOI 10.1007/s10584-014-1262-5.
- <sup>69</sup> Clarke, L.; Edmonds, J.; Jacoby, H.; Pitcher, H.; Reilly, J.; Richels, R. "Scenarios of Greenhouse Gas Emissions and Atmospheric Concentrations." Sub-report 2.1a of Synthesis and Assessment Product 2.1. Report by the U.S. Climate Change Science Program and the Subcommittee on Global Change Research. U.S. Government Printing Office, Washington, D.C., 2007; 154 pp.
- <sup>70</sup> Edenhofer, O.; Pichs-Madruga, R.; Sokona, Y.; Farahani, E.; Kadner, S.; Seyboth, K.; Adler, A.; et al. "Climate Change 2014: Mitigation of Climate Change." Working Group III Contribution to the Fifth Assessment Report of the Intergovernmental Panel on Climate Change. Cambridge University Press, Cambridge, United Kingdom and New York, NY, USA 1, 2014.
- <sup>71</sup> Edmonds, J.; Reilly, J. M. *Global Energy: Assessing the Future*. New York: Oxford University Press, 1985.
- Calvin, K.; et al. 2011. "GCAM Main Page." University of Maryland, 2011. Last modified August 21, 2012. Available at: <https://wiki.umd.edu/gcam/>.
- <sup>72</sup> Thomson, A.; et al. "RCP4.5: A Pathway for Stabilization of Radiative Forcing by 2100." *Climatic Change* (109), 2011; pp. 77-94.
- <sup>73</sup> Wise, M. A.; Calvin, K. "GCAM 3.0 Agriculture and Land Use Modeling: Technical Description of Modeling Approach." Richland, WA: Pacific Northwest National Laboratory, 2011. Available at: [https://wiki.umd.edu/gcam/images/8/87/GCAM3AGTechDescript12\\_5\\_11.pdf](https://wiki.umd.edu/gcam/images/8/87/GCAM3AGTechDescript12_5_11.pdf).
- <sup>74</sup> Kim, S. H.; Edmonds, J.; Lurz, J.; Smith, S. J.; Wise, M. "The ObjECTS Framework for Integrated Assessment: Hybrid Modeling of Transportation." *The Energy Journal Special* (Issue 2), 2012; pp. 63-92.
- <sup>75</sup> Prinn, R.; Jacoby, H.; Sokolov, A.; Wang, C.; Xiao, X.; Yang, Z.; Eckaus, R.; Stone, P.; Ellerman, D.; Melillo, J.; Fitzmaurece, J.; Kicklighter, D.; Holian, G.; Liu, Y. "Integrated Global System Model for Climate Policy Assessment: Feedbacks and Sensitivity Studies." *Climatic Change* (41), 1999; pp. 469-546.
- <sup>76</sup> Sokolov, A.; Stone, P. H.; Forest, C. E.; Prinn, R. G.; Sarofim, M. C.; Webster, M.; Paltsev, S.; Schlosser, C. A.; Kicklighter, D.; Dutkiewicz, S.; Reilly, J.; Wang, C.; Felzer, B.; Jacoby, H. D. "Probabilistic Forecast for 21st Century Climate Based on Uncertainties in Emissions (Without Policy) and Climate Parameters." *Journal of Climate* (22:19), 2009; pp. 5175-5204. Available at: <http://dx.doi.org/10.1175/2009JCLI2863.1>.
- <sup>77</sup> Prinn, R.; Paltsev, S.; Sokolov, A.; Sarofim, M.; Reilly, J.; Jacoby, H. "Scenarios with MIT Integrated Global Systems Model: Significant Global Warming Regardless of Different Approaches." *Climatic Change* (104), 2011; pp. 515-537.



- <sup>78</sup> Prinn, R. "Development and Application of Earth System Models." *Proceedings of the National Academy of Sciences* (110), 2013; pp. 3673–3680.
- <sup>79</sup> Hibbard, K. A.; Janetos, A. C. 2013. "The Regional Nature of Global Challenges: A Need and Strategy for Integrated Regional Modeling." *Climatic Change* (118:3–4), 2013; pp. 565–577. DOI: 10.1007/s10584-012-0674-3. Available at: <http://link.springer.com/article/10.1007%2Fs10584-012-0674-3>.
- <sup>80</sup> Kraucunas, I.; Clarke, L.; Dirks, J.; Hathaway, J.; Hejazi, M.; Hibbard, K.; Huang, M.; et al. "Investigating the Nexus of Climate, Energy, Water, and Land at Decision-relevant Scales: The Platform for Regional Integrated Modeling and Analysis (PRIMA)." *Climatic Change*, 2014; pp. 1-16.
- <sup>81</sup> Hartin, C. A.; Patel, P.; Schwarber, A.; Link, R. P.; Bond-Lamberty, B. P. "A Simple Object-oriented and Open Source Model for Scientific and Policy Analyses of the Global Carbon Cycle—Hector v0.1." *Geosci. Model Dev. Discuss.* (7), 2014; pp. 7075-7119. DOI: 10.5194/gmdd-7-7075-2014. Available at: <https://github.com/JGCRI/hector>.
- <sup>82</sup> Gardner, G. T.; Stern, P. C. "The Short List: The Most Effective Actions U.S. Households Can Take to Curb Climate Change." *Environment*, September/October 2008. Available at: <http://www.environmentmagazine.org/archives/back%20issues/september-october%202008/gardner-stern-full.html>.
- <sup>83</sup> Laitner, J. A.; Ehrhardt-Martinez, K.; McKinney, V. "Examining the Scale of the Behaviour Energy Efficiency Continuum, *ECEEE 2009 Summer Study*, 2009; pp. 217-223.
- <sup>84</sup> Dietz, T.; Gardner, G. T.; Gilligan, J.; Stern, P. C.; Vandenberg, M. P. "Household Actions Can Provide a Behavioral Wedge to Rapidly Reduce U.S. Carbon Emissions." *Proceedings of the National Academy of Sciences* (106:44), 2009; pp. 18452-18456.
- <sup>85</sup> Myers, S. C. "Determinants of Corporate Borrowing." *Journal of Financial Economics* (5), 1977; pp. 147-175.
- <sup>86</sup> Amram, M.; Kulatilaka, N. *Real Options: Managing Strategic Investment in an Uncertain World*, Financial Management Association Survey and Synthesis Series, Boston: Harvard Business School Press, 1999. ISBN 0-87584-845-1.
- <sup>87</sup> Ibid.
- <sup>88</sup> General Electric (GE), 2013. "Progress: GE Works: 2013 Annual Report." 2013. Accessed January 9, 2015: [http://www.ge.com/ar2013/pdf/GE\\_AR13.pdf](http://www.ge.com/ar2013/pdf/GE_AR13.pdf).
- <sup>89</sup> Maughan, J. R. GE Research. Personal communication, 2015.
- <sup>90</sup> Ibid.
- <sup>91</sup> Ibid.
- <sup>92</sup> James, R. Electric Power Research Institute. Personal communication, 2015.
- <sup>93</sup> MIT Energy Initiative. "Members." Massachusetts Institute of Technology, 2015. Accessed February 10, 2015: <http://mitei.mit.edu/about/members>.
- <sup>94</sup> Stoner, R. MIT Energy Initiative. Personal communication, 2014.
- <sup>95</sup> Farese, P.; Gelman, R.; Hendron, R. "A Tool to Prioritize Energy Efficiency Investments." National Renewable Energy Laboratory. Technical Report, NREL/TP-6A20-54799, August 2012. Accessed February 4, 2015: <http://www.nrel.gov/docs/fy12osti/54799.pdf>.
- <sup>96</sup> Ibid, Figure 8.
- <sup>97</sup> Edmonds, J.; Smith, S. 2006. "The Technology of Two Degrees." *Avoiding Dangerous Climate Change*. Schellenhuber, H. J.; Cramer, W.; Nakicenovic, N.; Wigley, T.; Yohe, G., eds. Cambridge University Press, 2012; pp. 385-392.
- <sup>98</sup> See examples of stop light matrices in Supporting Information and Anton, P.S.; Ecola, L.; Kallimani, J.G.; Light, T.; Ohlandt, C.J.R.; Osburg, J.; Raman, R.; Grammich, C.A. 2011. *Advancing aeronautics: a decision framework for selecting research agendas*, RAND Corporation, ISBN 978-0-8330-5019-9. [http://www.rand.org/content/dam/rand/pubs/monographs/2011/RAND\\_MG997.pdf](http://www.rand.org/content/dam/rand/pubs/monographs/2011/RAND_MG997.pdf).
- <sup>99</sup> IWGSSC (Interagency Working Group on Social Cost of Carbon), 2010. *Social Cost of Carbon for Regulatory Impact Analysis under Executive Order 12866*, United States Government, February. <http://www.whitehouse.gov/sites/default/files/omb/inforeg/for-agencies/Social-Cost-of-Carbon-for-RIA.pdf>.
- <sup>100</sup> Finkbeiner, M.; Ackermann, R.; Bach, V.; Berger, M.; Brankatschk, G.; Chang, Y.; Grinberg, M.; Lehmann, A.; Martínez-Blanco, J.; Minkov, N.; Neugebauer, S.; Scheumann, R.; Schneider, L.; Wolf, K. "Challenges in Life Cycle Assessment: An Overview of Current Gaps and Research Needs." *Background and Future Prospects in Life Cycle Assessment, LCA Compendium—The Complete World of Life Cycle Assessment*. Springer, Netherlands, 2014.
- <sup>101</sup> Wender, B. A.; Foley, R. W.; Prado-Lopez, V.; Ravikumar, D.; Eisenberg, D. A.; Hottle, T. A.; Sadowski, J.; Flanagan, W. P.; Fisher, A.; Laurin, L.; Bates, M. E.; Linkov, I.; Seager, T. P.; Fraser, M. P.; Guston, D. H. "Illustrating Anticipatory Life Cycle Assessment for Emerging Photovoltaic Technologies." *Environ. Sci. Technol.* (48:18), 2014; pp. 10531–10538. DOI: 10.1021/es5016923.
- <sup>102</sup> Finkbeiner, M.; Ackermann, R.; Bach, V.; Berger, M.; Brankatschk, G.; Chang, Y.; Grinberg, M.; Lehmann, A.; Martínez-Blanco, J.; Minkov, N.; Neugebauer, S.; Scheumann, R.; Schneider, L.; Wolf, K. "Challenges in Life Cycle Assessment: An Overview of Current Gaps and Research Needs." *Background and Future Prospects in Life Cycle Assessment, LCA Compendium—The Complete World of Life Cycle Assessment*. Springer, Netherlands, 2014.
- <sup>103</sup> Guinée, J. B.; Gorree, M.; Heijungs, R.; Huppes, G.; Kleijn, R.; de Koning, A.; van Oers, L.; Wegener Sleswijk, A.; Suh, S.; Udo de, H. H. A.; de Bruijn, H.; van Duin, R.; Huijbregts, M. A. J. *Handbook on Life Cycle Assessment*. Operational guide to the ISO standards. I: LCA in perspective. IIa: Guide. IIb: Operational annex. III: Scientific background. Volume 7. Kluwer Academic Publishers, Dordrecht, The Netherlands, 2002.

- <sup>104</sup> Berger, M.; Finkbeiner, M. (2010) Water Footprinting: How to Address Water Use in Life Cycle Assessment?" *Sustainability* (2), 2010; pp. 919–944. DOI: 10.3390/su2040919.
- <sup>105</sup> Berger, M.; Warsen, J.; Krinke, S; Bach, V.; Finkbeiner, M. (2012) Water footprint of European cars: potential impacts of water consumption along automobile life cycles." *Environ Sci Technol.* 46(7):4091–4099. DOI: 10.1021/es2040043.
- <sup>106</sup> "Summary of Estimated Water Use in the United States in 2010." Fact Sheet 2014-3109. 2014. Available at: <http://pubs.usgs.gov/fs/2014/3109/pdf/fs2014-3109.pdf>.
- <sup>107</sup> U.S. Energy Information Administration. "Annual Electric Generator Survey." February 17, 2015. Accessed April 1, 2015: <http://www.eia.gov/electricity/data/eia860/index.html>.
- <sup>108</sup> Denholm, P.; Hand, M.; Jackson, M.; Ong, S. "Land-Use Requirements of Modern Wind Power Plants in the United States." et al. NREL/TP-6A2-45834, August 2009. Available at: <http://www.nrel.gov/docs/fy09osti/45834.pdf>.
- <sup>109</sup> Brophy, P. "Environmental Advantages to the Utilization of Geothermal Energy." *Renewable Energy* (10), 1997; pp. 367-377.
- <sup>110</sup> Gagnon, L., Bélanger, C., and Uchiyama, Y. 2002. Life-cycle assessment of electricity generation options: The status of research in year 2001, *Energy Policy*, 30: 1267–178.
- <sup>111</sup> International Energy Agency. "Environmental and Health Impacts of Electricity Generation: A Comparison of the Environmental Impacts of Hydropower with Those of Other Generation Technologies." June 2002. Available at: <http://www.ieahydro.org/reports/ST3-020613b.pdf>.
- <sup>112</sup> Watson, J. P.; et al. 2014. "Conceptual Framework for Developing Resilience Metrics for the Electricity, Oil and Gas Sectors in the United States." SAND2014-18019. Albuquerque, NM. Sandia National Laboratories, September 2014.
- <sup>113</sup> Wolfe, A. K.; Malone, E. L.; Heerwagen, J.; Dion, J. "Behavioral Change and Building Performance: Strategies for Significant, Persistent, and Measurable Institutional Change." PNNL-23264, April 2014. Available at: [http://energy.gov/sites/prod/files/2014/06/f16/change\\_performance.pdf](http://energy.gov/sites/prod/files/2014/06/f16/change_performance.pdf).





## Issues and RDD&D Opportunities

- Four overarching themes in energy technology research, development, demonstration, and deployment (RDD&D) are identified:
  - Energy systems convergence
  - Diversification within the energy sectors
  - Energy efficiency everywhere
  - Confluence of computational and empirical capabilities
- Six sets of core opportunities for specific RDD&D activities are presented, organized by the energy sectors represented in the technical chapters of this report:
  - Enabling modernization of electric power systems
  - Advancing clean electric power technologies
  - Increasing efficiency of building systems and technologies
  - Innovating clean energy technologies in advanced manufacturing
  - Advancing systems and technologies to produce cleaner fuels
  - Advancing clean transportation and vehicle systems and technologies
- Twelve crosscutting technology areas are identified:
  - Electric grid modernization
  - Systems integration
  - Cybersecurity
  - Energy-water nexus
  - Subsurface science and technologies
  - Materials
  - Fuel/engine co-optimization
  - Energy storage
  - Computational modeling and simulation
  - Data and analysis
  - Analysis of complex systems
  - Characterization and control of material at multiscales



# Summary and Conclusions

## 11.1 Introduction

To meet our nation's strategic energy objectives of a secure, competitive, and environmentally responsible energy system, broad deployment of a range of advanced energy technologies will be needed. The 2015 Quadrennial Technology Review (QTR) examines the status of various technologies and systems from six core energy sectors as well as the research, development, demonstration, and deployment (RDD&D) opportunities to advance them. More than fifty technology assessments were performed that examined in great depth RDD&D opportunities for those technologies within each sector. The increasing interconnectedness and interdependency among energy sectors necessitated an energy system perspective as the identified RDD&D opportunities were examined.

By approaching these reviews from an energy system perspective, four overarching themes emerged.

The first of these themes is the convergence of energy systems. Virtually all sectors of the energy system are becoming more interdependent. Information and communications technologies, advanced sensors and controls, and market phenomena are enabling the proliferation of advanced technologies that overlap the power generation, electricity transmission and distribution, buildings, manufacturing, fuels, and transportation sectors. Furthermore, energy systems are increasingly coupled to water systems, material flows, waste products, and financial markets. Properly tuned and integrated systems have the potential to improve their overall operations, increase their efficiencies, and enable fundamentally new concepts in the structure of the economy and urban environments. Across all sectors, RDD&D opportunities for understanding, predicting, designing and controlling complex and integrated energy systems were identified.

The second theme is the potential of increased diversification of energy resources, carriers, and uses. The QTR found that many energy sectors in the United States have the opportunity for multiple technology pathways and the potential of increased diversification. This diversification creates challenges to energy infrastructures. In transportation, recent increases in electric vehicle offerings and new developments in fuel cells complement existing alternatives to petroleum such as (natural) gas and biofuels, but complicates refueling infrastructure. In the power generation sector, retiring units are being replaced with a mixture of natural gas, wind, and solar generation, among others, increasing the complexity of electric grid management. Diversification can also be advantageous by giving our energy system resource flexibility and consumer choice. These multiple resource options can potentially have stabilizing effects on the marketplace and enhance energy security.

The third theme is improve efficiency everywhere. Energy efficiency has a long and well-established record of success in reducing energy use, as well as associated factors, such as water use and waste generation. Efficiency improvements can significantly benefit national security, the economy, and the environment, for example, by reducing oil use, business and consumer costs, and environmental emissions, respectively. In the past four decades, energy efficiency together with structural change has increased the energy productivity of the U.S. economy from \$75 billion per quad in 1975 to about \$160 billion per quad today, both in chained 2009 dollars.

RDD&D opportunities to advance cost-effective efficiency technologies abound throughout all energy sectors and systems. The delivery of energy services typically goes through a sequence of energy conversion steps from the initial energy resources to the final delivered energy services, each with associated energy losses. Improving efficiency at any step in the energy services chain can proportionately reduce the energy use and associated losses at each of the upstream steps. Energy efficiency can thus provide high leverage in reducing energy use and cost.

The fourth and final theme is the growing confluence of computational and empirical capabilities that is enabling a new era of “systems by design.” This confluence includes scientific theory, modeling, simulation, high-performance computing, data management and analysis, algorithms, software, and high-throughput experimental techniques to enable the prediction, design, engineering, and experimental characterization of materials and systems from the atomic through the nano-, meso-, and macroscale to manufacturing. These capabilities offer the potential to develop new materials, technologies, and systems more rapidly and at lower cost than traditional approaches. An example is the multiagency Materials Genome Initiative (MGI), launched in 2011, which has the development of such capabilities as its central focus. Federal user facilities and computational facilities as described in Chapter 9 make advanced scientific tools available to energy technology developers.

These themes are found across sectors and throughout the broader energy system. Within this complex “system of systems,” RDD&D opportunities and a set of twelve crosscutting technology areas (see Section 11.8) that are attuned to these themes are essential to achieving the nation’s energy goals. Sector-specific opportunities are summarized in textboxes on subsequent pages.

## 11.2 Enabling Modernization of the Electric Power System

Fundamental changes in both supply and demand technologies are placing new requirements on the electric power system. On the supply side, there is a diversification of resources as aging, low-efficiency capacity is replaced by a mix of central stations and distributed generation, powered by a mix of fossil and renewable resources. On the demand side, diversification includes a rapidly growing use of distributed generation and interactive control systems in buildings, industrial equipment, and consumer goods.

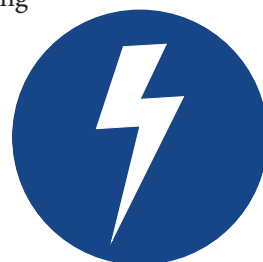
Accompanying these changes is a convergence of digital communications and control systems (“smart grid” technologies) to improve performance and engage consumers. Additionally, grid operations are moving from directing systems with a handful of control points at central stations to ones with potentially millions of highly interactive distributed control points.

These trends create new technical requirements for a grid that is more flexible and agile, with the ability to dynamically optimize grid operations in near-instant time frames. (See textbox: *RDD&D Opportunities for Enabling Modernization of Electric Power Systems.*)

## 11.3 Advancing Clean Electric Power Technologies

The current portfolio of electricity generation technologies is diversifying and improving in efficiency through a combination of reliable, but aging, base-load generation, increasing use of renewable resources, and new generation plants that use the significant domestic natural gas resources.

As the industry evolves to meet growing electrification and greenhouse gas (GHG) emissions reduction goals, challenges arise in optimizing this system, minimizing risks, and maintaining reasonable cost. Progress will consist of advancements in



## RDD&D Opportunities for Enabling Modernization of Electric Power Systems

The modern grid needs enhanced observability, controllability, and interoperability to effectively deal with the burgeoning complexities of generation and end use. Key opportunities include the following:

- Advanced sensing, modeling, and controls to support this transformation
- Development of next-generation materials and component designs for power electronic systems and energy storage

Security, flexibility, agility, and resiliency will be essential outcomes. The design and operation of the electric power system will need to accommodate the shift from a hierarchical, centrally-controlled system to a much more distributed system; from a deterministic system to a more stochastic system; from a system with one-way power flow in distribution to a system with bidirectional flows; from a unidirectional system to a more networked system; and from a system with passive loads to one with numerous interactive and dynamic loads.

Changes in operational characteristics help define the research and development requirements of modern electric power systems, improve performance, lower costs, and address our national energy challenges. RDD&D opportunities include:

- Develop and refine grid architectures and new system designs
- Develop software and visualization tools for enhanced, real-time operations and control of the transmission and distribution grid
- Develop transmission and distribution component designs for higher performance, reliability, and resilience
- Embed intelligence, communication, and control capabilities into distributed energy resources and microgrids to support grid operations
- Improve energy storage and facilitating integration
- Develop power system planning tools
- Design systems to improve physical and cybersecurity of the grid

technologies currently deployed, such as more efficient, fossil-based generation with carbon capture or advanced nuclear reactors; rapidly advancing renewable technologies, including wind and solar energy; and technologies on the horizon, such as fuel cells and marine hydrokinetic power. For details on RDD&D opportunities, see textbox: *RDD&D Opportunities for Advancing Clean and Cost-Competitive Electric Power Technologies*.

### 11.4 Increasing Efficiency of Building Systems and Technologies

Considerable potential exists to reduce building energy usage and improve building energy efficiency. Currently, the major energy end uses in buildings are heating, ventilation, and air conditioning (HVAC); lighting, water heating, and refrigeration; and electronic devices, including computers. HVAC is the most energy intensive, and contributes to GHG emissions both through its consumption of fossil-fuel energy and through the refrigerants used as working fluids. HVAC energy usage can be reduced by decreasing the load or improving the efficiency of HVAC systems. With respect



## RDD&D Opportunities for Advancing Clean and Cost-Competitive Electric Power Technologies

Clean and cost-competitive electric power technologies require both systems-level and technology-level RDD&D. Key systems-level RDD&D opportunities include the following:

- **Materials:** Develop advanced materials with properties that can meet the requirements of extreme conditions, processing techniques to produce them, and qualify them for use
- **Computing:** Develop high-performance computing, advanced algorithms, and control and decision science to improve power generation technologies and operations
- **Data management:** Improve technologies and software for data collection, analysis, and use (while protecting privacy) to strengthen planning and improve power operations
- **Multivariable portfolio analysis for power generation:** Develop well-defined and quantified metrics, modeling, and analytical tools to support an integrated approach to energy diversity
- **Energy-water nexus:** Evaluate system balances, tradeoffs, and sensitivities, and develop analytical tools to assess and optimize energy-water systems
- **Energy storage:** Develop analytical tools to evaluate energy storage options at multiple scales and technologies to integrate them in new power system configurations

RDD&D opportunities in clean electric power technologies include the following:

- **Carbon capture and storage (CCS):** Demonstrate second generation pilots, demonstrate retrofit of existing plants with CCS, demonstrate CCS technologies on industrial and natural gas sources, and develop a database characterizing storage options
- **Nuclear power:** Advance light water reactors, small modular reactors, high-temperature reactors, fast-reactors, fuel cycle technology, and hybrid systems.
- **Hydropower:** Advance materials and turbine designs, with an emphasis on modular systems and systems with reduced footprints
- **Wind power:** Develop integrated multiscale models of atmospheric flow through turbines, models and technologies for grid integration, offshore wind turbine technologies, and scaled up on-shore systems for both low and high wind speed regimes
- **Biopower:** Advance biopower technologies, including biomass gasification and biomass systems coupled with CCS
- **Solar (photovoltaic and concentrating solar power):** Reduce solar PV and CSP manufacturing and capital costs, reduce PV soft costs, improve grid integration—including with storage solutions, and identify and develop new PV materials and devices, particularly with abundant and environmentally-benign materials
- **Geothermal energy:** Improve the characterization of geothermal resources, technologies for controlling fracture networks and improving subsurface access, and advance hybrid systems
- **Fuel cells:** Reduce component and system costs, address gas cleanup, and advance modeling and simulation
- **Marine hydrokinetic power:** Develop advanced controls, design compact generators, and address corrosion and biofouling



to lighting, more than 95% of the potential savings due to advanced solid-state lighting remains unrealized. Continued innovation is still needed. The convergence of information technology and energy systems, and the increasing needs for building systems and technologies to “transact” with the electric utility for demand reduction and other purposes are helping to spur innovations in building energy modeling, sensors, and controls. However, many building technologies are not being widely adopted in the marketplace, largely because of excessive first costs. RDD&D in the buildings sector has to emphasize both cost reductions as well as efficiency improvements. Miscellaneous electric loads, such as small appliances, chargers, and office equipment use an increasing fraction of the typical building’s total energy load. As a result, the best approach will require achieving substantial energy reductions in a wide variety of devices such as with advanced power electronics. See textbox: *RDD&D Opportunities for Increasing the Efficiency of Building Systems and Improving Technologies*, which describes a number of areas where significant advances are possible, with substantial potential benefits.

## RDD&D Opportunities for Increasing the Efficiency of Building Systems and Improving Technologies

Energy efficiency RDD&D opportunities in the buildings sector abound, from improvements in individual technologies to the full building system and its integration with other sectors. These include the following:

### **Building thermal comfort and appliances**

- Develop materials that facilitate deep retrofits of existing buildings (e.g., thin insulating materials)
- Improve low-GWP (global warming potential) heat pump systems
- Improve tools for diagnosing heat flows over the lifetime of a building
- Develop clear metrics for the performance of building shells in heat management and air flows

### **Lighting**

- Develop test procedures for reliably determining the lifetime of light-emitting diodes (LEDs) and organic light-emitting diodes (OLEDs) products
- Understand why LED efficiency decreases at high power densities
- Develop high-efficiency green LEDs
- Develop glazing with tunable optical properties (also needed for thermal load management)
- Develop efficient, durable, low-cost OLEDs

### **Electronics and miscellaneous building energy loads**

- Design more efficient circuitry and more flexible power management
- Standardize communications protocols for managing building systems and integrating them with external systems
- Develop wide bandgap semiconductors for power supplies

### Systems-level opportunities

- Develop energy harvesting systems to provide power for wireless sensors and controls
- Improve the design and cost effectiveness of accurate, reliable sensor and control systems
- Develop algorithms that allow building sensor and control systems to automatically optimize operations across desired factors
- Develop easy-to-use, fast, accurate software tools for design and operations, including open source software
- Improve support for co-simulation with other modeling engines
- Incorporate more decision science research in buildings energy issues such as design and operations while protecting privacy
- Develop components and system designs that allow building devices to share waste heat

## 11.5 Innovating Clean Energy Technologies in Advanced Manufacturing

The manufacturing sector consumes 24 quads of primary energy annually in the United States or about 79% of total industrial energy use. However, the energy impacts are much broader as manufactured goods affect the production, delivery, and use of energy throughout the economy.

Improved efficiencies in manufacturing technologies can drive economy-wide energy impacts at three levels:

- Manufacturing unit operation systems
- Production/facility systems
- Supply-chain systems

There are significant RDD&D opportunities at each of these levels, as described in the textbox: *RDD&D Opportunities for Clean Energy Technologies in Advanced Manufacturing*.



### RDD&D Opportunities for Clean Energy Technologies in Advanced Manufacturing

The systems framework, at the unit operations, facility, and supply-chain levels, outlines ways to improve the energy and emissions footprint of the manufacturing sector. RDD&D opportunities for consideration include the following:

- **Process heating systems:** These systems account for nearly two-thirds of onsite manufacturing energy use; opportunities to reduce energy consumption include lower-energy processing (e.g., microwave heating), integrated systems, and advanced controls.
- **Motor-driven systems:** Motor-driven systems account for more than two-thirds of manufacturing electricity use; key opportunities to reduce energy consumption include

optimized motor system design, greater use of variable frequency drives, wide bandgap semiconductors, and leveraging the latest information technology advances for more intelligent power use.

- **Process intensification:** The integration of multiple unit operations into a single piece of equipment can reduce energy use, waste generation, and environmental impacts.
- **Roll-to-roll processing:** This fabrication technique enables low-cost production of complex-functional, large surface area devices needed for many clean energy applications such as flexible electronics for solar panels and membranes for low-energy separations.
- **Additive manufacturing:** In comparison with conventional subtractive manufacturing techniques, additive (3D printing) techniques can reduce materials waste, eliminate production steps, and enable new products that cannot be fabricated via conventional methods.
- **Combined heat and power:** The concurrent production of electricity and useful thermal energy from a single energy source can reduce fuel requirements compared to generating power and heat separately. Additionally, combined heat and power generation is typically performed onsite, increasing resiliency.
- **Waste heat recovery:** Generated waste heat can be captured and re-used by redirecting waste streams for use in other thermal processes, or by converting the waste heat to electricity.
- **Advanced sensors, controls, platforms, and modeling for manufacturing:** Automation, modeling, and sensing technologies enable real-time and proactive management of energy, productivity, and costs.
- **Industrial demand-side management:** By shifting electricity use away from peak times, demand on the grid can be better managed to match supply, allowing industrial consumers to avoid high rates.
- **Advanced materials manufacturing:** Computational modeling and data exchange could greatly accelerate the process of new materials discovery by minimizing trial and error.
- **Critical materials:** Many clean energy technologies are heavily reliant on critical materials (e.g., neodymium in a wind turbine permanent magnet). More secure and sustainable supply chains will more effectively advance technologies reliant on critical materials.
- **Sustainable manufacturing:** Material flow analyses reveal energy savings opportunities from products designed for re-use, technologies that enable greater use of secondary materials, and technologies that reduce raw materials requirements.
- **Direct thermal energy conversion materials, devices, and systems:** Technologies that convert energy from one form to another without intermediate steps (e.g., thermoelectrics for heat-to-electricity) can be used for waste heat recovery, efficient heating and cooling, and other applications.
- **Materials for harsh service conditions:** Opportunities include higher-temperature, higher-efficiency power plants; corrosion-resistant pipelines; and safer nuclear fuel claddings.
- **Wide bandgap semiconductors:** Wide bandgap semiconductors can enable smaller, lighter, and higher-efficiency power electronics compared to conventional silicon-based devices.
- **Composite materials:** Lightweight, high-strength, and high-stiffness structural composite materials could provide energy and environmental benefits in lightweighting applications such as vehicles, wind turbines, and gas storage.

## 11.6 Advancing Systems and Technologies to Produce Cleaner Fuels

Fuels directly supply 99% of the energy needed by our national transportation system and 66% of the energy needed to generate our electricity. In particular, fossil fuels account for 82% of total energy use in the United States. After several decades of generally flat (natural gas) or declining (oil) production, production of shale gas and oil has sharply increased in the United States in the past half-dozen years. Commercial production of cellulosic biomass fuels is poised to begin in 2015 after many years of research and development. Public-private partnerships are beginning to supply hydrogen to refuel the first commercially available consumer fuel cell electric vehicle.



The tradeoffs between conventional and alternative fuels—including cost, performance, infrastructure, security, and environmental impacts—occur across different time frames. An understanding of the diverse technological options in the fuels sector can support an informed RDD&D strategy going forward (see textbox: *RDD&D Opportunities for Advancing Systems and Technologies to Produce Cleaner Fuels*).

### RDD&D Opportunities for Advancing Systems and Technologies to Produce Cleaner Fuels

The fuels sector—oil and gas, biofuels, hydrogen, and others—has very different levels of maturity and corresponding differences in the types of RDD&D needed and the appropriate public and private roles for each. RDD&D opportunities for consideration include the following:

#### Oil and gas

The economics of oil and gas are well understood. The shale revolution has increased confidence in sustained low natural gas prices, and the increase in domestic petroleum production has softened the impact of a volatile global oil market. The carbon footprint of these fuels, though, is large, and additional environmental concerns must be addressed. Specific technology opportunities include the following:

- Minimize the safety and environmental impacts of unconventional oil and gas development
- Protect groundwater, reduce water use, and protect air quality
- Reduce methane leaks associated with pipelines and compressors
- Develop understanding of induced seismicity
- Develop understanding required for commercial production of natural gas from natural hydrate deposits

#### Bioenergy for fuels

Advanced biofuels have the potential to significantly reduce GHG emissions compared to fossil-derived transportation fuels. There are many options in both feedstock and conversion technologies adaptable to regional resources and market demands. They could potentially supply about 25% of current U.S. transportation fuel demand. Biofuels should be used in sectors most difficult to electrify (such as

aviation, trucking, marine, and other similar applications). However, cost of production is currently high, and production capacity is insufficient to meet market demand. Key technology areas to be addressed include the following:

- Reduce costs of feedstock production, logistics, and conversion
- Produce and manage a consistent suite of lignocellulosic feedstocks
- Improve enzymes and micro-organisms for biochemical pathways and improving catalysts and processes for thermochemical pathways
- Develop high-value bio-products and bio-based inputs to chemicals

### Hydrogen

Hydrogen is a zero-carbon energy carrier that could be produced entirely from domestic energy resources. Some technologies for producing, distributing, and using hydrogen are mature, but the costs of converting the end-to-end fuels infrastructure to accommodate hydrogen are high. Furthermore, hydrogen production from low- or zero-carbon resources is currently not economically competitive. Specific technology areas to be addressed include the following:

- R&D of materials and systems innovations to improve efficiencies, performance, durability, and reduce cost
- Address safety across all hydrogen production, delivery, storage, and dispensing options

## 11.7 Advancing Clean Transportation and Vehicle Systems and Technologies

Transportation provides personal mobility, freight delivery, and other mobile services to individuals and to the economy. It is the primary user of petroleum in the United States and a major emitter of GHGs and EPA-regulated criteria pollutants. Currently, light-, medium-, and heavy-duty vehicles account for approximately three quarters of transportation energy use and emissions. To greatly reduce GHG emissions, a larger share of vehicles must more efficiently use fuels and/or use lower-carbon energy, as it is not currently possible to capture and store carbon dioxide emissions from small, mobile sources. The technology portfolio uses complementary approaches that together shape an integrated research and development strategy for GHG emissions reduction, including component efficiency improvements, electric drivetrains, renewable fuels, and transportation system efficiencies. Efficiency opportunities exist in all modes, and in many cases represent the most cost-effective mechanism to reduce petroleum use and emissions in the near term. For light-duty vehicles, drivetrain electrification is a promising pathway to eliminate mobile source emissions and increase diversity of energy resources. Two of the most promising electrification options are hydrogen fuel cell vehicles and battery electric vehicles, but both still face substantial cost and performance challenges (see textbox: *RDD&D Opportunities in Clean Transportation and Vehicle Systems and Technologies*).



## RDD&D Opportunities in Clean Transportation and Vehicle Systems and Technologies

RDD&D opportunities to improve vehicle efficiency and use clean fuels are described below for conventional and new electric and fuel cell vehicles, from individual components to the systems level. Key opportunities for consideration include the following:

- **Fuel economy** improvement with advanced combustion engines and more energy efficient vehicle systems.
- **Fuel-vehicle co-optimization**, to better use novel low-carbon fuels, achieved through integrated R&D across the fuel-vehicle system.
- **Lightweighting** of vehicles can improve efficiency across all drivetrains and vehicle classes.
- **Electric drivetrain** vehicles are a key strategy to reduce petroleum use and emissions from light duty vehicles. Plug-in electric vehicles, fuel cell electric vehicles, or a mix can offer this benefit.
- **Battery cost, weight, and reliability** improvements, together with power electronics, controls, and system research, can reduce the cost and improve performance of all electrified vehicles.
- **Power electronics, traction motor(s), and controls** research must reduce costs for technologies to be competitive.
- **Fuel cell vehicle** penetration in the light-duty market requires R&D to increase the durability and lower the cost of fuel cells, and lower the cost, volume, and weight of on-board hydrogen storage.
- **Fuel cell systems** should operate at 65% efficiency with an ultimate goal of 70% and be durable for 5,000 hours (equivalent to a vehicle life of about 150,000 miles). The following performance-related barriers need to be addressed: 1) sub-optimal utilization of platinum group metal content in current catalysts, 2) low performance of current catalysts and electrodes, 3) low performance of membranes under the hot and dry conditions, and 4) lack of understanding of the role of electrode composition and microstructure on fuel cell performance and durability.
- **On-board hydrogen storage** should provide a driving range of more than 300 miles at a competitive cost without compromising safety, performance, or interior space.
- **Other transportation modes**—including aviation, marine, rail, and off-road equipment—have significant efficiency improvement potential. These modes are currently a smaller but growing share of total petroleum use and emissions and increasing their efficiency is an area for future research.
- **A systems perspective** on transportation and technologies will enable future investment in smarter transportation systems and technologies. For example, vehicle connectivity and automation is an emerging issue in transportation energy, but initial research is needed to evaluate possible investment pathways.

## 11.8 Crosscutting Opportunities

Many technology themes transcend specific energy sectors. The analyses conducted for this QTR identified twelve technology RDD&D areas that cut across the six sectors. These avenues of research, with co-benefits across multiple sectors, should be pursued in an integrated manner through new research initiatives and/or by facilitating more communication between, and enhanced alignment of, existing activities. Advances in one area can lead to benefits in others.

The identified crosscutting opportunities fall into two categories: 1) technical topics, and 2) enabling tools. Technical topics include the following:

- **Grid modernization:** The electric grid is transitioning from a centrally-controlled, predictable system with one-way power flows in distribution to a much more distributed, stochastic, and dynamic system with bi-directional flows in distribution. Growth in the deployment of variable generation, electronic converters, and digital communications and control technologies is impacting core characteristics of the electricity system. Grid-related technologies need to evolve with the changing supply and end-use technologies landscape. Simultaneously, the RDD&D associated with technologies that connect to the grid (e.g., renewable power supplies, efficient motor controllers, and smart loads) should consider the evolving interface with the grid. If electricity displaces petroleum and natural gas in electric vehicles and heating applications, respectively, the grid may serve an even more central role in the future energy system. The RDD&D opportunities identified for this rapidly evolving sector include planning models, operational tools, transmission components, distribution hardware, control systems, electricity storage and cybersecurity. These opportunities need to be developed in anticipation of an agile, flexible, and resilient electric power system to enable effective integration of variable supplies and participatory demand.
- **Systems integration:** Energy systems are increasingly interconnected to one another and to other systems such as water and materials supply. Potential benefits of integrated systems include efficiency, resource savings, reduced GHG emissions, and increased resiliency. There are also challenges and risks associated with systems integration such as potential bottlenecks and points of failure. Appropriate application of systems integration requires understanding, control, and optimization across multiple sectors, time frames (e.g., fractions of a second for operations to years for planning), spatial scales (devices, buildings, campuses, city, region/state, nation), and functions (e.g., data, analysis, controls, and markets). Integration also requires an understanding of costs, particularly the capital costs of deploying new and/or integrative technologies, as well as the financial implications of deployment and operations. Integration of technologies such as fuel cells, energy storage, rooftop solar, and microgrids will all be affected by systems integration strategies. RDD&D in this area could enable system designers and operators to work toward an optimal level of interconnectedness with risk mitigation through appropriate system sizing and graceful disconnection strategies.
- **Cybersecurity:** The extensive digital technologies that enable significant improvements to new energy systems also increase the attack surface for cyber intrusion. Opportunities to improve cybersecurity are being actively pursued for the energy sector, including electricity generation and oil and gas production, the supervisory control and data acquisition systems for automated controls of building energy use, the information technology-enabled manufacturing space, and connected and automated vehicles. Rigorously applied cybersecurity best practices, tools that measure the security and resilience of energy systems, and networks and systems that adapt to and self-configure in the presence of evolving cyber threats, can help ensure the cyber integrity of components through the entire energy system supply chain.

- **Energy-water:** Water use is intertwined with oil and gas production, growing and processing biomass, cooling thermal power plants, numerous manufacturing processes, and direct use by humans. Conversely, substantial energy is used to withdraw, transport, clean, and condition water and ultimately return it to the environment. Effective RDD&D can improve the efficiency of these processes, or alternately, find cost-effective low/no water alternatives. Opportunities include novel nano-structured membranes, and new chemical and biological-based treatment technologies. There is also broad opportunity to accelerate the development of databases, modeling, and analysis to better understand and address water quality, availability, and fate. Furthermore, water resources are expected to change in location and timing due to climate change impacts; fundamental advances in climate science and integrated assessment could help to better understand these unknowns. The long lifetimes and high costs of installed energy equipment and water infrastructure underpin targeted and effective energy-water R&D in the context of climate change.
- **Subsurface:** Oil and gas production, geothermal energy, carbon capture and storage (CCS), and nuclear waste disposal all rely on effective control and management of the subsurface environment. Foundational scientific research and crosscutting applied technology development can improve characterization and manipulation of subsurface formations for all of these applications. Quantitative prediction and control of subsurface fractures, fluid flow, complex physicochemistry, and rock response to this control under widely variable spatial and temporal scales—nanometer to kilometer and microseconds to millennia—is key to these sectors. Since the majority of the subsurface cannot be observed directly, significant advances in sensing technologies, modeling, and simulation are required to advance the state of the art. This needs to be done at low risk in a challenging high-pressure, high-temperature, corrosive environment with effective ongoing monitoring of reservoir integrity.
- **Materials:** Materials properties dictate the performance limits of an energy technology. Changing these properties in the next generation of materials can dramatically improve performance; for example, increasing the strength-to-weight ratio of materials used in vehicles can improve fuel efficiency. Building solar cells with earth-abundant materials having high photon-to-current efficiencies can help make solar energy cost competitive. Materials that are stable at extreme temperatures or large radiation flux can improve the efficiency of fossil and nuclear electric power plants, respectively. New materials for next-generation energy technologies are inherently more complex, containing both more components and novel nanoscale structures. Materials R&D requires leveraging experimental and computational tools. Designing materials to meet specific performance needs requires research that couples theory, modeling, and simulation with *in situ* and *in operando* characterization. Materials designed *in silico* with novel structures will require novel nanoscale synthesis techniques and subsequent characterization under operating conditions to validate computational models. Integrating new materials into energy technologies requires advanced capabilities for manufacturing scale-up, real-time process characterization, process control, and performance validation. The importance of these capabilities is reflected in the multiagency Materials Genome Initiative launched in 2012. Taken together, these capabilities have the potential to dramatically accelerate and reduce the cost of developing new energy technologies.
- **Fuel-engine co-optimization:** Engine performance, which drives efficiency across the entire transportation fleet, can be limited by the properties of the fuels available. With bio-derived, and/or other synthetic fuels, there is an opportunity to optimize the end-to-end fuel-vehicle system for improved efficiency and reduced environmental impacts. Engines that take advantage of the special properties of appropriately engineered fuels may be able to operate at higher compression ratios and under alternate combustion regimes (such as homogeneous or partly stratified charge). Similarly, fuels



derived from non-petroleum feedstocks can be formulated for use in advanced technology engines. A co-optimized fuel and engine system therefore has the potential to improve fleet-scale efficiency and reduce vehicle-out GHG emissions. Fuels derived from low, zero, or negative-carbon feedstocks and processes will result in further emission reductions. Foundational science and technology research that crosscuts the fuels and transport sectors is required to achieve these goals.

- **Energy storage:** Effective and economic energy storage is essential to the transportation sector as well as the evolving electric grid. Storage technologies with higher gravimetric and volumetric energy density that currently available are required for electric vehicles if they are to compete with conventional vehicle range and refueling times. For the grid, lower-cost energy storage will likely be important for high penetrations of renewable resources such as distributed photovoltaic systems, in conjunction with fast-acting technologies required to provide voltage support, frequency regulation and other grid services. RDD&D on efficient, durable, and safe energy storage technologies could enable transformational change across transportation, electric power, and buildings.

The four crosscutting enabling tools listed below represent existing and evolving capabilities in the public and private sectors that, when directed at supporting energy technology and system RDD&D, could drive transformational innovations. Key RDD&D opportunities for consideration include the following:

- **Computational modeling and simulation:** Large increases in computational capability, driven both by advances in chip technology and integration of more processors into massively parallel supercomputers, have enabled simulation of more complex physical phenomena. This has impacted all stages of the RDD&D process. **Research** in areas including materials for extreme environments, biofuel production, and photovoltaics, is accelerated, thanks to larger and more complex molecular-level simulations. Engineers are increasingly relying on advanced simulation in the design and **development** processes for novel internal combustion engines, wind power systems, and fossil power plants, reducing the need for frequent and expensive prototyping. These same simulation capabilities are enabling modeling and simulation of the behavior of new energy projects at the **demonstration** stage. Advanced simulation capabilities are allowing **deployed** energy systems to run more efficiently. For example, modeling and simulation tools developed through collaborations with DOE's national laboratories and industry are used to understand how existing nuclear reactors can be operated more safely and efficiently, while grid simulation is improving decision making without hardware modifications. In all of these areas, increases in computing power; the development of new mathematical algorithms; and increased integration of simulation with large-scale experiments, technology design processes, and large-scale energy systems will increase the importance of advanced simulation in energy technology.
- **Data and analysis:** Opportunities to apply advanced analytics and management of extremely large data sets transect the entire clean energy economy. In particular, the ability to obtain actionable information from an ever-increasing quantity of data ("Big Data") is both an opportunity and a research need. Increasingly inexpensive and effective ways to monitor and control data-dense energy systems are enabling novel and potentially more resource-efficient, transaction-based control. Enhanced abilities to establish complex correlations in massive and disparate data sets and by automatically synthesizing the results of large quantities of research can materially advance the scientific process. The 2011 QTR established a need for strong capabilities in technology assessment, cost analysis, program planning and evaluation, and impact analysis; in QTR 2015, this continues as an important and central function.
- **Analysis of complex systems:** Given the convergence of the energy system and its technical systems, advancements in complex systems analysis need to be coupled with the benefits of the confluence of theory, modeling, synthesis, and characterization and advancements in areas of computational

modeling and simulation, data and analysis, and decision science (including risk analysis) to effectively facilitate the transition to a clean energy economy. The development of a predictive understanding of energy-relevant biological and environmental systems has applications from microbial biofuel production to carbon storage and environmental transport. The detailed understanding of how Earth's dynamic, physical, and biogeochemical systems interact enables prediction of climate change impacts and planning for future energy needs.

- **Characterization and control of matter at multiscales:** Extraordinary advances in observation and characterization of materials and chemistry have paved the way for manipulating materials at the nano- and mesoscale to create new tailored functionalities.
  - **X-ray light sources** provide ultra-high intensity focused X-ray beams that allow scientists to probe the structure of matter at the electronic, atomic, and molecular levels. The knowledge gained will enable scientists to design revolutionary new forms of matter with tailored properties having applications in chemical, material, life, and geosciences. X-ray free electron lasers, such as the Linac Coherent Light Source at SLAC National Accelerator Laboratory are providing entirely new scientific capabilities to probe the ultrafast time evolution of complex chemical reactions.
  - **Neutron sources** such as the Spallation Neutron Source at Oak Ridge National Laboratory are ideal for probing the structure and dynamics of materials containing light atoms, magnetic materials, or macroscale samples that require deep penetration. Emerging neutron source technologies can enable new science from condensed matter to biomaterials and world-leading resolution in 3D structural measurements.

The nanoscale science research centers integrate theory, synthesis, fabrication, and characterization of novel nano- and mesoscale systems to develop the next generation of materials for energy technology. New techniques in fabrication based on high-throughput synthesis and self-assembly and characterization by multifunctional probes with increasing spatial and temporal resolutions have the potential to accelerate the pace of materials discovery and development.

## 11.9 Analysis and Execution

Pursuing RDD&D opportunities that are impactful to the nation's security, economic, and environmental goals require analytical methodologies in portfolio management and innovative frameworks through which to pursue the scientific and technical challenges.

### 11.9.1 RDD&D Portfolio Analysis

Evaluating the potential impact of an RDD&D portfolio requires multiple considerations. For example, the potential performance improvements that change the security, economic, and environmental impacts of a set of technologies must be characterized. Additionally, the potential market deployment (and its reliance on economies of scale, learning, business model assumptions, and additional supporting infrastructure) must be estimated and the resulting effects considered. The analytical tools are described in the following broad categories:

- **Technology planning and projection:** Many organizations perform roadmapping with inputs that include expert elicitation and estimates of technology readiness levels. This QTR discusses activities required for integrating this roadmapping process.
- **Analysis tools and metrics:** There is no single metric that can be used to comprehensively assess and compare RDD&D opportunities. Rather, it is important to have a consistent and common set of tools

and metrics to enable effective comparison. Such tools include security assessments of reliability and resilience, financial analysis such as the delivered cost of energy services, and environmental metrics for GHG emissions and air, water, and land impacts. Life-cycle assessment methodologies can be used to frame these analyses.

- **Evaluation tools:** The risk of whether research will be successful, the uncertainties of a rapidly changing world, and the many interacting energy services needed together motivate the assembly of a portfolio of technologies for RDD&D. This can improve the likelihood of success, but because of the many ways different technologies may compete or complement one another, this also requires evaluating the entire portfolio and not simply individual technologies. Options space analysis, wedge analysis, integrated assessment models, and real-options valuation are some of the approaches to be considered for assessing the research portfolio.

The analytical tools developed in these areas should remain flexible to changes in investment decisions as conditions change.

### 11.9.2 RDD&D Execution

The paradigm of scientific inquiry pursued by a single investigator or small, co-located research team has expanded dramatically over the past decades to include both that original vision as well as a wide variety of multi-institutional, multi-investigator collaboration models. These models can accelerate the RDD&D process in three ways: 1) by enhancing “horizontal” information transfer between groups of researchers who work competitively and collaboratively on a topic, 2) by enhancing “vertical” information transfer between the different stages of the RDD&D pipeline, and 3) by transecting industry, national laboratories, and academia, each of which can bring complementary strengths to a given problem. Selection of the mechanism(s) to pursue any specific opportunity is a complex process. A selection of key existing and emerging mechanisms include the following:

- **Multidisciplinary, multiscale research:** Many federal agencies are moving toward vertically integrated, topically focused research activities. This fosters crossdisciplinary collaboration through an integrated research structure to tackle the most challenging science and engineering problems. The DOE-supported Centers, Hubs, and Institutes described in Chapter 9 are examples of such collaborations across disciplines and across basic science and applied technology development.
- **Technology transition to the economy:** The national laboratories can improve the nation’s economy both by driving strategic industries in pursuit of national science driven missions in security, science, and energy; by generating and promulgating intellectual property; and by facilitating the access of private sector entities to the unique R&D capabilities and staffs of the laboratories. The R&D activities pursued by the national laboratories, and the knowledge gained in the process, thus can have both direct and secondary economic impacts.
- **Public-private consortia:** These activities are convened by government entities but include significant participation by industry. Consortia engage in precompetitive research activities under a formal agreement that covers the work to be performed and how information will be shared. Thus, consortia enable joint research on platform technologies and early stage research in a technical field and leave participants free to build on the shared information to create proprietary outcomes of commercial utility.
- **Alliances and coalitions:** Providing organizational and/or financial support to industrial alliances and coalitions—such as the Better Buildings Alliance and the Clean Cities Coalition—is intended to result in rapid propagation of best practices and broad uptake of technology innovations.

Continued innovation of novel modalities applied to different RDD&D opportunities is required by the nature of the challenges that these technologies address.

### 11.10 Concluding Thoughts

The systems perspective used in the development of this second Quadrennial Technology Review has enabled the identification of energy systems convergence, diversity within sectors, and efficiency everywhere as broad themes for organizing RDD&D activities. Additionally, the integration of fundamental research opportunities with technology development programs has enabled the identification of the confluence of advanced research tools, such as high-performance computing and materials characterization facilities, with design and control of complex systems, as a new paradigm in RDD&D.

Energy stakeholders can take advantage of the rapidly emerging set of tools for creating new generations of materials, devices, and systems for energy applications. Strengthened analysis and assessment programs should inform sector-specific and crosscutting RDD&D initiatives. Continuing to drive a well-diversified portfolio of energy research is essential to meeting the strategic objectives of the nation.





# Appendices

List of Technology Assessments

List of Supplemental Information

Office of the Under Secretary for Science and  
Energy Executive Steering Committee and Co-Champions

Authors, Contributors, and Reviewers

Glossary

Acronyms

List of Figures

List of Tables





# Technology Assessments

## Chapter 3

Cyber and Physical Security  
Designs, Architectures, and Concepts  
Electric Energy Storage  
Flexible and Distributed Energy Resources  
Measurements, Communications, and Control  
Transmission and Distribution Components

## Chapter 4

Advanced Plant Technologies  
Carbon Dioxide Capture and Storage  
Value-Added Options  
Biopower  
Carbon Dioxide Capture Technologies  
Carbon Dioxide Storage Technologies  
Carbon Dioxide Capture for Natural Gas  
and Industrial Applications  
Crosscutting Technologies in Carbon Dioxide  
Capture and Storage  
Fast-spectrum Reactors  
Geothermal Power  
High Temperature Reactors  
Hybrid Nuclear-Renewable Energy Systems  
Hydropower  
Light Water Reactors  
Marine and Hydrokinetic Power  
Nuclear Fuel Cycles  
Solar Power  
Stationary Fuel Cells  
Supercritical Carbon Dioxide Brayton Cycle  
Wind Power

## Chapter 6

Additive Manufacturing  
Advanced Materials Manufacturing  
Advanced Sensors, Controls, Platforms  
and Modeling for Manufacturing  
Combined Heat and Power Systems  
Composite Materials  
Critical Materials  
Direct Thermal Energy Conversion  
Materials, Devices, and Systems  
Materials for Harsh Service Conditions  
Process Heating  
Process Intensification  
Roll-to-Roll Processing  
Sustainable Manufacturing - Flow of  
Materials through Industry  
Waste Heat Recovery Systems  
Wide Bandgap Semiconductors for  
Power Electronics

## Chapter 7

Bioenergy Conversion  
Natural Gas Delivery Infrastructure  
Biomass Feedstocks and Logistics  
Gas Hydrates Research and Development  
Hydrogen Production and Delivery  
Offshore Safety and Spill Reduction  
Unconventional Oil and Gas

## Chapter 8

Connected and Automated Vehicles  
Fuel Cell Electric Vehicles  
Internal Combustion Engines  
Lightweight Automotive Materials  
Plug-in Electric Vehicles

[See online version.]



# Supplemental Information

## Chapter 1

Additional Information on Energy Challenges  
Agency Information  
Representative DOE Applied Energy Program Workshops

## Chapter 5

Building Energy Technology Roadmaps  
Building Technologies Office Potential Energy Savings Analysis

## Chapter 6

Competitiveness Case Studies  
Public-Private Consortia and Technology Transition Case Studies

## Chapter 7

Oil and Gas Technologies  
Subsurface Science and Technology

## Chapter 9

A Comparison of Research Center Funding Modalities  
High-Performance Computing Capabilities and Allocations  
User Facility Statistics  
Examples and Case Studies

## Chapter 10

Additional Information on Concepts in Integrated Analysis

[See online version.]



# Office of the Under Secretary for Science and Energy Executive Steering Committee and QTR Co-Champions

Any endeavor the size and scope of the QTR 2015 requires strong leadership and dedication of resources. The individuals listed below represent the senior leaders within DOE who provided the essential guidance and key resources which made this report possible.

## **Office of the Under Secretary for Science and Energy**

Kimberly D. Rasar, *Associate Deputy Under Secretary*

## **Office of Electricity Delivery and Reliability**

Henry (Hank) Kenchington, *Deputy Assistant Secretary, for Advanced Grid Integration*

David Ortiz, *Deputy Assistant Secretary for Energy Infrastructure Modeling and Analysis*

## **Office of Energy Efficiency and Renewable Energy**

Steve Chalk, *Deputy Assistant Secretary for Operations*

Doug Hollett, *Deputy Assistant Secretary for Renewable Power*

Mark A. Johnson, *Director, Advanced Manufacturing Office*

Roland Risser, *Director, Building Technologies Office*

Reuben Sarkar, *Deputy Assistant Secretary for Transportation*

## **Office of Fossil Energy**

Julio Friedmann, *Principal Deputy Assistant Secretary*

David Mohler, *Deputy Assistant Secretary, Office of Clean Coal and Carbon Management*

Darren Mollot, *Associate Deputy Assistant Secretary, Office of Clean Coal and Carbon Management*

## **Office of Nuclear Energy**

John E. Kelly, *Deputy Assistant Secretary for Nuclear Reactor Technologies*

## **Office of Indian Energy**

Pilar Thomas, *Former Acting Director, Office of Indian Energy Policy & Programs*

David Conrad, *Deputy Director, Office of Indian Energy Policy and Programs*

## **Office of Technology Transitions**

Jetta Wong, *Director and Department Technology Transfer Coordinator*

## **Office of Science**

Pat Dehmer, *Acting Director of Science*

Steve Binkley, *Associate Director of Advanced Scientific Computing Research*

Harriet Kung, *Associate Director of Science for Basic Energy Sciences*

## **Advanced Research Projects Agency - Energy**

Ellen Williams, *Director, Advanced Research Projects Agency - Energy*

## **Office of the Chief Financial Officer**

Christopher (Chris) Johns, *Director of the Budget Office*

## **Office of International Affairs**

Robert (Bob) Marlay, *Director, Office of International Science and Technology Collaboration*



## Authors

The QTR 2015 was executed by a core team responsible for all aspects of production including drafting the report, engaging stakeholders, managing the peer review process, and leading the technology assessments. In addition, they provided connectivity within the department ensuring a cogent and integrated view of the nation's broad energy RDD&D enterprise.

Sam Baldwin  
*DOE*

Gilbert Bindewald  
*DOE*

Austin Brown  
*National Renewable  
Energy Laboratory*

Charles Chen  
*Energetics*

Kerry Cheung  
*DOE*

Corrie Clark  
*Argonne National Laboratory*

Joe Cresko  
*DOE*

Matt Crozat  
*DOE*

Jarad Daniels  
*DOE*

Jae Edmonds  
*Pacific Northwest  
National Laboratory*

Paul Friley  
*Brookhaven National  
Laboratory*

Jeff Greenblatt  
*Lawrence Berkeley  
National Laboratory*

Zia Haq  
*DOE*

Kristen Honey  
*DOE (AAAS Fellow)*

Marcos Huerta  
*DOE*

Ziga Ivanic  
*Energetics*

William Joost  
*DOE*

Fred Joseck  
*DOE*

Akhlesh Kaushiva  
*DOE*

Henry Kelly  
*DOE*

Dan King  
*DOE (AAAS Fellow)*

Adam Kinney  
*DOE (AAAS Fellow)*

Michael Kuperberg  
*DOE*

Alan Kwan  
*DOE (AAAS Fellow)*

Alex Larzelere  
*DOE*

Heather Liddell  
*Energetics*

Steve Lindenberg  
*DOE*

Michael Martin  
*DOE (AAAS Fellow)*

Colin McMillan  
*National Renewable  
Energy Laboratory*

Elena Melchert  
*DOE*

Josh Mengers  
*DOE*

Eric Miller  
*DOE*

James Miller  
*Argonne National Laboratory*

George Muntean  
*Pacific Northwest  
National Laboratory*

Tien Nguyen  
*DOE*

Pat Phelan  
*DOE*

Charles Russomanno  
*DOE*

Ridah Sabouni  
*Energetics*

Ann Satsangi  
*DOE*

Andrew Schwartz  
*DOE*

Dev Shenoy  
*DOE*

A.J. Simon  
*Lawrence Livermore  
National Laboratory*

Gurpreet Singh  
*DOE*

Emmanuel Taylor  
*DOE*

Jake Ward  
*DOE*

Bradley Williams  
*DOE*

## Contributors

In addition to the core team of lead authors, the report and technology assessments would not have been completed without numerous valuable contributions. Essential material was provided and/or produced by the individuals listed below. The QTR 2015 is indebted to them for their critical contributions.

Omar Abdelaziz  
*DOE*

Mark Ackievicz  
*DOE*

Anant Agarwal  
*DOE*

David Anderson  
*DOE*

Todd Anderson  
*DOE*

Kristin Balder-Froid  
*Lawrence Berkeley  
National Laboratory*

Fredric Beck  
*SRA International*

Doug Blankenship  
*Sandia National Laboratories*

Richard Boardman  
*Idaho National Laboratory*

Dan Boff  
*Mantech Corporation*

Ray Boswell  
*National Energy  
Technology Laboratory*

Anthony Bouza  
*DOE*

Shannon Bragg-Sitton  
*Idaho National Laboratory*

Jay Braitsch  
*DOE*

Megan Brewster  
*DOE*

Lynn Brickett  
*National Energy  
Technology Laboratory*

James Brodrick  
*DOE*

Benjamin Brown  
*DOE*

Douglas Burns  
*Idaho National Laboratory*

Lou Capitanio  
*DOE*

Alberta Carpenter  
*National Renewable  
Energy Laboratory*

Julie Carruthers  
*DOE*

David Catarious  
*DOE*

Jeff Chamberlain  
*Argonne National Laboratory*

Isaac Chan  
*DOE*

Jared Ciferno  
*National Energy  
Technology Laboratory*

Regis Conrad  
*DOE*

George Crabtree  
*Argonne National Laboratory*

Fred Crowson  
*Energetics*

Sujit Das  
*Oak Ridge National  
Laboratory*

Patrick Davis  
*DOE*

Ravi Deo  
*DOE*

Rick Diamond  
*Lawrence Berkeley  
National Laboratory*

Sara Dillich  
*DOE*

Kevin Doran  
*DOE*

Amgad Elgowainy  
*Argonne National Laboratory*

Rick Elliott  
*DOE*

Phillip Finck  
*Idaho National Laboratory*

Aaron Fisher  
*Energetics*

Jay Fitzgerald  
*DOE (AAAS Fellow)*

Erica Folio  
*DOE*

David Forrest  
*DOE*

Christopher Freitas  
*DOE*

Benjamin Gaddy  
*DOE (AAAS Fellow)*

John Gangloff  
*DOE*

Nancy Garland  
*DOE*

Chris Gearhart  
*National Renewable  
Energy Laboratory*

Gary Geernaert  
*DOE*



Jess C. Gehin  
*Oak Ridge National Laboratory*

Bob Gemmer  
*DOE*

Kristin Gerdes  
*National Energy  
Technology Laboratory*

Jehanne Gillo  
*DOE*

Patrick Glynn  
*DOE*

Mike Goff  
*DOE*

Jeffery Gonder  
*National Renewable  
Energy Laboratory*

Roland Gravel  
*DOE*

Diane Graziano  
*Argonne National Laboratory*

Joel Grimm  
*DOE*

Timothy Hallman  
*DOE*

Dave Hardy  
*DOE*

Chioke Harris  
*DOE*

Eric Heim  
*E Heim Consulting*

George Hernandez  
*Pacific Northwest  
National Laboratory*

Robert Hill  
*Argonne National Laboratory*

Devin Hodge  
*Argonne National Laboratory*

Linda Horton  
*DOE*

Ken Howden  
*DOE*

David Howell  
*DOE*

Sara Hunt  
*BCS, Inc*

Bob Hwang  
*Sandia National Laboratories*

Keith Jamison  
*Energetics*

Thomas Jenkins  
*National Renewable  
Energy Laboratory*

Robin Johnston  
*Lawrence Berkeley  
National Laboratory*

Robert Kaplar  
*Sandia National Laboratories*

Burton 'Mack' Kennedy  
*Lawrence Berkeley  
National Laboratory*

Chris King  
*DOE*

Alex King  
*Ames Laboratory*

Douglas Kothe  
*Oak Ridge National Laboratory*

Alison LaBonte  
*DOE*

Sandy Landsberg  
*DOE*

Karl Lang  
*National Energy  
Technology Laboratory*

Jared Langevin  
*DOE*

Peter Lee  
*DOE*

Robie Lewis  
*DOE*

John Litynski  
*DOE*

Henning Lohse-Busch  
*Argonne National Laboratory*

Roy Long  
*National Energy  
Technology Laboratory*

Seungwook Ma  
*DOE*

Jonathan Male  
*DOE*

Maggie Mann  
*National Renewable  
Energy Laboratory*

George Maracas  
*DOE*

Robert Margolis  
*National Renewable  
Energy Laboratory*

Laura Marlino  
*Oak Ridge National Laboratory*

Blake Marshal  
*DOE*

Eric Masanet  
*Northwestern University*

Jack Mayernik  
*DOE*

Kathryn McCarthy  
*Idaho National Laboratory*

Mike McKittrick  
*DOE*

Gail McLean  
*DOE*

Alan Meier  
*Lawrence Berkeley  
National Laboratory*

Marc Melaina  
*National Renewable  
Energy Laboratory*

David C. Miller  
*National Energy  
Technology Laboratory*

Subhashree Mishra  
*DOE (AAAS Fellow)*

Mark Morgan  
*Pacific Northwest  
National Laboratory*

Geoff Morrison  
*DOE*

William R. Morrow, III  
*Lawrence Berkeley  
National Laboratory*

James Murphy  
*DOE*

Gene Nardella  
*DOE*

Jay Nathwani  
*DOE*

Brent Nelson  
*DOE*



Sachin Nimbalkar  
*Oak Ridge National  
Laboratory*

Olayinka Ogunsola  
*DOE*

Ed Owens  
*DOE*

Burak Ozpineci  
*Oak Ridge National  
Laboratory*

Dimitrios Papageorgopoulos  
*DOE*

Mike Penev  
*National Renewable  
Energy Laboratory*

Mark Peters  
*Argonne National Laboratory*

David Petti  
*Idaho National Laboratory*

Tanja Pietrass  
*DOE*

Anand Raghunathan  
*Energetics*

James Rhyne  
*DOE*

Matthew Riddle  
*University of Massachusetts*

Brian Robinson  
*DOE*

Gary Rochau  
*Sandia National Laboratories*

Traci Rodosta  
*National Energy  
Technology Laboratory*

Susan Rogers  
*DOE*

Robert Romanosky  
*National Energy  
Technology Laboratory*

Amir Roth  
*DOE*

Tom Russell  
*DOE*

William Sanders  
*University of Illinois*

Sunita Satyapal  
*DOE*

Erin Searcy  
*DOE*

Arman Shehabi  
*Lawrence Berkeley  
National Laboratory*

John H. Shinn  
*Carbon Capture  
Simulation Initiative*

Anna Shipley  
*SRA International*

James Siegrist  
*DOE*

Jerry Simmons  
*Sandia National Laboratories*

Wade Sisk  
*DOE*

Eric Smistad  
*National Energy  
Technology Laboratory*

Sarah Smith  
*Lawrence Berkeley  
National Laboratory*

Jacob Spendelov  
*Los Alamos National  
Laboratory*

Thomas Stephens  
*Argonne National Laboratory*

Ned Stetson  
*DOE*

John Storey  
*Oak Ridge National Laboratory*

Kevin Stork  
*DOE*

Sarah Studer  
*DOE*

Deborah Sunter  
*DOE*

Erika Sutherland  
*DOE*

Ed Synakowski  
*DOE*

Timothy Theiss  
*Oak Ridge National Laboratory*

Arvind Thekdi  
*Energy and Environmental  
Efficiency Management, Inc*

Claudia Tighe  
*DOE*

Tony Tubiolo  
*DOE*

Paul Turinsky  
*North Carolina  
State University*

Rich Tusing  
*DOE*

Bradley Ullrick  
*Argonne National Laboratory*

Michael Ulsh  
*National Renewable  
Energy Laboratory*

Alfonso Valdes  
*Trustworthy Cyber  
Infrastructure for  
the Power Grid*

James Van Dam  
*DOE*

John Vetrano  
*DOE*

Laura Vimmerstedt  
*National Renewable  
Energy Laboratory*

Kelly Visconti  
*DOE*

Anant Vyas  
*Argonne National Laboratory*

Brian Walker  
*DOE (AAAS Fellow)*

Hsin Wang  
*Oak Ridge National  
Laboratory*

Sharlene Weatherwax  
*DOE*

Devin West  
*Oak Ridge National  
Laboratory*

John Wimer  
*National Energy  
Technology Laboratory*

Joyce Yang  
*DOE*

Yan (Joann) Zhou  
*Argonne National Laboratory*



## Reviewers

Extensive stakeholder inputs and peer reviews were considered in the drafting of this report. The external reviewers selected were all recognized experts in science and energy technology RDD&D. Their advice was considered on that basis, not as representatives of any particular organization or institution. Their comments were incorporated as appropriate, which greatly improved the accuracy and quality of the report. Any remaining inconsistencies or errors are not to be attributed to the reviewers. The individuals that participated in the review process are listed below. Their organizational affiliation is listed only to assist in identification and does not imply any form of endorsement.

Kev Adjemian  
*Idaho National Laboratory*

David Allen  
*University of Texas*

Tim Allison  
*Southwest Research Institute*

Laura Diaz Anadon  
*Harvard University*

Iver Anderson  
*Ames National Lab*

Brian Anderson  
*West Virginia University*

Stacy Angel  
*EPA*

Don Anton  
*Savannah River  
National Laboratory*

Chris Apblett  
*Sandia National Laboratories*

Doug Arent  
*National Renewable  
Energy Laboratory*

Renata Arsenault  
*Ford Motor Company*

Ed Arthur  
*University of New Mexico*

Terry Aselage  
*Sandia National Laboratories*

Misra Ashutosh  
*ITN Energy Systems*

Stan Atcitty  
*Sandia National Laboratories*

Robert D. Atkinson  
*The Information  
Technology & Innovation  
Foundation*

Chad Augustine  
*National Renewable  
Energy Laboratory*

Richard Axelbaum  
*Washington University,  
St. Louis*

Kathy Ayers  
*Proton Energy Systems*

Justin Baca  
*Solar Energy Industry  
Association*

Joe Badin  
*USDA*

Grechen Baier  
*The Dow Chemical Company*

Erin Baker  
*University of Massachusetts*

William Ball  
*Southern Company*

Xuegang (Jeff) Ban  
*Rensselaer Polytechnic  
Institute*

Suji Banerjee  
*Monolith Semiconductor*

Ezra Bar Ziv  
*Michigan Tech University*

Galen Barbose  
*Lawrence Berkeley  
National Laboratory*

Yaneer Bar-Yam  
*New England Complex  
Systems Institute*

Mary Rose Bayer  
*EPA*

Kristin Bennett  
*kbScience*

Crystal Bergeman  
*HUD*

Alan Berscheid  
*Los Alamos National  
Laboratory*

Dipka Bhambhani  
*Breitling Energy*

Abhoyjit Bhowm  
*Electric Power Research  
Institute*

Jim Biershenk  
*Marlow Industries*

Gil Bindewald  
*DOE*

Doug Blankenship  
*Sandia National Laboratory*

Richard Boardman  
*Idaho National Laboratory*

William B. Bonvillian  
*Massachusetts Institute  
of Technology*

Rod Borup  
*Los Alamos National  
Laboratory*

Anjan Bose  
*Washington State University*

Terry Boss  
*Interstate Natural Gas Association of America*

Steve Bossart  
*National Energy Technology Laboratory*

Paul Boyd  
*Pacific Northwest National Laboratory*

Howard Branz  
*DOE*

Gerry Braun  
*University of California, Davis*

Jeanne Briskin  
*EPA*

Arturo Bronson  
*University of Texas at El Paso*

Marilyn Brown  
*Georgia Institute of Technology*

Esther Bryan  
*DOE*

Paul Bryan  
*University of California Berkeley*

Jonathon Burbaum  
*DOE*

Vann Bush  
*Gas Technology Institute*

Thomas Butcher  
*Brookhaven National Laboratory*

Sandy Butterfield  
*NWTC*

John Cabaniss  
*DOE*

Elizabeth Cantwell  
*Arizona State University*

Stewart Cedres  
*DOE*

Cheryl L. Cejka  
*Sandia National Laboratories*

Paul Centolella  
*Paul Centolella & Associates*

Luis Cerezo  
*EPRI*

Ruey Chen  
*NSF*

Charlie Chen  
*Energetics*

Gang Chen  
*Massachusetts Institute of Technology*

Chen Chen  
*Argonne National Laboratory*

Andrea Cherepy  
*EPA*

Diane Chinn  
*Lawrence Livermore National Laboratory*

Lalit Chordia  
*Thar Energy LLC*

Srabanti Chowdhury  
*Arizona State University*

Peter Christensen  
*Pacific Northwest National Laboratory*

Craig Christenson  
*Turbine Technology Partners*

David Claridge  
*Texas A&M*

Charlton Clark  
*DOE*

Steven Clark  
*Chrysler Corporation*

John Clarke  
*Industrial Heating Equipment Association*

Kipp Coddington  
*University of Wyoming*

James Cole  
*Idaho National Laboratory*

Tim Collett  
*USGS*

Regis Conrad  
*DOE*

Guenter Conzelmann  
*Argonne National Laboratory*

Ben Cook  
*NASA*

Khershed Cooper  
*National Science Foundation*

Doug Crawford  
*Genomics Institute*

Michael Crawford  
*DuPont*

Mary Ann Curran  
*BAMAC, Ltd.*

Aiguo Dai  
*State University of New York - Albany*

Abigail Daken  
*EPA*

Jeff Daniels  
*The Ohio State University*

Edward Daniels  
*Argonne National Laboratory*

Sujit Das  
*Oak Ridge National Laboratory*

John Davinson  
*IEA*

Jim Davis  
*University of California, Los Angeles*

Steven Davis  
*University of California, Irvine*

Joe Decarolis  
*North Carolina State University*

Mark DeFigueiredo  
*EPA*

Phil DiPietro  
*GE*

Ian Dobson  
*Iowa State University*

Steve Duclos  
*GE*

Catherine Dunwoody  
*California Air Resources Board*

Steve Durbin  
*Purdue University*

Betsy Dutrow  
*EPA*

Jim Easterly  
*Black & Veatch*



Laurence Eaton  
*Oak Ridge National  
Laboratory*

Matthew Eckelman  
*Northeastern University*

Elizabeth Eide  
*National Academy of Sciences*

Jack Eisenhower  
*Nexight Group*

Bruce Eldridge  
*University of Texas*

Mark Elless  
*DOE*

Ross Elliott  
*EPA*

Derek Elsworth  
*Penn State*

Marleen Esprit  
*Umicore*

Joe Eto  
*Lawrence Berkeley  
National Laboratory*

Paul Evans  
*University of Wisconsin*

Ron Faibish  
*DOE*

Srinivas Farimella  
*Georgia Institute of  
Technology*

John Farrell  
*National Renewable  
Energy Laboratory*

Cynthia Feller  
*Ames National Lab*

Thomas Felter  
*Sandia National Laboratories*

Mike Fero  
*TeslaGen*

Rob Finley  
*University of Illinois*

Bill Flanagan  
*GE*

Jean-Pierre Fleuriel  
*NASA Jet Propulsion  
Laboratory*

Mike Focazio  
*USGS*

Charles Forsberg  
*Massachusetts Institute  
of Technology*

Rita Foster  
*Idaho National Laboratory*

Michel Fouré  
*Lawrence Berkeley  
National Laboratory*

Joe Fowler  
*Stress Engineering*

Amy Francetic  
*Clean Energy Trust*

Pamela Franklin  
*EPA*

Joe Frantz  
*Range Resources*

Kristina Friedman  
*EPA*

Daniel Friend  
*NIST*

Steve Fruh  
*EPA*

Matt Frye  
*BOEM*

Erica R.H. Fuchs  
*Carnegie Mellon University*

Peter Fuhr  
*Oak Ridge National  
Laboratory*

Brent Fultz  
*California Institute of  
Technology*

Anne Gaffney  
*Idaho National Laboratory*

John Gale  
*International Energy Agency*

Josh Gange  
*NOAA*

Srinivas Garimella  
*Georgia Institute of  
Technology*

Jay Garland  
*EPA*

Clark Gellings  
*EPRI*

Sarah Genovese  
*GE*

Hossein Ghezeli-Ayagh  
*FuelCell Energy*

Dolf Gielen  
*IRENA*

Ken Gillingham  
*Yale University*

Jill Glass  
*Sandia National Laboratories*

Leo Goff  
*ACARYIS, CNA Corporation*

Mike Goff  
*Idaho National Laboratory*

Jarett Goldsmith  
*DNV GL*

Barb Goodman  
*National Renewable  
Energy Laboratory*

Tip Goodwin  
*Oncor Electric Delivery*

Anand Gopal  
*Lawrence Berkeley  
National Laboratory*

Bhaskaran Gopalakrishnan  
*West Virginia University*

Avi Gopstein  
*U.S. Department of State*

Charles Gorecki  
*UNDEERC*

Alison Gotkin  
*UTRC*

David Gotthold  
*Pacific Northwest  
National Laboratory*

Tom Graedel  
*Yale University*

Sallie Greenberg  
*University of Illinois*

David Greene  
*University of Tennessee*

Chris Greer  
*NIST*

David Greves  
*Carnegie Mellon University*

Teresa Grocela-Rocha  
*GE*

Ignacio Grossman  
*Carnegie Mellon University*

Neeraj Gupta  
*Battelle*

Angela Hackel  
*EPA*

Nancy Haegel  
*National Renewable Energy  
Laboratory*

Christian Hageleuken  
*Umicore*

Michael Hagood  
*Idaho National Laboratory*

Ian Hamos  
*DOE*

Rachna Handa  
*DOE*

Bryan Hannegan  
*National Renewable  
Energy Laboratory*

John Harju  
*UNDEERC*

Mike Harpster  
*General Motors*

Debbie Haught  
*DOE*

Rich Haut  
*Houston Advanced  
Research Center*

Troy Hawkins  
*Enviance*

Carla Heathman  
*Idaho National Laboratory*

Christopher Hedge  
*NOAA*

Grant Heffelfinger  
*Sandia National Laboratories*

Allen Hefner  
*NIST*

Michael Heitkamp  
*Savannah River National  
Laboratory*

James Hemby  
*EPA*

Craig Henderson  
*DOE*

James Hendler  
*Rensselaer Polytechnic  
Institute*

Jeff Hendrix  
*MRCComposites*

Tom Hennebel  
*University of California,  
Berkeley*

Jordan Henry  
*Sandia National Laboratories*

Steve Herring  
*Idaho National Laboratory*

Howard Herzog  
*Massachusetts Institute  
of Technology*

John Hofmeister  
*Lufkin*

Patrick Holman  
*DOE*

Susan Holmes  
*NOAA*

Roland Horne  
*Stanford University*

David Horton  
*FERC*

Linda Horton  
*DOE*

Nancy Horton  
*Energy Industries of Ohio, Inc.*

Marc Houyoux  
*EPA*

Sue Hovorka  
*UT-BEG*

David Howard  
*DOE*

John Hryn  
*Argonne National Laboratory*

Solomon Hsiang  
*University of California,  
Berkeley*

Henry Huang  
*Pacific Northwest  
National Laboratory*

David Hungerford  
*California Energy Commission*

Daniel Hussey  
*NIST*

Dennis Hussey  
*EPRI*

Nick Hutson  
*EPA*

Mike Hyland  
*American Public  
Power Association*

Britt Ide  
*Ide Law Strategy*

George Imel  
*Idaho State University*

Bill Irving  
*EPA*

Chris Irwin  
*DOE*

Kyle Isakower  
*American Petroleum Institute*

Cindy Jacobs  
*EPA*

Don Jacobsen  
*Noble Corporation*

David Jacobson  
*NIST*

Kristina Johnson  
*Enduring Hydro*

Tom Johnson  
*Southern Company*

Eddie Johnston  
*Gas Technology Institute*

Mark Jonkhof  
*GE*

Ajey Joshi  
*Applied Materials*

David Julius  
*Duke Energy*

Andy Kadak  
*Exponent*

Landis Kannberg  
*Pacific Northwest  
National Laboratory*

Anhar Karimjee  
*EPA*



Akhlesh Kaushiva  
*DOE*

Curtis Keliiaa  
*Sandia National Laboratories*

Klaus Keller  
*Penn State University*

Jay Keller  
*Sandia National  
Laboratories (retired)*

Sean Kelly  
*Praxair*

Mack Kennedy  
*Lawrence Berkeley  
National Laboratory*

John Kessler  
*EPRI*

Jim Ketcham-Colwill  
*EPA*

Haroon Khashji  
*Exxon Mobile*

Himanshu Khurana  
*Honeywell*

Ed Kiczek  
*Airproducts*

Hyung Chul Kim  
*Ford Motor Company*

Joyce Kim  
*DOE*

Thomas King, Jr.  
*Oak Ridge  
National Laboratory*

Michael Kintner-Meyer  
*Lawrence Berkeley  
National Laboratory*

Randolph Kirchain  
*Massachusetts Institute  
of Technology*

Harold Kirkham  
*Pacific Northwest  
National Laboratory*

Lindsay Kishter  
*Nexight Group*

James Klausner  
*DOE*

Andrew Klein  
*Oregon State University*

Robert Kleinberg  
*Schlumberger*

Lingard Knutson  
*EPA*

Bruce Kobelski  
*EPA*

Mike Koerber  
*EPA*

Tim Konnert  
*FERC*

John Kopasz  
*Argonne National Laboratory*

George Koperna  
*Advanced Resources  
International*

David Koppenaal  
*Pacific Northwest  
National Laboratory*

Vladimir Koritarov  
*Argonne National Laboratory*

Bruce Kramer  
*NSF*

Ben Kroposki  
*National Renewable  
Energy Laboratory*

Anthony Ku  
*GE*

Abhai Kumar  
*ANSER*

Hannes Kunz  
*ABY*

Thomas Kurfess  
*Georgia Institute of  
Technology*

Ellen Kurlansky  
*EPA*

Greg Kusinski  
*Chevron*

Roxann Laird  
*Southern Company*

Eric Larson  
*Princeton University*

Alan Lauder  
*CCAS*

Jeff Leahey  
*National Hydropower  
Association*

Fred Leavitt  
*Hi-Z*

Audrey Lee  
*Advanced Microgrid Systems*

Chun-Wai Lee  
*EPA*

Richard LeSar  
*Iowa State University*

Reenst Lesemann  
*Columbia Power*

David Lesmes  
*DOE*

Robie Lewis  
*DOE*

T-G Lian  
*EPRI*

Yanna Liang  
*Southern Illinois University*

JoAnn Lighty  
*NSF*

Bill Linak  
*EPA*

Kunlei Liu  
*University of Kentucky*

Yilu Liu  
*Oak Ridge National  
Laboratory*

Ping Liu  
*DOE*

Eric Loewen  
*GE*

Despina Louca  
*University of Virginia*

Xianoan Lu  
*Argonne National Laboratory*

Kevin Lynn  
*DOE*

Jim Lyons  
*Capricorn Investment Group*

Don MacKenzie  
*University of Washington*

Bill Macleod  
*Hyundai-DC*

Peter Madsen  
*Technical University  
of Denmark*

Jorge Magalhaes <i>Vestas</i>	Jim McMahon <i>Cal Energy and Climate</i>	Ed Morris <i>America Makes - NAMII</i>
Ernie Majer <i>Lawrence Berkeley National Laboratory</i>	Steve McMaster <i>DOE</i>	Jacob Moss <i>EPA</i>
Dawn Manley <i>Sandia National Laboratories</i>	Brian McPherson <i>Southwest Partnership</i>	Ralph Mueleisen <i>Argonne National Laboratory</i>
Margaret Mann <i>National Renewable Energy Laboratory</i>	Shreyes Melkote <i>Georgia Institute of Technology</i>	Michael Muller <i>Rutgers</i>
Mike Manwaring <i>MWH</i>	Rob Mellors <i>Lawrence Livermore National Laboratory</i>	David Murphy <i>St Lawrence University</i>
Jason Marcinkoski <i>Fuel Cell Technologies Office</i>	Steve Melzer <i>Consultant</i>	Lawrence Murphy <i>P4EP</i>
Jan Mares <i>Resources for the Future</i>	Robert Meyers <i>EPA</i>	Vinod Narayanan <i>University of California, Davis</i>
John L. Marion <i>Alstom Power, Inc.</i>	Vijay Mhetar <i>General Cable Corporation</i>	Jim Nash <i>Brayton Energy</i>
John Marra <i>Savannah River National Laboratory</i>	Andrew Michener <i>International Energy Agency</i>	Greg Nemet <i>University of Wisconsin</i>
Mitolo Massimo <i>Eaton Corporation</i>	Doug Middleton <i>DOE</i>	Stuart Nemser <i>Compact Membrane Systems</i>
Regis Matzie <i>Westinghouse</i>	Craig Miller <i>National Rural Electric Cooperative Association</i>	Robin Newmark <i>National Renewable Energy Laboratory</i>
James Maughan <i>GE</i>	Jim Miller <i>Argonne National Laboratory</i>	Norris Nicholson <i>USDA</i>
Michael Max <i>Hydrate Energy International</i>	Ted Miller <i>Ford Motor Company</i>	Christopher Noble <i>Massachusetts Institute of Technology</i>
Michael McAdams <i>Advanced Biofuels Association</i>	Liang Min <i>Lawrence Livermore National Laboratory</i>	Bruce Nordman <i>Lawrence Berkeley National Laboratory</i>
David McCarthy <i>Air Products</i>	Florence Mingardon <i>Total</i>	John Northington <i>Southern Company</i>
Tom McCarthy <i>Ford Motor Company</i>	Rob Mitchell <i>USDA</i>	Frank Novacheck <i>Xcel Energy</i>
Dan McConnell <i>Fugro</i>	Darren Mollot <i>DOE</i>	Paul Ohodnicki <i>National Energy Technology Laboratory</i>
Colin McCormick <i>General Motors</i>	Dave Mooney <i>National Renewable Energy Laboratory</i>	Sara Ohrel <i>EPA</i>
Tim McDonald <i>USDA</i>	Mark Morgan <i>Pacific Northwest National Laboratory</i>	Mark O'Malley <i>UC Dublin</i>
Mike McElfresh <i>Argonne National Laboratory</i>	George Moridis <i>Lawrence Berkeley National Laboratory</i>	Dale Osborn <i>Midcontinent Independent System Operator</i>
A. McKane <i>Lawrence Berkeley National Laboratory</i>		Ralph Overend <i>National Renewable Energy Laboratory (Retired)</i>



Mike Pacheco  
*National Renewable  
Energy Laboratory*

Asanga Padmaperuma  
*Pacific Northwest  
National Laboratory*

Joe Paladino  
*DOE*

Chris Paredis  
*National Science Foundation*

Danny Parker  
*University of Central Florida*

Seth Parker  
*Leviton*

George Parks  
*Fuel Science*

ZhiJan Pei  
*NSF*

Leslie Perkins  
*USAF*

Donna Perla  
*EPA*

Kent Peters  
*DOE*

Tanja Pietrass  
*DOE*

Rob Podgorney  
*Idaho National Laboratory*

Brian Polagye  
*University of Washington*

Dana Powers  
*Sandia National Laboratories*

Rick Pratt  
*Pacific Northwest  
National Laboratory*

Rob Pratt  
*Pacific Northwest  
National Laboratory*

Frank Princiotta  
*EPA*

Betty Pun  
*Chevron*

Junjian Qi  
*Argonne National Laboratory*

Feng Qiu  
*Argonne National Laboratory*

Verena Radulovic  
*EPA*

Varun Rai  
*University of Texas, Austin*

Noorie Rajvanshi  
*Siemens*

Anand Rao  
*Independent Consultant*

Robert Rapier  
*Tenaciousdna*

Phil Rasch  
*Pacific Northwest  
National Laboratory*

Dan Rastler  
*EPRI*

Jeff Reed  
*Sempra Energy Utilities*

Joy Rempe  
*Idaho National Laboratory*

Joel Renner  
*National Renewable  
Energy Laboratory*

Mark Rice  
*Pacific Northwest  
National Laboratory*

Craig Rieger  
*Idaho National Laboratory*

Bob Rose  
*EPA*

Mike Rottmayer  
*U.S. Air Force*

Edward Rubin  
*Carnegie Mellon University*

Pablo Ruiz  
*The Brattle Group*

Dave Russ  
*USGS*

Harvey Sachs  
*American Council for an  
Energy Efficient Economy*

William Sanders  
*University of Illinois -  
Urbana-Champaign*

Linda Sapochak  
*National Science Foundation*

Hamid Sarv  
*Babcock & Wilcox*

Roger Sathre  
*Lawrence Berkeley  
National Laboratory*

Genevieve Saur  
*National Renewable  
Energy Laboratory*

Buzz Savage  
*Independent Consultant*

Maxine Savitz  
*Honeywell (ret.)*

Samveg Saxena  
*Lawrence Berkeley  
National Laboratory*

George Schatz  
*Northwestern University*

Joe Schatz  
*Southern Company*

Rich Scheer  
*Scheer Ventures LLC*

David Schmalzer  
*Argonne National Laboratory*

Kevin Schneider  
*Pacific Northwest  
National Laboratory*

Ron Schoff  
*Clean Global Energy*

Laura Schoppe  
*Fuentek*

Art Schroder  
*Energy Valley*

Dan Schultheisz  
*EPA*

Arah Schuur  
*HUD*

James Scofield  
*Air Force Research Lab*

Charles Scouten  
*Fusfeld Group*

Corinne Scown  
*Lawrence Berkeley  
National Laboratory*

Jean Scoyer  
*Scaron Consulting*

Charles Scozzie  
*Army Research Lab*

Richard Sears  
*Stanford University*



Mark Segal <i>EPA</i>	Thomas Speth <i>EPA</i>	Scott Tinker <i>Bureau of Economic Geology</i>
Robert Shaw <i>Aretê Corporation</i>	Siva Srinivasan <i>University of Florida</i>	Jessika Trancik <i>Massachusetts Institute of Technology</i>
Eric Shiff <i>DOE</i>	Ravi Srivastava <i>EPA</i>	Robert Tribble <i>Brookhaven National Laboratory</i>
David Shiffer <i>ONR</i>	Ed Steadman <i>UNDEERC</i>	Diane Turchetta <i>U.S. Department of Transportation</i>
Willy Shih <i>Harvard Business School</i>	John Sterling <i>Solar Electric Power Association</i>	Jason Turgeon <i>EPA</i>
Drew Shindell <i>Duke University</i>	Henrik Stiesdal <i>Siemens</i>	Paul Turinsky <i>North Carolina State University</i>
John Shingledecker <i>Electric Power Research Institute</i>	Bryce Stokes <i>AST</i>	Michael Ulsh <i>National Renewable Energy Laboratory</i>
Abhyankar Shrirang <i>Argonne National Laboratory</i>	Rob Stoner <i>Massachusetts Institute of Technology</i>	Baskar Vairamohan <i>EPRI</i>
Dale Simbeck <i>SFA Pacific</i>	Stephen Streiffer <i>Argonne National Laboratory</i>	Vicky VanZandt <i>Electric Transmission Consulting</i>
Karl Simon <i>EPA</i>	Ray Stults <i>National Renewable Energy Laboratory</i>	Ron Vance <i>EPA</i>
Gupreet Singh <i>DOE</i>	Tia Sutton <i>EPA</i>	Mark Verbrugge <i>General Motors</i>
Ramteen Sioshansi <i>The Ohio State University</i>	Jim Sweeney <i>Stanford University</i>	John Vetrano <i>DOE</i>
Wade Sisk <i>DOE</i>	Madhava Syamlal <i>National Energy Technology Laboratory</i>	Phil Vitale <i>U.S. Navy</i>
Charlie Smith <i>Utility Variable-Generation Integration Group</i>	Jeffrey Taft <i>Pacific Northwest National Laboratory</i>	Bill Vocke <i>USCG</i>
Merrill Smith <i>DOE</i>	Taro Takahashi <i>Columbia University</i>	Zia Wadud <i>University of Leeds</i>
Steve Smith <i>Pacific Northwest National Laboratory</i>	Lanetra Tate <i>NASA</i>	Marianne Walck <i>Sandia National Laboratories</i>
Shahab Sokhansanj <i>Oak Ridge National Laboratory</i>	Emmanuel Taylor <i>DOE</i>	Brian Walker <i>DOE</i>
Christopher Soles <i>NIST</i>	Mark Taylor <i>Corning Inc.</i>	Doug Wall <i>Sandia National Laboratories</i>
Arun Solomon <i>General Motors</i>	Kevin Teichman <i>EPA</i>	Doug Wall <i>Sandia National Laboratories</i>
Andrew Sowder <i>EPRI</i>	Steve Thomas <i>DOE</i>	Dan Walsh <i>NRECA</i>
Taylor Sparks <i>University of Utah</i>	Bob Thompson <i>EPA</i>	



Annie Wang  
*Senvol*

John Wang  
*Oak Ridge National  
Laboratory*

Haizhong Wang  
*Oregon State University*

Steve Wasserman  
*Eli Lilly & Co.*

Robert J. Wayland  
*EPA*

Melissa Weitz  
*EPA*

Christian Wetzel  
*Rensselaer Polytechnic  
Institute*

John Weyant  
*Stanford University*

Michael Whelan  
*Pipeline Research  
Council International*

Kate Whitefoot  
*National Academy of  
Engineering*

Susan Wickwire  
*EPA*

Angus Wilkinson  
*Georgia Institute of  
Technology*

Ellen Williams  
*DOE*

Robert Williams  
*Princeton University*

Jim Williams  
*E3*

Tracy Williamson  
*EPA*

Daryl Wilson  
*Hydrogenics*

Mary Wilson  
*WZI, Inc*

Paul Wilson  
*University of Wisconsin*

Bob Wimmer  
*Toyota Motor  
North America, Inc.*

Jamie Winebrake  
*Rochester Institute of  
Technology*

Ryan Wiser  
*Lawrence Berkeley  
National Laboratory*

Frank Wolak  
*FuelCell Energy*

Jetta Wong  
*DOE*

Frances Wood  
*OnLocation*

Margaret Wooldridge  
*University of Michigan*

Thomas Wunsch  
*Sandia National Laboratories*

Hongjun Yang  
*Semerane Inc.*

Jeff Yang  
*EPA*

George Q. Zhang  
*ABB*

Carl Zichella  
*Natural Resources  
Defense Council*

## Glossary

<b>ab initio</b>	From first principles. In science, a method is considered ab initio if it relies only on the established laws of nature and does not utilize assumptions or special models.
<b>aberration</b>	In optics, the failure of rays to converge at a single focus because of defects in a lens or mirror, leading to a blurring of the image produced. Similarly, in electron microscopy aberration leads to a blurring of the sample image, reducing the minimum attainable resolution.
<b>absorption heat transformer</b>	A device with the ability to raise the temperature of low or medium heat to higher, more useful temperature.
<b>additive manufacturing</b>	A class of processes that builds up objects by adding material, rather than using subtractive processes such as milling and machining. This is also known as 3D printing.
<b>advanced metering infrastructure</b>	Integrated system of smart meters, communications networks, and data management systems that enables two-way communication between utilities and customers.
<b>advanced ultra-supercritical</b>	Advanced ultra-supercritical (A-USC) pulverized coal power plants use steam cycle temperatures above 650°C (1202°F) to increase overall plant efficiency. USC steam temperatures are limited to approximately 627°C (1160°F) by the use of ferritic steels.
<b>albedo</b>	The fraction of incident light reflected from a surface, such as from the earth back into space.
<b>Alpha decay</b>	A mechanism of radioactive decay in which the radioisotope emits an alpha particle, undergoing a change to another element having a mass number reduced by four and an atomic number reduced by two.
<b>alpha emitter</b>	A radioisotope that undergoes alpha decay.
<b>alpha particle</b>	A helium nucleus, which contains two protons and two neutrons. It has an electric charge of +2, and an energy of approximately five megaelectron volts.
<b>alternating current</b>	An electric current that oscillates between positive and negative values at a fixed frequency.
<b>Archaea</b>	The biological kingdom of single celled organisms called prokaryotes having no cell nucleus or other membrane bound organelles.
<b>Atomic layer deposition</b>	A thin film deposition technique based on the sequential use of two (or more) gas phase chemicals (precursors) that react with a surface until all exposed sites are consumed (self-limiting). Through repeated exposure to each precursor, a thin film is deposited. In contrast to chemical vapor deposition, the precursors are never present at the same time.



<b>auxiliary loads</b>	The power required to power ancillary equipment in a power plant, such as fans and pumps.
<b>auxiliary power unit</b>	A device on a vehicle (truck, airplane, etc.) that provides power to start engines, run support equipment, or serve as backup power.
<b>B20</b>	A fuel composed of 80% petroleum based diesel fuel and 20% bio diesel that is typically made from soybean, canola, or other vegetable oils, animal fats, or recycled grease.
<b>balancing area</b>	A geographic segment of the electric power system in which electrical balance is maintained between resources and loads.
<b>base-load power plant</b>	A plant, usually housing high-efficiency steam-electric units, which is normally operated to take all or part of the minimum load of a system, and which consequently produces electricity at an essentially constant rate and runs continuously.
<b>beam emittance</b>	The properties of a particle beam in an accelerator, describing the size of the source and the divergence of the beam.
<b>biogenic</b>	Produced by biological processes of living organisms.
<b>biomass gasification with carbon capture and storage</b>	A power generation plant that gasifies biomass with the resulting synthetic gas used to fire a combined-cycle unit to produce electricity with the waste carbon dioxide being stored rather than vented to the atmosphere.
<b>biomass-to-liquids</b>	A process that converts biomass into a syngas which is then converted into liquid hydrocarbons.
<b>black start</b>	The process of restoring a power station to operation without relying on the external electric power transmission network.
<b>blowout preventer</b>	A piece of equipment used to control the flow of oil and gas from wells and prevent an uncontrolled release from the well.
<b>Brayton cycle</b>	A thermodynamic cycle that describes the workings of a constant pressure heat engine.
<b>British thermal unit</b>	The quantity of heat required to raise the temperature of one pound of liquid water by one degree Fahrenheit.
<b>burning plasma</b>	A condition wherein the energy produced by nuclear fusion within a confined plasma is sufficient to maintain the plasma temperature, i.e. the energy output is greater than the energy input.
<b>CAFE</b>	The Corporate Average Fuel Economy standard was first enacted by the U.S. Congress in 1975 and sets average fuel economy standards across a fleet of vehicles produced by an individual manufacturer.
<b>calutron</b>	A mass spectrometer used to separate the isotopes of an element.
<b>capacitor bank</b>	A passive electrical component used to improve the quality of power delivery by sourcing reactive power.
<b>capacity factor</b>	The ratio of the electrical energy produced by a generating unit for the period of time considered to the electrical energy that could have been produced at continuous full power operation during the same period.
<b>carbon capture and storage</b>	The process of capturing waste carbon dioxide from a source, such as fossil fuel power plants, and storing it where it will not enter the atmosphere.

<b>cascading effect</b>	A chain of events due to an initial disturbance that propagates across the system.
<b>catalyst</b>	A molecule or material that accelerates the rate of a chemical reaction without undergoing a permanent change itself. Catalysts exist either in the same phase (homogeneous) or a different phase (heterogeneous) relative to the reactant.
<b>central generators</b>	Centrally dispatched power-generating technologies that are connected to an electricity grid.
<b>chained dollars</b>	A measure used to express real prices. Real prices are those that have been adjusted to remove the effect of changes in the purchasing power of the dollar; they usually reflect buying power relative to a reference year.
<b>circuit breaker</b>	A critical component of the electric power system used to ensure safety and protection of assets by separating and isolating segments of the electric power system.
<b>clean energy manufacturing</b>	The manufacture of goods in a manner that reduces the environmental impacts associated with the manufacture, use, and/or disposal of the products.
<b>cloud condensation nuclei</b>	Small particles upon which water condenses that serve as the precursors to cloud formation.
<b>CO<sub>2</sub> equivalent</b>	A measure used to compare the emissions from various greenhouse gases based upon their global warming potential in units that are equivalent to that of carbon dioxide (CO <sub>2</sub> ).
<b>coal-to-liquids</b>	A process that converts coal into a syngas which is then converted into liquid hydrocarbons.
<b>co-design</b>	In science and engineering, a design methodology wherein the requirements of the problem to be solved are considered when designing the system that will be used to solve the problem.
<b>colossal magnetoresistance</b>	A property of some materials that enables them to dramatically change their electrical resistance in the presence of an external magnetic field.
<b>combined heat and power</b>	A power generating unit designed to produce both electricity and heat from a fuel source, increasing system efficiency.
<b>combined heat and power</b>	The concurrent production of electricity or mechanical power and useful thermal energy from a single energy input.
<b>compressed air energy storage</b>	The storage of compressed air in a container, usually an underground cavern, for later expansion through a turbine to generate electricity.
<b>compressed natural gas</b>	Natural gas compressed to a pressure at or above 200–248 bar (i.e., 2,900–3,600 pounds per square inch) and stored in high-pressure containers. It is used as a fuel for natural gas-powered vehicles.
<b>computational fluid dynamics</b>	A branch of fluid mechanics that uses computers to solve problems of fluid flow using numerical analysis and algorithms.
<b>computational manufacturing</b>	The use of computational tools such as modeling, simulation, and control systems to improve and regulate manufacturing processes or develop novel materials and products.



<b>concentrating solar power</b>	A solar energy conversion system characterized by the optical concentration of solar rays through an arrangement of mirrors to generate a high-temperature working fluid that is then used in a steam or gas turbine to generate electricity.
<b>conservation voltage reduction</b>	A strategy to reduce energy consumption by reducing the voltage along distribution feeders while staying within limits needed for equipment to operate properly.
<b>core damage frequency</b>	An expression of the likelihood that, given the way a reactor is designed and operated, an accident could cause the fuel in the reactor to be damaged.
<b>critical material</b>	A material of high economic importance that is at risk of supply disruption due to challenges such as a small global market, lack of supply diversity, or geopolitical risk.
<b>cycle life</b>	The number of charge/discharge cycles that a battery is able to support for a given depth-of-discharge within its useful life.
<b>day ahead markets</b>	Forward electricity markets where participants commit to buy or sell wholesale electricity a day in advance to help avoid price volatility.
<b>demand controlled ventilation</b>	A system which automatically adjusts the operation of ventilation equipment, either through a timed schedule or occupancy sensors, to meet ventilation requirements.
<b>demand-side management</b>	Utility programs that incentivize consumers to shift electricity use away from periods of peak demand (e.g., via load shifting), and to reduce electricity use overall (e.g., via energy efficiency).
<b>density functional theory</b>	A computational quantum mechanical modeling method used to simulate the electronic structure of many-body systems.
<b>depth-of-discharge</b>	A method to indicate a battery's state of charge, where 100% is empty.
<b>diffraction</b>	The process by which incident particles (photons, electrons, protons, neutrons, ions) interact with a periodic structure to produce a characteristic interference pattern. This interference pattern can be used to determine structural properties of a material.
<b>dimethyl ether</b>	A colorless gas that can be produced from natural gas or biomass and can be used as a substitute for liquefied petroleum gas for cooking or industrial uses or as a motor fuel in diesel engines with relatively minor modifications.
<b>direct current</b>	An electric current that flows in one direction.
<b>direct energy conversion</b>	Devices or systems that convert energy from one form to another without intermediate steps.
<b>dispatchable demand resources</b>	Customer demand that can be reduced in response to the utility or grid operator direction to address electricity system peak demand or supply constraints in exchange for a reduction in their electricity bills.
<b>distributed energy resources</b>	Small, modular technologies that can provide electricity or energy services, such as distributed generation and energy storage, that can be placed throughout the grid but typically near customer loads.
<b>distributed generation</b>	A variety of small, modular power-generating technologies that can be placed throughout the grid, particularly on distribution systems. (Note that they do not necessarily have to be combined with storage, etc., and don't necessarily get used to improve operations.)

<b>distribution feeder</b>	Power lines connected to a distribution substation to deliver electricity to customers.
<b>distribution system</b>	The lower voltage portion of the electricity delivery system used to connect supplies, typically from transmission, and distribute it to individual customers in a more confined geographic region.
<b>duck curve</b>	A graphical representation of the net-load curve (total load minus the amount produced by variable generation such as solar) projected for the California Independent System Operator demonstrating the increased need for system flexibility to meet steep ramps.
<b>E15</b>	A fuel containing a mixture of 15 percent ethanol and 85 percent gasoline.
<b>E85</b>	A fuel containing a mixture of 85 percent ethanol and 15 percent gasoline.
<b>edge localized mode</b>	A sudden, intense burst of heat that erupts from the edge of a plasma magnetically confined in a Tokamak fusion device.
<b>electric drive technologies</b>	Technologies that provide propulsion for electric drive vehicles and include power electronics and electric motors.
<b>electric vehicle supply equipment</b>	Equipment that increases the safety and ease of charging electric vehicles by enabling two-way communication between the vehicle and charger.
<b>electric vehicles</b>	A vehicle powered by electricity stored in batteries.
<b>electricity architecture</b>	The collection of relationships, connectivity, interactions, and structures that make up the electric power system spanning the physical, cyber, and human domains.
<b>electrolysis</b>	A process that uses electricity to split water into hydrogen and oxygen.
<b>electron microscopy</b>	A type of microscope that uses a beam of electrons to create an image of a specimen. Due to the very small wavelength of the electron, electron microscopes have much higher resolving power relative to a light microscope, revealing much finer detail of objects.
<b>electron volt</b>	An empirically-derived unit of energy defined as the amount of energy gained or lost by an electron moved across an electrical potential of one volt. It is approximately equal to $1.6 \times 10^{-19}$ joules. It is often expressed in metric multiples (e.g., milli [m], mega [M] or giga [G]).
<b>electronic converter</b>	A technology based on semiconductor devices that change the characteristics of electric power, altering voltage levels or converting between alternating current and direct current.
<b>embodied energy</b>	The energy required to build or manufacture a device or structure, including the energy used to produce the materials in that device or structure.
<b>energy services</b>	Services made possible by energy use such as transportation, heating, light, etc.
<b>energy surety</b>	A guarantee of desired energy system attributes such as safety, security, reliability, sustainability, and cost effectiveness.
<b>enhanced geothermal systems</b>	An enhanced geothermal system is one which creates porosity in hot rock to allow the extraction of heat to drive power generation.
<b>enhanced oil recovery</b>	Techniques that use water, steam, chemical, carbon dioxide flooding, etc., to produce greater amounts of the original oil in a reservoir than would be producible by conventional techniques.



<b>enthalpy</b>	The amount of heat content used or released in a system at constant pressure.
<b>enzyme</b>	A macromolecule that acts as a catalyst for complex biological reactions.
<b>exascale</b>	A term representing a level of computer performance equal to or greater than 1,000 petaflops.
<b>experience curve analysis</b>	A method of projecting the reduction in technology costs over time, usually as a function of increasing volume of production, improvement in manufacturing processes, learning by doing, etc. External factors such as policy or other technology changes can also play a role.
<b>expert elicitation</b>	The use of experts familiar with a technology to supply subjective probability distributions of projected economic, technical, or other characteristics at some future date. Such a method can be used to provide risk and uncertainty estimates in technology forecasts.
<b>fair-weather bias</b>	A potential bias in results due to examining only clear sky conditions.
<b>Fischer-Tropsh</b>	A process that converts a feedstock such as natural gas or coal into a syngas, which is then converted into liquid hydrocarbons.
<b>flaring</b>	The controlled combustion of flammable gases at a refinery or at a wellhead. Often natural gas is flared as a result of the unavailability of a method for transporting such gas to markets.
<b>flexible AC transmission systems</b>	An electronic-based system used to help control of key AC transmission system parameters and increase power transfer capability.
<b>flexible decision making</b>	An approach that considers the full uncertainty in future value, and focuses on potential value if projects or technologies are successful. It relies upon iterative follow-on investment decisions that do not require large outlays of funding at early stages, to reduce uncertainty and increase rate of success.
<b>flexible generators</b>	A electric power generation unit that is readily available and under the direct control of the operator with the ability to change output levels.
<b>flux</b>	The rate of flow of a physical property per unit area.
<b>free-electron laser</b>	The use of very-high speed electrons moving through a regular alternating magnetic structure (undulator) to generate lasing with high peak brilliance. The radiation emitted is widely tunable, from microwave to X-ray band, by adjusting the energy of the electrons or the magnetic field strength of the undulator.
<b>fuel cell</b>	A device that produces electricity through an electrochemical process, usually from hydrogen or from methane, with oxygen, etc.
<b>fuel scheduling</b>	The scheduling of fuel supply for individual generators.
<b>functional annotation</b>	The process of attaching biological information to genomic elements including biochemical function, biological function, regulation, and expression.
<b>gamma radiography</b>	The use of gamma ray photons to image the internal structure of an opaque object.
<b>gas-cooled fast reactor</b>	A next generation reactor that uses helium as a coolant and relies on high-energy "fast" neutrons.



<b>gene expression</b>	The process by which the information contained in a gene is used to synthesize a functional gene product (RNA or protein). Overexpression of a gene results in the synthesis of too many copies of the functional product.
<b>Generation III+ reactor</b>	An advanced, third-generation light water reactor that incorporate new features such as improved safety features and standardized design.
<b>genome</b>	The complete set of DNA, including all of its genes, necessary to build and maintain an organism.
<b>geoengineering</b>	The deliberate, large-scale modification of the earth's natural systems.
<b>geothermal power</b>	Geothermal power uses heat from underground to generate electricity, heat buildings, or for other purposes.
<b>gigabit</b>	A multiple ( $10^9$ ) of the bit, the basic unit of digital information storage, having one of two values (zero or one).
<b>gigaton</b>	One billion metric tons
<b>gigawatt</b>	One billion watts or one thousand megawatts (also GW)
<b>gross domestic product</b>	The total value of goods and services produced by labor and property located in a country.
<b>heat island</b>	An urban area characterized by temperatures higher than those of the surrounding non-urban area. As urban areas develop, buildings, roads, and other infrastructure replace open land and vegetation. These surfaces absorb more solar energy, which can create higher temperatures in urban areas.
<b>heat pump</b>	Technologies that move thermal energy opposite to the direction of normal heat flow, such as by absorbing heat from a cold area and transferring it to a warmer one. During the heating season, heat pumps move heat from the cool outdoors into the warm indoors and during the cooling season, heat pumps move heat from the cool indoors into the warm outdoors.
<b>hierarchical control</b>	A classification of coordination and control of generators and other power system assets based on a top-down relationship.
<b>high-temperature superconductor</b>	A material that shows superconductivity (i.e., zero electrical resistance) at temperatures much higher than traditional superconductors.
<b>higher heating value</b>	The value of the heat of combustion of a fuel that takes into account the heat of vaporization of water.
<b>high-performance computing</b>	The practice of achieving high computing power through massive parallelization of processors to solve very complex problems.
<b>homogeneous charge compression ignition</b>	A type of internal combustion engine process where a well-mixed combination of fuel and air are compressed to the point of ignition without using a spark plug or fuel injector to initiate combustion.
<b>horizontal drilling</b>	A drilling technique where the drill is directed horizontally.
<b>hybrid electric vehicles</b>	A vehicle in which a power plant (e.g., internal combustion engine or fuel cell) powers an electric propulsion system, either exclusively or in parallel with a mechanical drivetrain.



<b>hydraulic fracturing</b>	Fracturing of rock at depth with fluid pressure to increase rock porosity. Hydraulic fracturing at depth may be accomplished by pumping water into a well at very high pressures which can then enable oil or gas production from an otherwise bound source or enable flow of water through a thermal reservoir for geothermal energy production. Under natural conditions, vapor pressure may rise high enough to cause fracturing in a process known as hydrothermal brecciation.
<b>hydrodynamics</b>	A field of physics that deals with the motion of fluids and the forces acting on objects immersed in fluids.
<b>hydropower</b>	The use of flowing water to produce electrical energy.
<b>induced seismicity</b>	Earthquake activity that results from human activity such as the subsurface injection of fluid at a rate or pressure such that the rock is caused to move along a pre-existing fault plane.
<b>inductor bank</b>	A passive electrical component used to improve the quality of power delivery by sinking reactive power.
<b>information and communication technology network</b>	An integrated system of telecommunications, computer networks, and software that enable users to access, store, transmit, and manipulate information.
<b>Integrated Assessment Model</b>	Scientific modeling most often used for environmental analysis that integrates multiple academic disciplines.
<b>integrated gasification combined cycle</b>	A power generation plant that gasifies coal with the resulting synthetic gas used to fire a combined-cycle unit to produce electricity.
<b>interchange scheduling</b>	The scheduling of energy exchange between grid control areas.
<b>interferometer</b>	A measurement device that superimposes electromagnetic waves in order to extract information about the waves via their interference (constructive or destructive) with one another. Typically one of the waves interacts with an object that modifies the wave, thereby providing information about the properties of the interacting object.
<b>intermediate-load power plant</b>	A plant that is normally operated to follow load as it changes through the day.
<b>interval meter</b>	An electrical meter that records power consumption over periodic intervals.
<b>isotope</b>	A variant of an element differing in the number of neutrons (the atomic mass), but not the number of protons (the atomic number).
<b>kilowatt</b>	One thousand watts (also kW)
<b>kilowatt-hour</b>	A measure of electricity defined as a unit of work or energy, measured as one kilowatt (1,000 watts) of power expended for one hour. One kilowatt-hour (kWh) is equivalent to 3,412 British thermal units (also kWh).
<b>large-eddy simulation</b>	A mathematical model of turbulence used in computational fluid dynamics to simulate, for example, combustion, acoustics, and turbulence.
<b>lead-cooled fast reactor</b>	A next generation reactor that uses lead-bismuth eutectic as a coolant and relies on high energy "fast" neutrons.

<b>levelized cost of energy</b>	A metric of the total cost of energy (most often applied to electricity) production divided by the asset lifetime, and includes capital depreciation, fixed and variable operations and maintenance, fuel costs, and potentially other costs or credits (such as carbon offsets).
<b>life cycle</b>	All stages of a product's life, from raw materials extraction to manufacturing, use, and final disposal or recycling.
<b>life-cycle assessment</b>	A methodology that assesses the energy, materials and potentially other inputs, outputs, and impacts of a product or process. The assessment spans the entire useful life, from raw material extraction through end-of-life management (repurposing, recycling or disposal).
<b>light-emitting diodes</b>	A semiconductor that emits light when an electric current passes through it.
<b>light water reactors</b>	A nuclear reactor that uses water as the primary coolant and moderator, with slightly enriched uranium as fuel.
<b>light-duty vehicles</b>	Vehicles weighing less than 8,500 pounds (including automobiles, motorcycles, and light trucks).
<b>lignocellulosic biomass</b>	Plant dry matter (biomass) composed of carbohydrate polymers (cellulose, hemicellulose) tightly bound to an aromatic polymer (lignin).
<b>lipid</b>	An organic compound comprised of fatty acids that are insoluble in water.
<b>liquefied natural gas</b>	Methane that has been changed from gas phase to liquid phase as a result of a reduction of temperature or an increase in pressure or a combination of both.
<b>liquefied petroleum gas</b>	A group of hydrocarbon gases, primarily propane, normal butane, and isobutene, derived from crude oil refining or natural gas processing.
<b>low temperature combustion</b>	A term that covers a number of advanced combustion technologies that reduce nitrogen oxide and particulate emissions.
<b>lower heating value</b>	The value of the heat of combustion of a fuel that does not take into account the heat energy put into the vaporization of water (heat of vaporization).
<b>lumen</b>	An empirical measure of the quantity of light. It is based upon the spectral sensitivity of the photosensors in the human eye under high (daytime) light levels.
<b>magnetic resonance spectroscopy</b>	A measurement technique that exploits the quantized spin of an atomic nucleus (nuclear magnetic resonance spectroscopy) or electron (electron paramagnetic resonance spectroscopy) to interrogate the physical and chemical properties of a system.
<b>marine and hydrokinetic power</b>	Power generation using the energy of waves, tides, and river and ocean currents.
<b>mass spectrometry</b>	An analytical technique used to identify the amount and type of chemical species in a sample by measuring the mass-to-charge ratios.
<b>material criticality</b>	A designation of materials that are most important to the economy and are at risk of supply disruption.
<b>Materials Genome Initiative</b>	A multiagency initiative to improve the process for discovering, developing, and manufacturing advanced materials through advanced computational capabilities, data management, and integrated engineering, with a goal of developing advanced materials twice as fast and at a fraction of the cost of conventional approaches.
<b>megawatt-hour</b>	One thousand kilowatt-hours or one million watt-hours (also MWh)



<b>megawatt</b>	One million watts of electricity (also MW)
<b>mesoscale</b>	The length scale between the nanoscale and the macroscale (approximately 100 to 1,000 nanometers), where the properties of bulk objects, defined by classical mechanics, emerge from properties of the atomic and molecular components, defined by quantum mechanics.
<b>metabolic pathway</b>	A series of connected biochemical reactions occurring within a cell.
<b>metal organic framework</b>	Compounds consisting of metal atoms or clusters linked by organic molecules to form one-, two-, or three-dimensional structures that typically have very high internal surface area.
<b>methanol</b>	A light, volatile alcohol ( $\text{CH}_3\text{OH}$ ) that can be blended with gasoline or used directly as a motor fuel. It is used as a fuel for many motor racing events.
<b>metrology</b>	The science of measurement, embracing both experimental and theoretical determinations at any level of uncertainty in any field of science and technology.
<b>microbial dark matter</b>	The unseen majority of microbial life that is not currently amenable to laboratory cultivation and therefore direct study by observation.
<b>molten carbonate fuel cell</b>	A type of fuel cell that contains a molten carbonate electrolyte. Carbonate ions ( $\text{CO}_3^{2-}$ ) are transported from the cathode to the anode. Operating temperatures are typically near $650^\circ\text{C}$ .
<b>N-1 reliability criteria</b>	A bulk power system operating and planning criteria to ensure reliability in the event of a single contingency such as the loss of a large power plant or transmission line.
<b>nanoscale</b>	Structures having a length scale of approximately 1-100 nanometers. One nanometer is $10^{-9}$ meters.
<b>nanoscience</b>	The multidisciplinary study of structures and materials at the nanoscale.
<b>nanotechnology</b>	The manipulation of matter on an atomic, molecular, and supramolecular scale.
<b>natural gas hydrates</b>	Cage-like lattice of ice inside of which are trapped molecules of methane, the chief constituent of natural gas; also referred to as methane hydrates.
<b>nuclear fusion</b>	A reaction wherein two or more atoms collide and combine to create a new, heavier element. For elements lighter than iron, this process releases energy.
<b>ocean acidification</b>	The ongoing decrease in ocean pH levels due to the uptake of increased levels of carbon dioxide in the earth's atmosphere.
<b>ome</b>	In biology, the totality of objects within a given field of study, e.g. genome (the genetic material of an organism), proteome (the collection of proteins expressed by a genome), metabolome (the complete set of small molecule chemicals found within an organism), or transcriptome (the set of RNA molecules in an organism).
<b>omics</b>	An informal term referring to any field of biology ending in “-omics”, (e.g., genomics, proteomics, or metabolomics).
<b>options space analysis</b>	A method of comparing a set of technologies that contribute to a particular desired service in a specific sector (such as transportation) across a range of characteristics and trade-offs.

<b>organic aerosol</b>	A material comprised of a gaseous suspension of microscopic solid or liquid particles composed of organic matter. A secondary organic aerosol is particulate matter composed of compounds formed from the atmospheric transformation of organic species.
<b>particle accelerator</b>	A device capable of accelerating charged particles to high energies using electromagnetic fields.
<b>peak load</b>	The maximum electric load during a specified period of time for a given power system.
<b>peaking power plant</b>	A power plant, typically gas turbines, diesels, or pumped-storage hydroelectric, normally used during the peak-load periods.
<b>petaflop</b>	A trillion flop, or floating point operations per second, a measure of computer performance.
<b>phase angle</b>	The difference in timing between when the voltage peaks and when the current peaks for alternating current at a given point in the electric power system.
<b>phasor management unit</b>	A device which measures the voltage, current, and phase at a point on the electrical grid that uses a common time source for synchronization; also known as a synchrophasor.
<b>phosphor</b>	Generally, a substance that exhibits luminescence.
<b>phosphoric acid fuel cell</b>	A type of fuel cell in which the electrolyte consists of concentrated phosphoric acid ( $\text{H}_3\text{PO}_4$ ). Protons ( $\text{H}^+$ ) are transported from the anode to the cathode. The operating temperature range is generally $160^\circ\text{C}$ – $220^\circ\text{C}$ .
<b>photoelectrochemical water splitting</b>	A process where hydrogen is produced from water using sunlight and specialized semiconductors called photoelectrochemical materials, which use light energy to directly dissociate water molecules into hydrogen and oxygen.
<b>photoelectrodes</b>	A semiconducting electrode in a photoelectrochemical cell that, when impinged by a photon, creates a negatively charged electron and a positively charged hole that are used at the surface of the cathode and anode, respectively, to perform chemical reduction and oxidation, respectively.
<b>photoionization</b>	Ionization of an atom or molecule produced as a result of interaction with electromagnetic radiation.
<b>photosynthesis</b>	The process by which plants and other organisms use light to convert water and carbon dioxide into chemical energy that fuels the activities of the organism and, most commonly, oxygen.
<b>photovoltaic</b>	An electronic device consisting of layers of semiconductor materials fabricated to form a junction (adjacent layers of materials with different electronic characteristics) and electrical contacts and being capable of converting incident light directly into electricity.
<b>photovoltaic effect</b>	The creation of a voltage or electric current in a material exposed to light.
<b>photovoltaics</b>	The method of converting solar energy into usable electrical energy using semiconducting materials that exhibit the photovoltaic effect.
<b>phylum</b>	In biology, a taxonomic rank, below kingdom and above class, wherein a group of organisms are defined as having a “certain degree” of morphological or developmental similarity, or a “certain degree” of evolutionary relatedness.



<b>piezoelectricity</b>	A property of certain solid materials to internally accumulate electrical charge when mechanically stressed.
<b>plasma</b>	An aggregate state of matter comprised of ionized atoms and their free electrons.
<b>plasma wakefield acceleration</b>	A method for accelerating charged particles to very high energy over relatively short distances by creating a charge wake in a plasma using high energy electrons or a laser pulse.
<b>platinum group metals</b>	A group of metals with similar physical and chemical properties to platinum. They are iridium, osmium, palladium, platinum, rhodium and ruthenium. Common uses in vehicles are for emissions control and fuel cell catalysis.
<b>plug-in electric vehicles</b>	A hybrid electric vehicle with batteries that can also be recharged by an external electricity source.
<b>plug-in hybrid electric vehicles</b>	A vehicle that combines a conventional internal combustion engine with an electric propulsion system with batteries that can also be recharged by an external electricity source.
<b>plug-loads</b>	The energy used by equipment using an electric outlet.
<b>point sources</b>	Any discernible, confined, and discrete source of pollutants.
<b>polarization</b>	A property of electromagnetic radiation that describes the constrained set of orientations of the electric or magnetic field vector. Examples include linear and elliptical. Polarization results from the fact that light behaves as a two-dimensional transverse wave.
<b>polygeneration</b>	A process with three or more energy outputs such as electricity, fuel, and heat.
<b>polymer electrolyte membrane fuel cell</b>	A type of acid-based fuel cell in which the transport of protons (H+) from the anode to the cathode is through a solid, aqueous membrane impregnated with an appropriate acid. The electrolyte is called a polymer electrolyte membrane. The fuel cells typically run at low temperatures (<100°C).
<b>portfolio analysis</b>	A time-dependent system of relationships among competing and complementary energy technologies, the larger energy system, the economy, land use, water, atmospheric composition, and climate.
<b>power use effectiveness</b>	A measure of efficiency for computer data centers. It is calculated as the total facility power consumption divided by the power consumed by the computer equipment.
<b>pre-mixed charge compression ignition</b>	A technique where the fuel, air, and some exhaust gas are mixed before compression and ignition.
<b>primary energy</b>	Energy in the form that it is first accounted for in a statistical energy balance, before any transformation to secondary or tertiary forms of energy.
<b>process intensification</b>	Any technique or apparatus, especially in the chemicals sector, that reduces equipment size and complexity, energy consumption, and/or the environmental impacts of manufacturing processes.
<b>prosumer</b>	A consumer of electric power that can also produce it.
<b>pumped hydro storage</b>	A technology that uses electricity to pump water into an elevated reservoir to store energy and runs the water through a hydroelectric turbine to release energy.
<b>pyrolysis</b>	The decomposition of biomass at high temperatures in the absence of oxygen. It can be used to generate syngas or pyrolysis oils, etc.

<b>quads</b>	Quadrillion British thermal units
<b>radial lines</b>	A classification of the way a conventional electricity distribution system is typically connected to deliver electricity.
<b>radiative transfer</b>	The physical phenomenon of energy transfer via absorption, emission, and scattering as electromagnetic radiation travels through a medium.
<b>radical</b>	A typically highly reactive chemical species (atom, molecule, ion) having an unpaired valence electron.
<b>ramp rates</b>	The rate that a source of electric power can change its output.
<b>rare earth material</b>	A class of seventeen elements in the periodic table, specifically the fifteen lanthanides (lanthanum through lutetium) plus scandium and yttrium.
<b>reactivity controlled compression ignition</b>	A variant of homogeneous charge compression ignition where a higher reactivity fuel is combined with a premixed mixture of a lower reactive fuel, air and exhaust gases.
<b>reflectometry</b>	A non-destructive experimental technique used to probe the properties of a medium by measuring the energy reflected when the wave encounters a material interface different from the initial medium.
<b>reliability (electric grid)</b>	A measure of power system performance; the ability to continue meeting electricity demands.
<b>reserve requirements</b>	The amount of excess available capability of an electric power system over the projected peak load for a utility system that act as a back up in case of an unexpected outage of an operating generation unit.
<b>residual oil zone</b>	Areas of immobile crude oil below the oil-water contact zone.
<b>resilience</b>	The ability of the electric power system to withstand minor disturbances, mitigate the impact of major disturbances, and recover to normal operations after disturbances.
<b>roll-to-roll processing</b>	A class of substrate-based manufacturing processes in which additive and subtractive processes are used to build structures in a continuous manner. Typical roll-to-roll operations include casting, extrusion, coating, and printing of two-dimensional processes.
<b>round-trip efficiencies</b>	The percentage of energy that can be retrieved after it has been stored.
<b>R-Value</b>	A measure of a material's resistance to heat flow in units of Fahrenheit degrees x hours x square feet per Btu. The higher the R-value of a material, the greater its insulating capability.
<b>scintillation</b>	The emission of light from a material upon absorption of radiation, for example a photon, electron, ion, or neutron.
<b>semiconductor</b>	An elemental or compound material having electrical conductivity between that of a conductor and an insulator.
<b>small angle neutron scattering</b>	An experimental technique wherein incident neutrons are elastically scattered (i.e., the energy of the incident and scattered electrons are the same) at small (0.1-10°). angles from the sample, enabling structural analysis at mesoscopic length scales (1-100 nanometers).
<b>small modular reactors</b>	Nuclear power plants that smaller in size than conventional nuclear power plants. Typically, they are 300 MWe or less in capacity.



<b>smart grid technologies</b>	A category of technologies that improve the monitoring, analysis, and control of the grid, leveraging advances in information and communication technologies.
<b>sodium-cooled fast reactor</b>	A next generation reactor that uses liquid metallic sodium as a coolant and relies on high-energy "fast" neutrons.
<b>solar thermochemical hydrogen</b>	A thermochemical process for extracting hydrogen from water using concentrated sunlight as the heat source.
<b>solid oxide fuel cell</b>	A type of fuel cell in which the electrolyte is a solid, nonporous metal oxide with temperatures of operation typically 800°C-1000°C.
<b>solid-state distribution transformer</b>	A technology that combines high-powered semiconductor devices with the function of a conventional distribution transformer to provide new capabilities.
<b>solid-state lighting</b>	Refers to lighting using light-emitting diodes, which are semiconductors that emit light when an electric current passes through them.
<b>spallation</b>	A process by which neutrons and other particles are ejected from a heavy metal target due to impacts from a high-energy particle beam.
<b>spectral lines</b>	The discrete energies in an otherwise continuous spectrum that are absorbed or emitted by an atom or molecule and that are characteristic of that atom or molecule.
<b>state variable</b>	One of a set of variables used to describe the mathematical state of a dynamical system.
<b>state-of-charge window</b>	An indicator of the remaining charge in the batteries for hybrid electric vehicles, plug-in hybrid electric vehicles, and electric vehicles.
<b>steam methane reforming</b>	A method for producing hydrogen, carbon monoxide, or other useful products by reacting high-temperature steam with natural gas.
<b>stochastic optimization</b>	The minimization (or maximization) of a function in the presence of randomness in the optimization process.
<b>storage ring</b>	A circular particle accelerator capable of storing a continuous or pulsed particle beam (typically protons, electrons, or positrons) for long periods of time. Typically used to store electrons that produce synchrotron radiation for an X-ray light source or in a particle collider where two counter rotating stored particle beams are collided at discrete locations.
<b>superconducting magnetic energy storage</b>	A device that stores electric energy in a magnetic field generated from a direct current circulating in a superconducting coil.
<b>superconducting radiofrequency</b>	The science and technology of applying electrical superconductors to radiofrequency technology. When used to build an RF cavity, the negligible electrical resistance of the superconducting material leads to cavities capable of storing energy with almost no loss and very narrow bandwidth.
<b>superconductor</b>	A material that exhibits no electrical resistance below a characteristic temperature.
<b>supercritical fluid</b>	A substance at a temperature and pressure above its critical point, where distinct liquid and gas phases do not exist.
<b>supervisory control and data acquisition systems</b>	A technology used to monitor and control equipment and systems remotely.



<b>sustainability analysis</b>	A methodology that looks at the environmental, life-cycle, climate, and other impacts of different technologies.
<b>sustainable manufacturing</b>	The creation of manufactured products through economically-sound processes that minimize environmental impacts while conserving energy and natural resources.
<b>synchronous generator</b>	A classification of electric power generators that converts mechanical energy into alternating current where the frequency of the output is synchronized with the speed of the rotor.
<b>synchrotron radiation</b>	Electromagnetic radiation produced as a result of very high speed (relativistic) charged particles being accelerated in a curved path.
<b>synthetic biology</b>	An interdisciplinary branch of biology that is focused on the design and construction of new biological parts, devices, and systems, and the modification of existing, natural biological systems for useful purposes.
<b>system congestion</b>	A condition that occurs when there is insufficient available transfer capacity on an electric grid to implement all of the preferred schedules for electricity transmission simultaneously.
<b>Système International</b>	The International System of Units (Système International d'Unités), the modern form of the metric system, comprises a coherent system of units of measurement built on seven base units, used to define twenty-two named units and derive many more unnamed units.
<b>systems biology</b>	The study of the complex interactions between biological components, for example molecules, cells, organisms, or species.
<b>Technology Readiness Levels</b>	A method of estimating technology maturity and uses a scale from 1 (basic science) to 9 (mature technology).
<b>technology roadmapping</b>	A methodology to provide information to inform technology decision-making by identifying technologies and gaps, tracking performance of technologies, and identifying opportunities to leverage RDD&D investments.
<b>terawatt-hour</b>	One trillion watt-hours (also TWh)
<b>tesla</b>	The Système International (SI) derived unit of magnetic flux density.
<b>thermal energy storage system</b>	A technology where thermal energy is stored in a medium such as molten salt, that can be later used to power a turbine to produce electricity, or in ice, that can be later used to offset air conditioning needs.
<b>thermochemical</b>	The chemistry of heat and heat-assisted chemical reactions.
<b>thermodynamic limit</b>	The upper limit on conversion efficiency for turning heat energy into useful work.
<b>thermoelectric generators</b>	Devices that can convert heat differentials in a material directly into electricity through the Seebeck effect.
<b>tight oil (gas)</b>	Oil (natural gas) produced from petroleum-bearing formations with low permeability such as the Eagle Ford, the Bakken, Haynesville, and other formations that must be hydraulically fractured to produce oil (natural gas) at commercial rates. Shale oil (natural gas) is a subset of tight oil (natural gas).
<b>Tokamak</b>	A device capable of confining a plasma using magnetic fields in the shape of a torus. It is a type of magnetic confinement device being explored for harnessing thermonuclear fusion as a power source.
<b>tomography</b>	The process of imaging a 3D object by sections using a penetrating wave.



<b>transactive energy</b>	An advanced control and coordination concept to manage the generation, consumption, or flow of electric power within an electric power system through the use of economic or market-based constructs while considering grid reliability constraints and other objectives.
<b>transformer</b>	A component of the electric power system used to change the voltage of alternating current.
<b>transmission</b>	The high voltage portion of the electricity delivery system used to connect electric suppliers to demand centers across large geographic regions.
<b>transmission electron microscopy</b>	An imaging technique in which a beam of electrons passes through and interacts with an ultra-thin sample, providing atomic-scale resolution of the material structure.
<b>transporter protein</b>	A protein in an organism that functions to move material from one place to another.
<b>transuranic element</b>	An element having an atomic numbers greater than that of uranium (92). Such elements are also sometimes referred to as super-heavy elements.
<b>tribology</b>	The science and technology of interacting surfaces, usually considering the friction and wear between them, and the processes of lubrication.
<b>tritium</b>	A rare, radioactive isotope of hydrogen having one proton and two neutrons in its atomic nucleus.
<b>troposphere</b>	The lowest layer of the earth's atmosphere.
<b>unconventional oil and gas</b>	An umbrella term that refers to resources such as shale gas, shale oil, tight gas, and tight oil that cannot be produced economically through standard drilling and completion practices.
<b>unit commitment</b>	An optimization problem used to determine the operation schedule of individual generators to meet varying loads under different constraints and environments.
<b>variable frequency drive</b>	An adjustable speed motor system that uses changes in electric frequency and voltage to manage motor speed and torque based on application demand.
<b>variable generators</b>	An electric power generation unit whose output changes with time due to factors outside the direct control of the operator, such as wind or solar energy.
<b>vehicle-to-building</b>	A system that allows the electricity stored in a plug-in hybrid electric vehicle, hybrid electric vehicle, or fuel cell electric vehicle (with hydrogen as electricity precursor) to be utilized by a building during periods of high demand or power outage.
<b>vehicle-to-grid</b>	A system that allows the electricity stored in a plug-in hybrid electric vehicle, hybrid electric vehicle, or fuel cell electric vehicle (with hydrogen as electricity precursor) to be utilized by the power grid during periods of high demand.
<b>volt/VAR optimization</b>	An advanced grid application that optimizes voltage profiles and reactive power flows in distribution systems to achieve a variety of objectives.
<b>voltage collapse</b>	An undesirable condition of the electric power system where there is a loss in stability and a blackout occurs when system voltages decrease catastrophically.
<b>waste heat recovery</b>	The capture and useful application of energy that would otherwise be rejected to the environment as waste heat.

<b>watt</b>	The Système International (SI) unit of power, defined as one joule per second.
<b>wedge analysis</b>	A framework for comparing different climate change mitigation activities on the basis of their greenhouse gas reduction potential represented as “wedges.”
<b>wide bandgap semiconductors</b>	A semiconductor that has a bandgap of typically three electron volts or more, compared to silicon with a bandgap of 1.1 electron volts. This larger bandgap enables a semiconductor device using this material to operate at much higher voltages, frequencies, and temperatures than silicon-based devices, allowing more powerful electronic devices to be built.
<b>wind turbine</b>	Wind energy conversion device that produces electricity; typically three blades rotating about a horizontal axis and positioned up-wind of the supporting tower.

\* The definitions provided in this glossary are specifically for the context in which these terms are used within the Quadrennial Technology Review 2015. In other contexts, these terms may be used differently. A variety of sources were referenced in the development of this glossary, including: “Glossary.” U.S. Energy Information Administration, 2015, <http://www.eia.gov/tools/glossary/>; “Glossary of Energy-Related Terms.” U.S. Department of Energy Office of Energy Efficiency and Renewable Energy, 2015, <http://energy.gov/eere/energybasics/articles/glossary-energy-related-terms>; and many other public sources.



## Acronyms

<b>\$/km</b>	dollars per kilometer	<b>ASCPMM</b>	advanced sensors, controls, platforms and modeling for manufacturing
<b>\$/kWh</b>	dollars per kilowatt-hour	<b>ASAI</b>	average service availability index
<b>\$/MJ</b>	dollars per megajoule	<b>ASTA</b>	Advanced Superconducting Test Accelerator
<b>\$/MMBtu</b>	dollars per million British thermal units	<b>ASTM</b>	American Society for Testing and Materials
<b>3D</b>	3-dimensional	<b>ATF</b>	Accelerator Test Facility
<b>AC</b>	alternating current	<b>ATLAS</b>	Argonne Tandem Linac Accelerator System
<b>ACCEL</b>	Accelerating Competitiveness through Computational Excellence Program	<b>AUSC</b>	advanced ultra-super critical
<b>ACTT</b>	Advanced Computing Tech Team	<b>AV</b>	automated vehicle
<b>AM</b>	additive manufacturing	<b>AWAF</b>	Argonne Wakefield Accelerator Facility
<b>AEO</b>	Annual Energy Outlook (of the EIA)	<b>BAU</b>	business-as-usual
<b>AEP</b>	annual energy production	<b>BECCS</b>	bioenergy with carbon capture and storage
<b>AER</b>	all-electric range	<b>BELLA</b>	Berkeley Lab Laser Accelerator Center
<b>AERI</b>	atmospheric emitted radiance interferometers	<b>BES</b>	U.S. DOE Office of Basic Energy Sciences
<b>AHT</b>	absorption heat transformer	<b>BESAC</b>	Basic Energy Sciences Advisory Committee
<b>Al</b>	aluminum	<b>BESC</b>	BioEnergy Science Center
<b>ALCC</b>	ASCR Leadership Computing Challenge	<b>BGCCS</b>	biomass gasification with carbon capture and sequestration
<b>ALCF</b>	Argonne Leadership Computing Facility	<b>BIPV</b>	building integrated photovoltaics
<b>ALD</b>	atomic layer deposition	<b>BLIP</b>	Brookhaven Linac Isotope Producer
<b>ALS</b>	Advanced Light Source	<b>BNL</b>	Brookhaven National Laboratory
<b>AMI</b>	advanced metering technology	<b>BOEM</b>	Bureau of Ocean Energy Management
<b>AMP</b>	Advanced Manufacturing Partnership	<b>BOP</b>	blowout preventer
<b>ANL</b>	Argonne National Laboratory	<b>BP</b>	British Petroleum
<b>API</b>	American Petroleum Institute	<b>BRCs</b>	Bioenergy Research Centers
<b>APS</b>	Advanced Photon Source	<b>BTO</b>	U.S. Department of Energy Building Technologies Office
<b>APU</b>	auxiliary power unit	<b>BTRIC</b>	Buildings Technology Research and Integration Center
<b>ARM</b>	Atmospheric Radiation Measurement Climate Research Facility	<b>BTS</b>	Billion-Ton Study
<b>ARPA-E</b>	Advanced Research Projects Agency-Energy	<b>Btu</b>	British thermal unit
<b>ARRA</b>	American Reinvestment and Recovery Act		
<b>ASCAC</b>	Advanced Scientific Computing Advisory Committee		



<b>CAES</b>	compressed air energy storage	<b>CO<sub>2</sub>-eq</b>	CO <sub>2</sub> -equivalent global warming potential
<b>CAFÉ</b>	corporate average fuel economy	<b>COE</b>	cost of energy
<b>CAIDI</b>	customer average interruption duration index	<b>COP</b>	crude oil price
<b>CASL</b>	Consortium for the Advanced Simulation of Light Water Reactors	<b>COPV</b>	composite overwrapped pressure vessel
<b>CAVs</b>	connected and automated vehicles	<b>CORAL</b>	Collaboration of Oak Ridge, Argonne, and Livermore
<b>CBO</b>	Congressional Budget Office	<b>CRADA</b>	Collaborative Research and Development Agreement
<b>CBTL</b>	coal and biomass to liquids	<b>CRF</b>	Combustion Research Facility
<b>CBTLE</b>	coal and biomass to liquids and electricity	<b>CSD</b>	compression, storage and dispensing
<b>CBTLE-CCS</b>	coal and biomass to liquids and electricity with carbon capture and sequestration	<b>CSP</b>	concentrating solar thermal power
<b>CC</b>	combined cycle	<b>CSPAD</b>	Cornell-SLAC hybrid Pixel Array Detector
<b>CCE</b>	cost of conserved energy	<b>CT</b>	combustion turbine
<b>CCGT</b>	combined cycle gas turbine	<b>CTL</b>	coal to liquids
<b>CCN</b>	cloud condensation nuclei	<b>CVD</b>	chemical vapor deposition
<b>CCS</b>	carbon capture and storage	<b>CVR</b>	conservation voltage reduction
<b>CCWG</b>	Climate Change Working Group	<b>CXI</b>	Coherent X-ray Imaging
<b>CDF</b>	core damage frequency	<b>D&amp;D</b>	demonstration and deployment
<b>CEBAF</b>	Continuous Electron Beam Accelerator Facility	<b>DARPA</b>	Defense Advanced Research Agency
<b>CERN</b>	European Organization for Nuclear Research	<b>DC</b>	direct current
<b>CESAR</b>	Center for Exascale Simulation of Advanced Reactors	<b>DCV</b>	demand-controlled ventilation
<b>CFD</b>	computational fluid dynamics	<b>DEC</b>	direct energy conversion
<b>CFL</b>	compact florescent light	<b>DG</b>	distributed generation
<b>CFN</b>	Center for Functional Nanomaterials	<b>DHS</b>	U.S. Department of Homeland Security
<b>CFRP</b>	carbon fiber reinforced polymer	<b>DIII-D</b>	DIII-D Tokamak
<b>CH<sub>2</sub></b>	compressed hydrogen storage	<b>DLP</b>	digital light processing
<b>CH<sub>4</sub></b>	methane	<b>DMDII</b>	Digital Manufacturing and Design Innovation Institute
<b>CHHP</b>	combined heat, hydrogen and power	<b>DME</b>	dimethyl ether
<b>CHP</b>	combined heat and power	<b>DMLS</b>	direct metal laser sintering
<b>CI</b>	compression ignition	<b>DMS</b>	distribution management systems
<b>CIGS</b>	Copper-Indium-Gallium-Selenide	<b>DMT</b>	dry metric ton/tonne
<b>CINT</b>	Center for Integrated Nanotechnologies	<b>DMZs</b>	demilitarized zones
<b>CLIC</b>	Compact Linear Collider	<b>DNA</b>	deoxyribonucleic acid
<b>CMI</b>	Critical Materials Institute	<b>DOE</b>	U.S. Department of Energy
<b>CNM</b>	Center for Nanophase Materials Sciences	<b>DOE-EERE</b>	U.S. Department of Energy's Office of Energy Efficiency and Renewable Energy
<b>CO</b>	carbon monoxide	<b>DOE-FE</b>	U.S. Department of Energy's Office of Fossil Energy
<b>CO<sub>2</sub></b>	carbon dioxide	<b>DOE-IE</b>	U.S. Department of Energy's Office of Indian Energy Policy and Programs
<b>CO<sub>2</sub>-EOR</b>	CO <sub>2</sub> Enhanced Oil Recovery		

<b>DOE-NE</b>	U.S. Department of Energy's Office of Nuclear Energy	<b>FACET</b>	Facility for Advanced Accelerator Experimental Tests
<b>DOE-OE</b>	U.S. Department of Energy's Office of Electricity Delivery and Energy Reliability	<b>FACTS</b>	flexible alternating current transmission systems
<b>DOE-SC</b>	U.S. Department of Energy's Office of Science	<b>FASTMath</b>	Frameworks, Algorithms, and Scalable Technologies for Mathematics
<b>DR</b>	demand response	<b>FC</b>	fuel cell
<b>DSM</b>	demand-side management	<b>FCEV</b>	fuel cell electric vehicle
<b>E10</b>	a blend of 10% ethanol and 90% gasoline by volume	<b>FCL</b>	fault current limiter
<b>E85</b>	a blend of 85% ethanol and 15% gasoline by volume	<b>FCV</b>	fuel cell vehicle
<b>EBM</b>	electron beam melting	<b>FDM</b>	fused deposition modeling
<b>EDT</b>	electric drive technologies	<b>FERC</b>	Federal Energy Regulatory Commission
<b>EERE</b>	U.S. Department of Energy's Office of Energy Efficiency and Renewable Energy	<b>FLISR</b>	fault location isolation and service restoration
<b>EFRC</b>	Energy Frontier Research Centers	<b>flops</b>	floating point operations per second
<b>EGS</b>	enhanced geothermal systems	<b>FNAL</b>	Fermi National Accelerator Laboratory
<b>EI</b>	energy intensity	<b>FORGE</b>	Frontier Observatory for Research in Geothermal Energy
<b>EIA</b>	U.S. Energy Information Agency	<b>FRP</b>	fiber-reinforced polymer
<b>ELM</b>	edge-localized mode	<b>F-T</b>	Fischer-Tropsch
<b>EMF</b>	electromagnetic fields	<b>FY</b>	fiscal year
<b>EMIS</b>	electromagnetic isotope separator	<b>g/kWh</b>	grams per kilowatt-hour
<b>EMP</b>	electromagnetic pulse	<b>gal/MWh</b>	gallons per megawatt-hour
<b>EMS</b>	energy management system	<b>GaN</b>	gallium nitride
<b>EMSL</b>	Environmental Molecular Sciences Laboratory	<b>Gbps</b>	gigabits per second
<b>EOR</b>	enhanced oil recovery	<b>GCAM</b>	Global Change Assessment Model
<b>EPA</b>	U.S. Environmental Protection Agency	<b>GDP</b>	gross domestic product
<b>EPRI</b>	Electric Power Research Institute	<b>GE</b>	General Electric
<b>ERCOT</b>	Electric Reliability Council of Texas	<b>GeV</b>	gigaelectron volt
<b>EROI</b>	energy return on investment	<b>GFR</b>	gas-cooled fast reactor
<b>ESBWR</b>	Economic Simplified Boiling Water Reactor	<b>gge</b>	gallon of gasoline equivalent
<b>ESIF</b>	Energy Systems Integration Facility	<b>GHG</b>	greenhouse gas
<b>ESM</b>	Earth System Model	<b>GLBRC</b>	Great Lakes Bioenergy Research Center
<b>ESNet</b>	Energy Sciences Network	<b>GMD</b>	geomagnetic disturbance
<b>EUE</b>	expected unserved energy	<b>GPS</b>	global positioning system
<b>eV</b>	electron volt	<b>GSA</b>	U.S. General Services Administration
<b>EV</b>	electric vehicle	<b>GT</b>	gas turbine
<b>EVSE</b>	electric vehicle supply equipment	<b>Gt</b>	gigaton
<b>EWR</b>	enhanced water recovery	<b>GtC</b>	gigaton of carbon
<b>ExaCT</b>	Center for Exascale Simulation of Combustion in Turbulence	<b>GtCO<sub>2</sub></b>	gigaton of carbon dioxide
<b>ExMatEx</b>	Co-design Center for Materials in Extreme Environments	<b>GW</b>	gigawatt
		<b>GWh</b>	gigawatt-hour



<b>GWP</b>	global warming potential	<b>ISO</b>	independent system operator
<b>HC</b>	hydrocarbon	<b>ISO</b>	International Organization for Standardization
<b>HCCI</b>	homogeneous charge compression ignition	<b>IT</b>	information technology
<b>HDV</b>	heavy-duty vehicles	<b>ITER</b>	International Thermonuclear Experimental Reactor
<b>He-3</b>	helium-3	<b>JBEI</b>	Joint Bioenergy Institute
<b>HES</b>	hydrogen energy storage	<b>JCAP</b>	Joint Center for Artificial Photosynthesis
<b>HEV</b>	hybrid electric vehicles	<b>JCESR</b>	Joint Center for Energy Storage Research
<b>HFC</b>	hydrofluorocarbon	<b>JGI</b>	Joint Genome Institute
<b>HFIR</b>	High Flux Isotope Reactor	<b>kBtu</b>	thousand British thermal units
<b>HHV</b>	higher heating value	<b>kBtu/hr</b>	thousand British thermal units per hour
<b>HILF</b>	high-impact, low-frequency	<b>kBtu/sq. ft.</b>	thousand British thermal units per square foot
<b>HPC</b>	high-performance computing	<b>kg</b>	kilogram
<b>HPCEE</b>	High Performance Computer for Energy and the Environment	<b>klm</b>	kilolumen
<b>HPCIC</b>	HPC Innovation Center	<b>kms</b>	kilometers
<b>HT</b>	high temperature	<b>KMWh</b>	thousand megawatt hours
<b>HTS</b>	high-temperature superconductors	<b>kV</b>	kilovolt
<b>HVAC</b>	heating, ventilation, and air conditioning	<b>kW</b>	kilowatt
<b>HVAC</b>	high voltage alternating current	<b>kWh</b>	kilowatt-hour
<b>HVDC</b>	high-voltage direct current	<b>LANL</b>	Los Alamos National Laboratories
<b>IACMI</b>	Institute for Advanced Composites Manufacturing Innovation	<b>LAP</b>	laser-plasma accelerator
<b>IAM</b>	integrated assessment model	<b>LBNL</b>	Lawrence Berkeley National Laboratory
<b>ICE</b>	internal combustion engine	<b>LCA</b>	life-cycle assessment
<b>ICEV</b>	internal combustion engine vehicle	<b>LCI</b>	life-cycle inventory
<b>ICT</b>	information and communications technologies	<b>LCIA</b>	life-cycle impact assessment
<b>IDPRA</b>	Isotope Development and Production for Research and Applications subprogram	<b>LCLS</b>	Linac Coherent Light Source
<b>IEA</b>	International Energy Agency	<b>LCLS-II</b>	Linac Coherent Light Source-II
<b>IEEE</b>	Institute of Electrical and Electronics Engineers	<b>LCOD</b>	levelized cost of driving
<b>IGCC</b>	integrated gasification combined cycle	<b>LCOE</b>	levelized cost of electricity
<b>IGSM</b>	Integrated Global Systems Model	<b>LDV</b>	light-duty vehicles
<b>ILC</b>	International Linear Collider	<b>LED</b>	light-emitting diode
<b>ILL</b>	Institut Laue-Langevin	<b>LFR</b>	lead-cooled fast reactor
<b>INCITE</b>	Innovative and Novel Computational Impact on Theory and Experiment	<b>LHC</b>	Large Hadron Collider
<b>INL</b>	Idaho National Laboratory	<b>LHV</b>	lower heating value
<b>IOR</b>	improved oil recovery	<b>Li/LMRNMC</b>	lithium metal batteries with lithium- and manganese-rich high-energy cathode
<b>IPCC</b>	Intergovernmental Panel on Climate Change	<b>LIFT</b>	Lightweight Innovations for Tomorrow Consortium
<b>IPF</b>	Isotope Production Facility	<b>Li-ion</b>	lithium-ion
		<b>LLNL</b>	Lawrence Livermore National Laboratory
		<b>lm/W</b>	lumens per watt



<b>LMD</b>	laser metal deposition	<b>NEA</b>	Nuclear Energy Agency of the OECD
<b>LMRNMC</b>	lithium- and manganese-rich high-energy cathode	<b>NERC</b>	North American Electric Reliability Corporation
<b>LNG</b>	liquefied natural gas	<b>NERSC</b>	National Energy Research Scientific Computing Center
<b>LOLP</b>	loss of load probability	<b>NETL</b>	National Energy Technology Laboratory
<b>LOM</b>	laminated object manufacturing	<b>NiMH</b>	nickel-metal hydride
<b>LPA</b>	laser-plasma accelerator	<b>NIR</b>	near-infrared
<b>LPG</b>	liquefied petroleum gas	<b>NIST</b>	National Institute of Standards and Technology
<b>LPTs</b>	large power transformers	<b>NNI</b>	National Nanotechnology Initiative
<b>LTC</b>	low-temperature combustion	<b>NNSA</b>	U.S. National Nuclear Security Administration
<b>LUEI</b>	land use energy intensity	<b>NOx</b>	nitrogen oxides
<b>LWR</b>	light water reactors	<b>NPC</b>	National Petroleum Council
<b>M&amp;V</b>	measurement and verification	<b>NRC</b>	U.S. Nuclear Regulatory Commission
<b>MCFC</b>	molten carbonate fuel cell	<b>NREL</b>	National Renewable Energy Laboratory
<b>MDF</b>	Materials Demonstration Facility	<b>NSF</b>	National Science Foundation
<b>MDF</b>	Manufacturing Demonstration Facility	<b>NSLS-II</b>	National Synchrotron Light Source-II
<b>MDV</b>	medium-duty vehicles	<b>NSRCs</b>	Nanoscale Science Research Centers
<b>MEA</b>	membrane electrode loading	<b>NSTX-U</b>	National Spherical Torus Experiment
<b>MEL</b>	miscellaneous electric loads	<b>NSUF</b>	Nuclear Scientific User Facilities
<b>MESP</b>	minimum ethanol selling price	<b>NTRC</b>	National Transportation Research Center
<b>Mg</b>	magnesium	<b>O&amp;M</b>	operations and maintenance
<b>MGI</b>	Materials Genome Initiative for Global Competitiveness	<b>OE</b>	U.S. Department of Energy, Office of Electricity Delivery and Energy Reliability
<b>MHK</b>	marine and hydrokinetic	<b>OECD</b>	Organisation for Economic Cooperation and Development
<b>MIT</b>	Massachusetts Institute of Technology	<b>OG&amp;E</b>	Oklahoma Gas & Electric
<b>MITEI</b>	Massachusetts Institute of Technology Energy Initiative	<b>OLCF</b>	Oak Ridge Leadership Computing Facility
<b>MJM</b>	multi-jet modeling	<b>OLED</b>	organic light-emitting diode
<b>MMT</b>	million metric ton/tonne	<b>ORNL</b>	Oak Ridge National Laboratory
<b>MOF</b>	metal organic framework	<b>OT</b>	operational technology
<b>MON</b>	motor octane number	<b>PAFC</b>	phosphoric acid fuel cell
<b>MOSFET</b>	metal-oxide-semiconductor field-effect transistor	<b>PBIH</b>	powder bed and inkjet head
<b>MOSIS</b>	Silicon Metal Oxide Semiconductor Implementation System	<b>PC</b>	pulverized coal
<b>MRI</b>	magnetic resonance imaging	<b>PCCI</b>	pre-mixed charge compression ignition
<b>MT</b>	metric ton/tonne	<b>PCT</b>	programmable communicating thermostat
<b>MV</b>	medium voltage		
<b>MW</b>	megawatt		
<b>MWe</b>	megawatt electric		
<b>MWh</b>	megawatt-hour		
<b>NAS</b>	National Academy of Sciences		
<b>NaS</b>	sodium sulfur		
<b>NASA</b>	National Aeronautics and Space Administration		
<b>NCNR</b>	NIST Center for Neutron Research		



<b>PEC</b>	photoelectrochemical	<b>RDD&amp;D</b>	research, development, demonstration, and deployment
<b>PEMFC</b>	polymer electrolyte membrane fuel cell	<b>REACT</b>	Rare Earth Alternatives in Critical Technologies for Energy
<b>PEV</b>	plug-in electric vehicle	<b>RESU</b>	residential energy storage unit
<b>pflops</b>	petaflops	<b>RF</b>	radiofrequency
<b>PFSA</b>	perfluorosulfonic acid	<b>RHIC</b>	Relativistic Heavy Ion Collider
<b>PFTE</b>	polytetrafluoroethylene	<b>RIAM</b>	regional integrated assessment model
<b>PGM</b>	platinum group metals	<b>RICE</b>	reciprocating internal combustion engine
<b>PHEV</b>	plug-in hybrid electric vehicle	<b>RNA</b>	ribonucleic acid
<b>PHS</b>	pumped hydro storage	<b>ROI</b>	return on investment
<b>PI</b>	process intensification	<b>RON</b>	research octane number
<b>PJM</b>	Pennsylvania, New Jersey and Maryland Regional Transmission Operator	<b>ROZ</b>	residual oil zones
<b>PM</b>	particulate matter	<b>Ru</b>	ruthenium
<b>PM<sub>10</sub></b>	particulate matter less than 10 micrometers in diameter	<b>SAIDI</b>	system average interruption duration index
<b>PM<sub>2.5</sub></b>	particulate matter less than 2.5 micrometers in diameter	<b>SAIFI</b>	system average interruption frequency index
<b>PMU</b>	phasor measurement units	<b>SANS</b>	small angle neutron scattering
<b>PNNL</b>	Pacific Northwest National Laboratory	<b>SC</b>	U.S. DOE Office of Science
<b>Poly/Comp</b>	polymer composites	<b>SCADA</b>	supervisory control and data acquisition
<b>POTW</b>	publicly owned treatment work	<b>SC-ASCR</b>	U.S. DOE Office of Advanced Scientific Computing
<b>PP</b>	plaster-based 3D printing	<b>SC-BER</b>	U.S. DOE Biological and Environmental Research Program
<b>PPPL</b>	Princeton Plasma Physics Laboratory	<b>SC-BES</b>	U.S. DOE Office of Basic Energy Science
<b>PQ</b>	power quality	<b>SCC</b>	social cost of carbon
<b>PUE</b>	power use effectiveness	<b>SC-FES</b>	U.S. DOE Office of Fusion Energy Science
<b>PV</b>	photovoltaic	<b>SC-HEP</b>	U.S. DOE Office of High Energy Physics
<b>PWR</b>	pressurized water reactor	<b>SciDAC</b>	Scientific Discovery through Advanced Computing
<b>QCD</b>	quantum chromodynamics	<b>SC-NP</b>	U.S. DOE Office of Nuclear Physics
<b>QER</b>	Quadrennial Energy Review	<b>sCO<sub>2</sub></b>	supercritical carbon dioxide
<b>QOOH</b>	hydroperoxyalkyl	<b>SDAV</b>	scalable data management, analysis and visualization
<b>QTR</b>	Quadrennial Technology Review	<b>SEP</b>	Superior Energy Performance Program
<b>quad</b>	quadrillion British thermal units	<b>SFR</b>	sodium-cooled fast reactor
<b>QUEST</b>	Quantification of Uncertainty in Extreme Scale Computations	<b>SGIG</b>	Smart Grid Investment Grant Program
<b>R&amp;D</b>	research and development	<b>SHS</b>	selective heat sintering
<b>R2R</b>	roll-to-roll	<b>Si</b>	silicon
<b>RAP</b>	resilience analysis process	<b>SI</b>	spark ignition
<b>RC</b>	Rankine cycle engine		
<b>RCCI</b>	reactivity controlled compression ignition		
<b>RCSP</b>	Regional Carbon Sequestration Partnerships		
<b>RD&amp;D</b>	research, development, and demonstration		

<b>Si/LMRNMC</b>	lithium- and manganese-rich high-energy cathode with silicon alloy anodes	<b>TWh/year</b>	terawatt-hours per year
<b>SiC</b>	silicon carbide	<b>UC</b>	unit of capacity
<b>SIEGate</b>	Secure Information Exchange Gateway	<b>UCC</b>	ultra-conductive copper
<b>SLA</b>	stereolithography	<b>UCPTE</b>	Union for the Coordination of Production and Transmission of Electricity
<b>SLAC</b>	SLAC National Accelerator Laboratory	<b>UE</b>	unit of energy
<b>SLS</b>	selective laser sintering	<b>UNF</b>	used nuclear fuel
<b>SMES</b>	superconducting magnetic energy storage	<b>UNFCCC</b>	United Nations Framework Convention on Climate Change
<b>SMR</b>	small modular reactors	<b>UOG</b>	unconventional oil and gas
<b>SMR</b>	steam methane reforming	<b>URCI</b>	universal remote circuit interrupter
<b>SNCR</b>	selective non-catalytic reduction	<b>USB</b>	universal serial bus
<b>SNL</b>	Sandia National Laboratory	<b>USDA</b>	U.S. Department of Agriculture
<b>SNS</b>	Spallation Neutron Source	<b>USGS</b>	U.S. Geological Survey
<b>SO<sub>2</sub></b>	sulfur dioxide	<b>UV</b>	ultraviolet
<b>SOC</b>	state-of-charge	<b>V&amp;V</b>	verification and validation
<b>SOFC</b>	solid oxide fuel cell	<b>V2B</b>	vehicle-to-building
<b>SO<sub>x</sub></b>	sulfur oxides	<b>V2G</b>	vehicle-to-grid
<b>SPP</b>	Strategic Partnership Projects	<b>V2I</b>	vehicle-to-infrastructure
<b>SRF</b>	superconducting radio frequency	<b>V2V</b>	vehicle-to-vehicle
<b>SSDT</b>	solid state distribution transformer	<b>VAR</b>	volt-ampere reactive
<b>SSRLS</b>	Stanford Synchrotron Radiation Light Source	<b>VERA</b>	Virtual Environment for Reactor Application
<b>SST</b>	solid-state transformer	<b>VFD</b>	variable frequency drive
<b>ST</b>	steam turbine	<b>VOC</b>	volatile organic carbon
<b>STP</b>	set top boxes (for TVs)	<b>VOCs</b>	volatile organic compounds
<b>SubTER</b>	Subsurface Technology and Engineering Research	<b>VVO</b>	volt/volt ampere reactive optimization
<b>SUPER</b>	Institute for Sustained Performance, Energy, and Resilience	<b>W/kg</b>	watts per kg
<b>T&amp;D</b>	transmission and distribution	<b>WACC</b>	weighted average capital cost
<b>TB</b>	terabyte	<b>WAG</b>	water-alternating-gas
<b>TBtus</b>	trillion British thermal units	<b>WBG</b>	wide bandgap
<b>TCEP</b>	Texas Clean Energy Project	<b>Wh/kg</b>	watt-hours per kg
<b>Tcf</b>	trillion cubic feet	<b>Wh/l</b>	watt-hours per liter
<b>TEDF</b>	Technology and Engineering Development Facility	<b>WHP</b>	waste heat to power
<b>TEG</b>	thermoelectric generators	<b>WHR</b>	waste heat recovery
<b>TI</b>	technology innovation	<b>WNUF</b>	Wireless National User Facility
<b>TJNAF</b>	Thomas Jefferson National Accelerator Facility	<b>ZNE</b>	residential zero-net-energy customer
<b>TMF</b>	The Molecular Foundry		
<b>TR</b>	technology roadmapping		
<b>TRLs</b>	Technology Readiness Levels		
<b>TWh</b>	terawatt-hour		



# List of Figures

Figure Number and Title	Page
<b>Executive Summary</b>	
<b>Figure ES.1</b> Sankey Diagram of the U.S. Energy System Depicting Major Areas of Coverage by the Technical QTR Chapters 3–8	4
<b>Chapter 1</b>	
<b>Figure 1.1</b> The Sankey Diagram depicts the flow of energy resources (left) to end-use sectors (right)	12
<b>Figure 1.2a</b> U.S. Primary Energy (a) Supply and (b) Consumption in the End Use Sectors	13
<b>Figure 1.2b</b> U.S. Electric Power by (a) Total Primary Input and Electricity Generation by Source; and (b) Electricity End Use by Sector	13
<b>Figure 1.3a</b> Building Sector Energy by (a) Primary Energy Supply and (b) Energy End Uses as a percent of total U.S. building energy supply and use	14
<b>Figure 1.3b</b> Industry Sector Energy by (a) Primary Energy Supply and (b) Energy End Uses and as a percent of total U.S. industry energy supply and use	14
<b>Figure 1.3c</b> Transportation Sector Energy by (a) Primary Energy Supply and (b) Energy End Uses and as a percent of total U.S. transportation energy supply and use	14
<b>Figure 1.4</b> U.S. Primary Energy Use over Time in Quads	15
<b>Figure 1.5</b> EIA Projections for Growth of Energy Demand (in quads) in OECD and Non-OECD Markets to 2040	18
<b>Figure 1.6</b> Energy Prices by Year for the Coal, Natural Gas, and Oil Markets	20
<b>Figure 1.7</b> U.S. CO <sub>2</sub> Emissions by (a) Primary Energy Source as a percent of total U.S. energy-related CO <sub>2</sub> Emissions (in million metric tonnes); and (b) End Use Sector	22
<b>Figure 1.8</b> Percentage of Gross Sales Invested in R&D for Selected Sectors of the U.S. Economy and U.S. Clean Energy Venture Capital Investment	24
<b>Figure 1.9</b> Learning Curves for Selected Technologies	25
<b>Chapter 2</b>	
<b>Figure 2.1</b> Multiple Scales of the Integrated Electrical System	39
<b>Figure 2.2</b> Potentially Net-Negative Carbon Flows in a Hybrid Polygeneration CBTLE-CCS System	42
<b>Chapter 3</b>	
<b>Figure 3.1</b> Estimated U.S. Energy Use in 2014	54



<b>Figure 3.2</b> Traditional Electricity Delivery System	55
<b>Figure 3.3</b> Evolution of the Electric Power Grid	56
<b>Figure 3.4</b> Spending on Smart Grid Technologies 2008–2013, with Projections to 2017	58
<b>Figure 3.5</b> Comparison between Voltage Signals from the Event as Captured by SCADA versus PMU Data for Western Electricity Coordinating Council Wind Farm Oscillations	58
<b>Figure 3.6</b> Weather-Related Grid Disruptions, 2000–2012	59
<b>Figure 3.7</b> Example of Analysis using Synchrophasor Data: August 14, 2003 Blackout	61
<b>Figure 3.8</b> Illustrative Sequence of Cascading Events in the 2011 Southwest Blackout	62
<b>Figure 3.9</b> California ISO Projected Electricity Supply	63
<b>Figure 3.10</b> Comparison of Key Attributes of Current and Future Systems	64
<b>Figure 3.11</b> Grid Architecture Structure Types	65
<b>Figure 3.12</b> Fundamental Changes in Power System Characteristics	66
<b>Figure 3.13</b> Data Flows from Transmission Owners to Regional Hubs, Between Reliability Coordinators, and Between Transmission Operators	70
<b>Figure 3.14</b> Pathway to Speed Improvements in Analytical Decision Making	71
<b>Figure 3.15</b> Times Associated with Clearing a Fault	72
<b>Figure 3.16</b> Stages of Adoption of Transactive Operations for Industry	74
<b>Figure 3.17</b> Excessive Transformer Heating from Reversed Power Flows	75
<b>Figure 3.18</b> Conceptual Diagram for Solid-State Distribution Transformer Function	76
<b>Figure 3.19</b> Different Microgrid Configurations	81
<b>Figure 3.20</b> Applications of Electric Energy Storage Technologies	82
<b>Figure 3.21</b> Scales of Power Systems Operations and Planning	85
<b>Figure 3.22</b> 2014 Reported Power Outages by Eight Possible Causes	87
<b>Figure 3.23</b> Cross-Organizational Chain of Trust	90
<b>Chapter 4</b>	
<b>Figure 4.1</b> Requirements and criteria have expanded over time.	103
<b>Figure 4.2</b> SaskPower Boundary Dam CCS Project: Pushing CCS Forward Internationally	104
<b>Figure 4.3</b> Southern Company Kemper Project	105
<b>Figure 4.4</b> Potential for Bringing Down Nth-of-a-Kind Cost Compared to First-Generation CCS Technology	106
<b>Figure 4.5</b> Cost Projections for Advanced Fossil-CCS Plants	108
<b>Figure 4.6</b> Regional Carbon Sequestration Partnerships	109
<b>Figure 4.7</b> U.S. Nuclear Capacity and Generation Since 1980	112
<b>Figure 4.8</b> Core Damage Frequency (CDF) Estimates of U.S. Reactor Types	113
<b>Figure 4.9</b> Land-Based Wind Changes in LCOE by Sensitivity	120

<b>Figure 4.10</b> Offshore Wind Changes in LCOE by Sensitivity	121
<b>Figure 4.11</b> Scale of Biopower Plants in the United States	122
<b>Figure 4.12</b> Biomass Gasification with CO <sub>2</sub> Capture and Combined-Cycle Power Generation	124
<b>Figure 4.13</b> Utility PV Cost Reductions Since 2010 and Required Reductions for Cost Competitiveness	125
<b>Chapter 5</b>	
<b>Figure 5.1</b> Buildings Use More Than 38% of all U.S. Energy and 76% of U.S. Electricity	145
<b>Figure 5.2</b> Use of ENERGY STAR® technologies would reduce residential energy consumption 30%, best available technology 50%, goals of ET 52% and theoretical limits 62%.	146
<b>Figure 5.3</b> Use of ENERGY STAR® technologies would reduce commercial energy consumption 21%, best available technology 46%, goals of ET 47% and theoretical limits 59%.	146
<b>Figure 5.4</b> Only 44% of the energy in sunlight is visible light.	149
<b>Figure 5.5</b> Types of Building Heating Equipment	152
<b>Figure 5.6</b> Use of the most efficient wall, window, and HVAC equipment now available could reduce residential cooling 61%.	155
<b>Figure 5.7</b> Use of the most efficient wall, window, and HVAC equipment now available could eliminate residential heating.	155
<b>Figure 5.8</b> Use of the most efficient wall, window, and HVAC equipment now available could reduce commercial cooling 78%.	156
<b>Figure 5.9</b> Use of the most efficient wall, window, and HVAC equipment now available could reduce commercial heating 77%.	156
<b>Figure 5.10</b> Most light fixtures are in residences, but the bulk of lighting energy is in commercial buildings.	158
<b>Figure 5.11</b> The efficiency of the human eye is highest for green light at 683 lumens per watt.	159
<b>Figure 5.12</b> Energy Savings from Lighting Retrofits	161
<b>Figure 5.13</b> The price and performance of LEDs have steadily improved since 2009.	162
<b>Figure 5.14</b> A combination of improved lighting devices and controls meeting 2020 program goals (ET) can reduce residential lighting energy 93% of the theoretical limit.	163
<b>Figure 5.15</b> A combination of improved lighting devices and controls meeting 2020 program goals (ET) can reduce commercial lighting energy 81% of the theoretical limit.	163
<b>Figure 5.16</b> The “other” category of demand in buildings is created by a huge variety of devices—many of which are miscellaneous electric loads.	167
<b>Figure 5.17</b> Future grid systems and smart building controls can communicate in ways that improve overall system efficiency and reliability.	169
<b>Figure 5.18</b> More than seven quads of energy could be saved in buildings by cost effective technologies by 2030.	173
<b>Chapter 6</b>	
<b>Figure 6.1</b> Manufacturing Share of the Nation's Overall Energy Consumption and Breakdown of Manufacturing Primary Energy Consumption by Subsector (2010)	183
<b>Figure 6.2</b> Levels of System Integration in Manufacturing	184



<b>Figure 6.3</b> Constellation Diagram Showing Connections Between the Fourteen Manufacturing Technologies Analyzed in Technology Assessments	185
<b>Figure 6.4</b> Sankey Diagram of Primary Energy Flow in the U.S. Manufacturing Sector (2010)	187
<b>Figure 6.5</b> Sankey Diagram of U.S. Manufacturing Sector Process Energy Flow in 2010	187
<b>Figure 6.6</b> Projected Annual Energy Savings (TBtu/year) for Fleet-wide Adoption of Additive Manufactured Components in Aircraft, Assuming Slow, Midrange and Rapid Adoption Scenarios	194
<b>Figure 6.7</b> Delphi Diesel Engine Pump Housing Fabricated via Selective Laser Melting	195
<b>Figure 6.8</b> Bandwidth Diagrams Illustrating Energy Savings Opportunities in Four Energy-Intensive U.S. Manufacturing Industries	196
<b>Figure 6.9</b> CHP systems produce thermal energy and electricity concurrently from the same energy input, and can therefore achieve higher system efficiencies than separate heat and power systems.	197
<b>Figure 6.10</b> Theoretical Efficiencies (electric generation only) for Various CHP Configurations, Ranging from Single-Cycle Systems to Double- and Triple-Cycle Systems that Make Use of Multiple Generation Technologies	198
<b>Figure 6.11</b> Medium-term (from 2015 to 2025) Criticality Matrix for Elements Important to Wind Turbines, Electric Vehicles, Photovoltaic Cells, and Fluorescent Lighting	206
<b>Figure 6.12</b> Energy Savings Opportunities for One Pound of Carbon Fiber Reinforced Polymer Composite, Broken Down by Subprocess	214
<b>Figure 6.13</b> Potential Cost Reduction Strategies for Composite Overwrapped Pressure Vessels to Meet the 2020 U.S. DRIVE Cost Target	214
<b>Chapter 7</b>	
<b>Figure 7.1</b> Sankey Diagram of Transportation Fuel Use	227
<b>Figure 7.2</b> Shale Resources Remain the Dominant Source of U.S. Natural Gas Production Growth	230
<b>Figure 7.3</b> Expected Gains in Tight Oil Production Drive Projected Growth in Total U.S. Crude Oil Production	230
<b>Figure 7.4</b> BP Deepwater Horizon Oil Spill April 20, 2010	231
<b>Figure 7.5</b> Gas Hydrate Resource Pyramid	234
<b>Figure 7.6</b> Emerging Issues of UOG Development	235
<b>Figure 7.7</b> Overall Pathway for Production of Fuels from Biomass	241
<b>Figure 7.8</b> R&D options are available to address most products from the whole barrel of oil.	242
<b>Figure 7.9</b> Life-Cycle Greenhouse Gas Emissions of Selected Pathways	243
<b>Figure 7.10</b> Total Estimated Sustainable Bioenergy Resource Potential Supply Curve at Marginal Prices Between \$20 and \$200 per Dry Metric Ton in 2022	243
<b>Figure 7.11</b> Growth in U.S. Ethanol Production Capacity	245
<b>Figure 7.12</b> Historical and Projected Volumes of Biomass Available at a Delivered Cost of \$80/ Dry Metric Ton for Various Biomass Types, Accommodating Multiple Conversion Processes	246
<b>Figure 7.13</b> Historical and Projected Delivered Woody Feedstock Costs, Modeled for Pyrolysis Conversion	247



<b>Figure 7.14</b> Correlation Between Lignin and Energy Content in Biomass Samples	248
<b>Figure 7.15</b> Conversion Pathways from Feedstock to Products	250
<b>Figure 7.16</b> Cost Projection Breakdown for the Fast Pyrolysis Design Case, 2009–2017	251
<b>Figure 7.17</b> Producing oxygenated chemicals from olefins involves increasing the molecular weight via oxidation.	253
<b>Figure 7.18</b> Hydrogen Offers Important Long-Term Value as a Clean Energy Carrier	256
<b>Figure 7.19</b> Existing Centralized Hydrogen Production Facilities in the United States	257
<b>Figure 7.20</b> Many possible pathways for production and delivery of hydrogen exist.	258
<b>Figure 7.21</b> Hydrogen Production and Delivery RDD&D Priorities and Key Focus Areas	259
<b>Figure 7.22</b> Current Range of Hydrogen Production Costs	261
<b>Figure 7.23</b> RDD&D Timeline for Hydrogen Production and Delivery	263
<b>Chapter 8</b>	
<b>Figure 8.1</b> Composition of 2014 Energy Use in Transportation	277
<b>Figure 8.2</b> Well-to-Wheels Petroleum Use and GHG Emissions for 2035 Mid-Size Cars	279
<b>Figure 8.3</b> Potential Benefits of Advanced Transportation Technologies	280
<b>Figure 8.4</b> Overview of Key Transportation Technologies and Performance Targets Based on DOE Assessment of Current RDD&D Activities	282
<b>Figure 8.5</b> Catalyzed Particulate Filter Air Flow Modeling	284
<b>Figure 8.6</b> Complex In-cylinder Flow During Intake Stroke in Diesel Engine	285
<b>Figure 8.7</b> Vehicle-level Technology Contributions to Efficiency	288
<b>Figure 8.8</b> Trends of Lightweight Materials Use in Vehicles	290
<b>Figure 8.9</b> Weight Reduction Opportunities if the Indicated Material was Applied to the Greatest Extent Possible	292
<b>Figure 8.10</b> Battery Performance Advancements that are Needed to Enable a Large Market Penetration of PEVs	293
<b>Figure 8.11</b> Modeled Cost and Energy Density of PEV Batteries Developed and Tested	294
<b>Figure 8.12</b> Advanced Battery Technology Low-cost Pathway	295
<b>Figure 8.13</b> Schematic Diagram of a PEV	297
<b>Figure 8.14</b> Breakdown of the 2014 Projected Fuel Cell Stack Cost at 1,000 and 500,000 Systems Per Year	301
<b>Figure 8.15</b> Fuel Cell Performance Advancements Needed to Enable a Large Market Penetration of FCEVs	302
<b>Figure 8.16</b> Energy per Passenger-mile by Mode in 2002 and 2012 with Percent Change from 2002 to 2012 Shown Above the 2012 Bars	306
<b>Figure 8.17</b> Transportation as a System of Systems	311



## Chapter 9

- Figure 9.1** Locations of Current Energy Frontier Research Centers (EFRC) and Partnering Institutions 324
- Figure 9.2** The structure of four representative MOFs demonstrates the large diversity within this class of materials. 325
- Figure 9.3** (a) A solar fuel-generating device would mimic the natural photosynthesis carried out in a leaf, capturing solar energy and converting it into chemical energy stored as a liquid fuel. (b) The titanium dioxide ( $\text{TiO}_2$ ) protective layer stabilizes the silicon photoanode against corrosion so that hydroxide ions ( $\text{OH}^-$ ) in the electrolyte can be continuously oxidized to oxygen gas ( $\text{O}_2$ ). 327
- Figure 9.4** Optimization of microbial metabolism leads to enhanced production of advanced biofuels such as isopentenol. 328
- Figure 9.5** (a) Formation and destruction of the resonance stabilized QOOH ( $\text{c-C}_7\text{H}_9\text{O}_2$ ) radical intermediate. 333
- Figure 9.6** (a) The 132-meter LCLS Undulator Hall (b) Artists concept showing a CO molecule made of a carbon atom (black) and an oxygen atom (red), reacting with an oxygen atom. 335
- Figure 9.7** Neutron tomographic imaging techniques available at the DOE-SC neutron scattering scientific user facilities SNS (a) and HFIR (c) were used by Morris Technologies to evaluate internal stresses in turbine blades produced by additive manufacturing (b). 337
- Figure 9.8** Nanocrystals of indium tin oxide (blue) embedded in a glassy matrix of niobium oxide (green) form a composite material that can switch between visible or near-infrared light transmitting and blocking states by application of an electric potential. 339
- Figure 9.9** Control of the synthesis results in a diversity of self-assembled structures formed by sticky epoxy droplets: (a) array of “mushrooms,” (b) wavy colloidal “fur,” (c) dense fiber network, and (d) a 3D reconstruction of the dense fiber network. 341
- Figure 9.10** (a) Samples for metagenomic analyses collected from numerous sites across the globe and sequenced at the JGI have detected numerous previously unknown microbial species. (b) The results shine a metagenomic spotlight on previously unknown areas of the phylogenetic tree, thereby broadening our view of the diversity of the microbial world. 343
- Figure 9.11** (a) Under normal conditions, a cloud droplet (and cloud ice particle) requires a microscopic particle on which water vapor can condense. It was assumed that only a small fraction of airborne particles have the right chemistry and/or geometry to condense water vapor. (b) Using samples collected by the DOE ARM facility and chemical imaging and micro-spectroscopic techniques at the EMSL, it was discovered that nearly all classes of particles can serve as cloud condensation nuclei for droplet and ice but with variation in formation efficiency that depends on organic coatings. This new information will be used to improve model parameterizations and reduce uncertainties in climate predictions. 345
- Figure 9.12** Analysis of an eleven-year record of spectral radiance data from ARM sites in Oklahoma and Alaska confirmed theoretical predictions that higher concentrations of atmospheric  $\text{CO}_2$  result in increased absorption of infrared energy, and hence atmospheric warming. Until now, the measurement accuracy combined with the length of the data record was inadequate to “prove” beyond doubt that increasing  $\text{CO}_2$  must relate to global warming via infrared heating, thus making this analysis groundbreaking. (a) The ARM Oklahoma site. (b) One of the two AERIs that were used to collect the eleven-year data record at both sites. 347
- Figure 9.13** The semiconductor indium nitride, which typically emits infrared light, will emit green light if reduced to a one nanometer-wide wire. 350
- Figure 9.14** The features and implied energy prices of the stochastic programming formulation is shown for the state of Illinois. 352

<b>Figure 9.15</b> Dresser-Rand is simulating equipment that could enable CCS at a significantly lower cost than that offered by conventional equipment. Below is a visualization from a simulation of NASA Glenn Research Center’s transonic fan stage experiment prior to stall.	353
<b>Figure 9.16</b> The CSPAD camera at the LCLS produces 150 TB molecular “snapshots.”	355
<b>Figure 9.17</b> Using VERA, CASL investigators successfully performed full core physics power-up simulations (right) of the Westinghouse AP1000 PWR core.	356
<b>Figure 9.18</b> The BELLA laser (a) is a Ti:Sapphire chirped-pulse amplification laser capable of pulsed peta-watt level peak power at a frequency of a single hertz. The work was selected as one of ten Best Physics Papers of 2014 by Scientific American. Simulations (b) run at NERSC show a laser plasma wakefield as it evolves in a nine-centimeter long tube of plasma. The charge “wake” (three are shown) allows electrons to “ride” the wake to greater and greater energies.	360
<b>Figure 9.19</b> Optical fibers give off a green glow as they carry light pulses from the scintillator material to an external photomultiplier counting array in the wavelength-shifting optical fiber neutron detector.	362
<b>Figure 9.20</b> The EMIS for Stable Isotope Enrichment at ORNL	364
<b>Figure 9.21</b> (a) Inside the DIII-D Tokamak. (b) The position of approximately one hundred magnetic sensors (red dots) recently installed around the plasma. (c) Simulations of the cross-section of the DIII-D plasma show the response typical of non-suppression (c, left) and ELM suppression (c, right), in agreement with experimental measurements.	365
<b>Chapter 10</b>	
<b>Figure 10.1</b> Overall Flowchart of the RDD&D Decision-Making Process	380
<b>Figure 10.2</b> Illustrative Comparison of Life-Cycle GHG Emissions of Various Electricity Generation Technologies	385
<b>Figure 10.3</b> Life Cycle Water Consumption Estimates for Various Electricity Generation Technologies	387
<b>Figure 10.4</b> Critical Materials in the Medium Term (2015–2025)	390
<b>Figure 10.5</b> Example of Options Space Visualization for the Electricity Sector	392
<b>Figure 10.6</b> Stabilization Wedges Concept	393
<b>Figure 10.7</b> Efficiency Supply Curve for Baseline Assumptions in 2030 for Selected Building Technologies	400
<b>Figure 10.8</b> Examples of techniques for displaying multiple metrics simultaneously include (a) radar plot and (b) color-coded stop light matrix.	402



# List of Tables

Table Number and Title	Page
<b>Chapter 1</b>	
<b>Table 1.1</b> Changes in Energy Supply and End-Use Demand from 2010 through 2014	18
<b>Chapter 2</b>	
<b>Table 2.1</b> Crosscutting Technology Table	46
<b>Chapter 3</b>	
<b>Table 3.1</b> Moving from Traditional to Modern Electric Power Systems—RDD&D Needs	68
<b>Table 3.2</b> Key Monitoring and Control Attributes for the Evolving Power System	69
<b>Table 3.3</b> Estimated Number of Nodes/Control Points per Entity Type	73
<b>Table 3.4</b> Cost and Performance Targets for Electric Energy Storage Technologies	83
<b>Table 3.5</b> Cybersecurity R&D Parameters	89
<b>Table 3.6</b> Fundamental Changes in Power System Characteristics	93
<b>Table 3.7</b> Summary of RDD&D Opportunities	94
<b>Chapter 4</b>	
<b>Table 4.1</b> Electric Power Capacity and Production, 2010 and 2014	102
<b>Table 4.2</b> Nuclear Power Capacity and Production, 2010 and 2014	111
<b>Table 4.3</b> Technical Challenges for Fuel Cell Types	129
<b>Table 4.4</b> Cost Targets versus Current Status – Medium-Scale (0.2–5 MW) Fuel Cells	129
<b>Table 4.5</b> Opportunities in Clean Electric Power Technology Development	137
<b>Chapter 5</b>	
<b>Table 5.1</b> Sample ET Program 2020 Goals	147
<b>Table 5.2</b> Energy Flows in Building Shells	148
<b>Table 5.3</b> Non-Vapor Compression Heat Pump Technologies	153
<b>Table 5.4</b> LED Efficiencies	162
<b>Table 5.5</b> Computers and Electronic Devices	165
<b>Table 5.6</b> Efficiencies of Electrical Devices	166
<b>Table 5.7</b> Fundamental Research Challenges	174
<b>Table 5.8</b> Increasing Efficiency of Building Systems and Technologies	175



## Chapter 6

<b>Table 6.1</b> Characteristics of Common Industrial Processes that Require Process Heating	188
<b>Table 6.2</b> RDD&D Opportunities for Process Heating and Projected Energy Savings	189
<b>Table 6.3</b> Energy Use of Major Motor-Driven Systems in U.S. Manufacturing	190
<b>Table 6.4</b> 2010 Production, Calculated Onsite Energy Consumption, and Energy Savings Potential for Eleven Chemicals	192
<b>Table 6.5</b> Additive Manufacturing Process Technologies and Materials Compatibilities	194
<b>Table 6.6</b> Life-Cycle Energy Comparison for an Aluminum Diesel Engine Pump Housing Manufactured via Gravity Die Casting and Selective Laser Melting	195
<b>Table 6.7</b> Technical Potential and Energy and Cost Savings for High Power-to-Heat CHP Operation	198
<b>Table 6.8</b> Strategic R&D Opportunities and Performance Targets for CHP	199
<b>Table 6.9</b> Examples of Manufacturing Technologies with Strong Potential for Life-Cycle Impacts	205
<b>Table 6.10</b> Key Elements for Energy-Related Technologies	207
<b>Table 6.11</b> Current Energy Demands for Primary and Secondary Aluminum Ingot	208
<b>Table 6.12</b> Estimate of Waste Heat that Could be Recovered with Thermoelectric Technology for Various Process Industries	210
<b>Table 6.13</b> Materials Challenges and Energy Savings Opportunities for Selected Harsh Service Conditions Application Areas	211
<b>Table 6.14</b> Energy Savings Opportunities for Selected Application Areas	212
<b>Table 6.15</b> Manufacturing Technologies Assessed in QTR Chapter 6: Innovating Clean Energy Technologies in Advanced Manufacturing	216

## Chapter 7

<b>Table 7.1</b> Market Size of U.S. Liquid Fuels and Products	229
<b>Table 7.2</b> Emerging Issues Around Hydrocarbon Production	235
<b>Table 7.3</b> Current and Future Potential Impacts of the Bioeconomy	244
<b>Table 7.4</b> Summary of Cost Contributions (\$/gallon of product) for the Algal Lipid Upgrading Design	249
<b>Table 7.5</b> Timing for Research Needs and Priorities	255
<b>Table 7.6</b> Hydrogen Delivery Cost as a Function of Dispensed Gas Pressure and Delivery Pathway as Reported from the Hydrogen Delivery Scenario Analysis Model	262
<b>Table 7.7</b> Summary of RDD&D Opportunities	269

## Chapter 8

<b>Table 8.1</b> Annual Petroleum Use and Emissions by Mode (2012)	278
<b>Table 8.2</b> Combustion and Vehicle Efficiency Impact Summary	283
<b>Table 8.3</b> Fuel-Vehicle Co-optimization Impact Summary (LDV combustion)	285
<b>Table 8.4</b> Fuel-vehicle Co-optimization Impact Summary (Lightweighting)	289

<b>Table 8.5</b> Materials Properties, Cost, and Lightweighting Potential Relative to Mild Steel	290
<b>Table 8.6</b> Vehicle Weight in a Typical Mid-size Passenger Car Without Passengers or Cargo	291
<b>Table 8.7</b> Plug-in Electric Vehicle Impact Summary	293
<b>Table 8.8</b> Fuel Cell Electric Vehicle Impact Summary	300
<b>Table 8.9</b> Status and Targets for Automotive Fuel Cell System	302
<b>Table 8.10</b> Hydrogen Storage Targets for FCEVS and Projected Hydrogen Storage System Performance for Type IV Tanks and Materials-Based Systems	304
<b>Table 8.11</b> Estimated Possible Energy Intensity Gains Through 2050 in Other Modes	307
<b>Chapter 9</b>	
<b>Table 9.1</b> Current List of DOE Designated User Facilities	330
<b>Table 9.2</b> A Subset of More Than One Hundred Shared R&D Facilities Currently Operating at DOE National Laboratories	332
<b>Table 9.3</b> 2015 ALCC Awards Relevant to Energy Technology	351
<b>Chapter 10</b>	
<b>Table 10.1</b> National Average Energy Efficiencies, Technology Shares for Each Fuel Type, and Criteria Air Pollutant Emission Factors of the U.S. Power Sector in 2010	386
<b>Table 10.2</b> Representative Land Use Energy Intensity Estimates for a Variety of Electricity Generating Technologies	388
<b>Table 10.3</b> Range of Material Requirements for Select Passenger Car Technologies	389
<b>Table 10.4</b> Range of Materials Requirements for Various Electricity Generation Technologies	390
<b>Table 10.5</b> Portfolio-Level Questions	403
<b>Table 10.6</b> Representative Criteria and Decision Questions for Systems/Technologies	403
<b>Table 10.7</b> Representative Dynamic Factors Impacting Technology RDD&D and Questions	404
<b>Table 10.8</b> Representative Metrics for Evaluating Energy Technology RDD&D	405
<b>Table 10.9</b> Notional Times Required for Stages of RDD&D	406

